

CUCINE
LUBE

GRUPPO LUBE

CREO
KITCHENS



MISCELATORI

NOBILIS



BUON LAVORO

INDEX

La forma più elevata di tecnologia, da oltre sessant'anni. Diversi modelli, sviluppo progettuale del singolo senso del bello. Ognuno, con la sua marcata identità. Ognuno, con il suo stile suggestivo. Ognuno, con la supremazia del migliore design. Tutti, con la medesima e imbattibile qualità del nostro marchio.

GARANZIA CARTUCCIA	4
CERTIFICAZIONI	6
AVANGUARDIA	8
LIVE ANTIBATTERICO	10
LEVANTE	14
MOVE	22
HERON	26
MATCH	30
FLAG	34
FLAG INOX 316 L	38
VELIS	40
LIVE	44
LIVING	48
ANTICA	60



CARTUCCIA GARANTITA 20 ANNI

LISTA COMPLETA RICAMBI: NOBILI.IT / AREA CLIENTI / B2B



Made in Italy

GARANZIA CARTUCCIA

Il nostro prodotto esprime la massima innovazione tecnologica al servizio della qualità della vita e del rispetto ambientale. Racconta l'utilizzo di materiali di prim'ordine lavorati attraverso processi all'avanguardia. Per questo siamo orgogliosi di garantire le nostre cartucce Nobili Widd® da 28 e 35 millimetri per un periodo di 20 anni.





CERTIFICAZIONI

Ogni miscelatore Nobili è progettato e realizzato all'interno dei nostri reparti: dovrà rispondere alle più severe normative internazionali, garantendo massima qualità, sicurezza e rispetto ambientale. Per maggiori informazioni relative a quali articoli dispongono di una o più certificazioni, invitiamo a consultare i relativi siti ufficiali o scrivere a qualita@nobili.it.





AVANGUARDIA

Il nostro percorso è fatto di scelte innovative e coraggiose: investire in Italia, dedicare risorse all'engineering e alla ricerca, ampliare gli stabilimenti per aumentare sempre più la capacità produttiva significa mantenere al 100% il controllo della qualità di prodotto, assicurando la più avanzata capacità nell'esprimere i processi industriali ai massimi livelli nel rispetto dello stile, della cultura e della tradizione italiana.

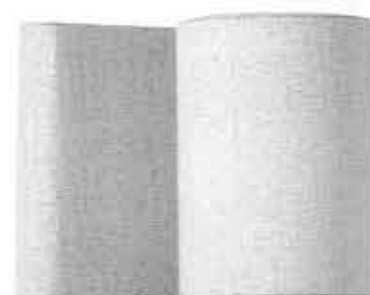



LIVE ANTIBATTERICO

CENTRO STILE NOBILI

L'avanguardia tecnica di Nobili incontra la sicurezza igienica più avanzata, per un risultato straordinario: utilizziamo la tecnologia **Biomaster, una protezione antibatterica basata sugli ioni d'argento in grado di inibire la crescita dei batteri fino al 99,99%**, diventando parte integrante del prodotto e fornendo una protezione efficace e duratura, per tutta la vita del miscelatore.

Biomaster
Antibacterial Technology





CODICE LUBE

08719038

ART. NOBILI

LV00117/1NBBM

FINITURA

Biomaster Velvet black

- Limitatore di portata con freno al 50%
- Bocca girevole 360°
- Doccetta monogetto estraibile
- Flessibili inox ø 3/8"

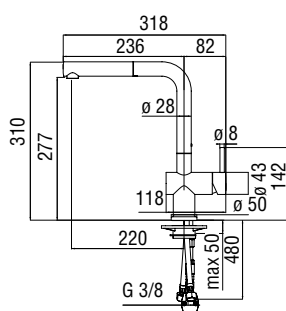

IL TRATTAMENTO È EFFICACE?

Moltissimo: il trattamento Biomaster ostacola la proliferazione batterica fino al 99,99%. Si tratta di una tecnologia avanzata a base di ioni d'argento, la cui efficacia è riconosciuta da avanzati studi scientifici.

IL RISULTATO È CERTIFICATO?

Sì, abbiamo eseguito alcune prove presso il laboratorio 3A LABORATORI S.r.l. di Padova: i test sono stati condotti in conformità alla norma tecnica ISO 22196:2011 ed hanno dimostrato una elevatissima percentuale di abbattimento dell'attività batterica (Staphylococcus aureus 99,87% / Escherichia coli 99,99%).

QUANTO SONO VERITIERI QUESTI TEST?

La veridicità dei test è attestata dal fatto che 3A LABORATORI S.r.l. è accreditato ACCREDIA con il numero 1165. ACCREDIA è l'Ente Unico Italiano di Accreditamento e fa parte del circuito internazionale ILAC-MRA, al quale aderiscono i maggiori Enti certificativi al mondo, riconoscendo mutualmente le prove eseguite in regime di accreditamento.

QUANTO DURA L'EFFICACIA DEL TRATTAMENTO?

Il trattamento si considera efficace per l'intero ciclo di vita del miscelatore, ha superato i test in nebbia salina neutra (200 h) ed è privo di effetti nocivi: la finitura superficiale non subisce alterazioni dal punto di vista estetico, nè presenta odori diversi rispetto allo standard.

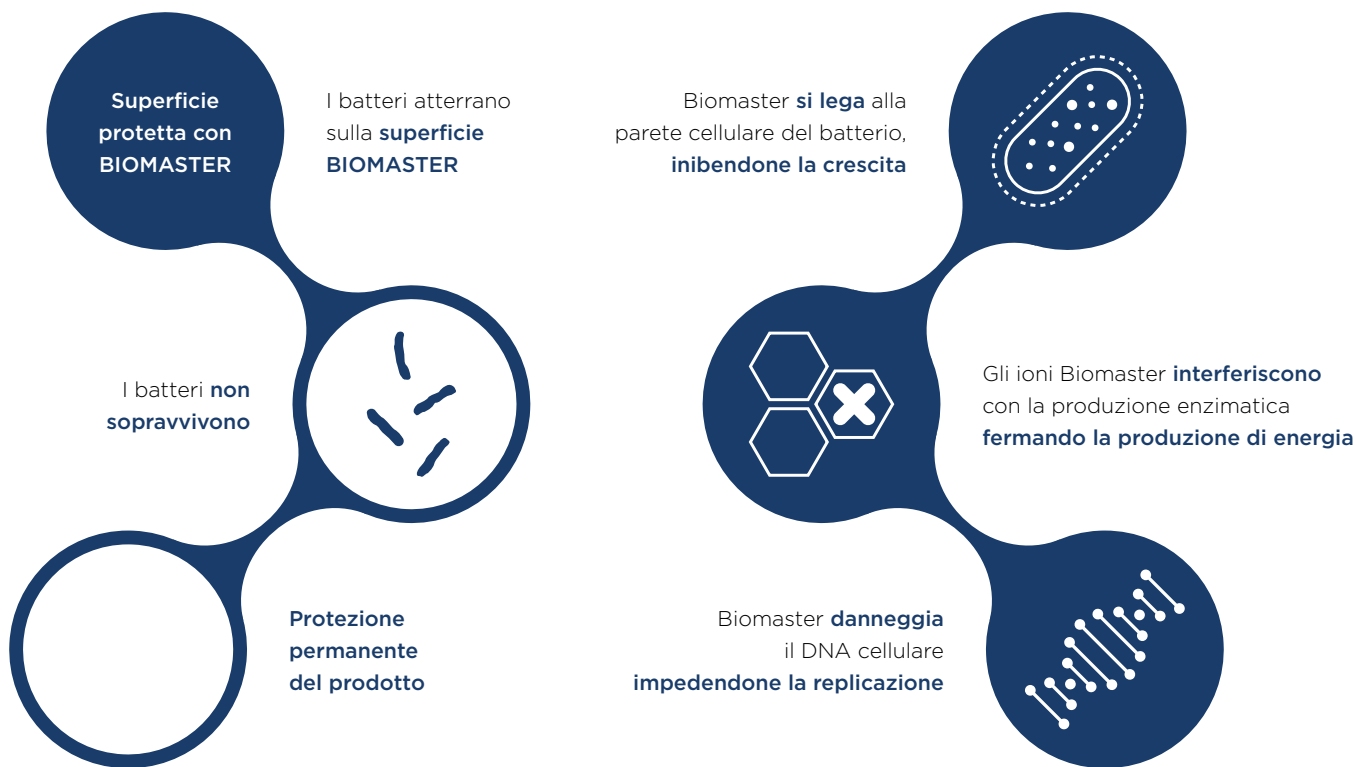

COS'È BIOMASTER?

Biomaster è una polvere antimicrobica agli ioni d'argento per il controllo della crescita di microbi su substrati trasparenti senza alterare il colore o l'opacità. La natura inorganica, le piccole dimensioni delle particelle e la tolleranza alle alte temperature di questo additivo lo rendono ideale per l'uso in un'ampia gamma di applicazioni.

COME FUNZIONA BIOMASTER?

L'agente antimicrobico Biomaster si basa sulla tecnologia degli ioni d'argento e ha tre modalità di azione. Quando i batteri entrano in contatto con una superficie protetta con Biomaster, gli ioni d'argento impediscono loro di crescere, di produrre energia o riprodursi, quindi muoiono. La protezione di Biomaster è incredibilmente resistente, di lunga durata ed altamente attiva. Quando viene aggiunto, si disperde in tutta la massa e diventa parte integrante del prodotto. L'argento è inorganico e, a differenza delle tecnologie antimicrobiche organiche, rimane all'interno dell'elemento trattato cui viene aggiunto. Il principio attivo fornisce pertanto la massima protezione antibatterica per tutta la vita utile del prodotto trattato.



Biomaster è un prodotto di Addmaster Ltd, con sede nel Regno Unito, fornitore leader nella tecnologia antibatterica per il settore plastico, cartaceo, tessile, dei rivestimenti e delle vernici. Gli additivi antimicrobici Biomaster sono esportati a livello globale e l'azienda è stata riconosciuta e premiata dal prestigioso «Queens Award for Enterprise in International Trade». Si tratta dell'unica azienda fornitrice di additivi antimicrobici che ha ottenuto questa prestigiosa onorificenza. Per ulteriori informazioni consulti il sito web addmaster.co.uk

LEVANTE



MARCO VENZANO

Un amore immediato, a 360°: l'indole intuitiva di Levante evoca comfort e semplicità di utilizzo. L'ampio raggio d'azione della doccetta, collocata in posizione opposta rispetto ai miscelatori tradizionali, unito alla facilità di prelevarla con una sola mano in virtù dell'ancoraggio magnetico, permettono la più totale libertà di movimento sul piano livello.







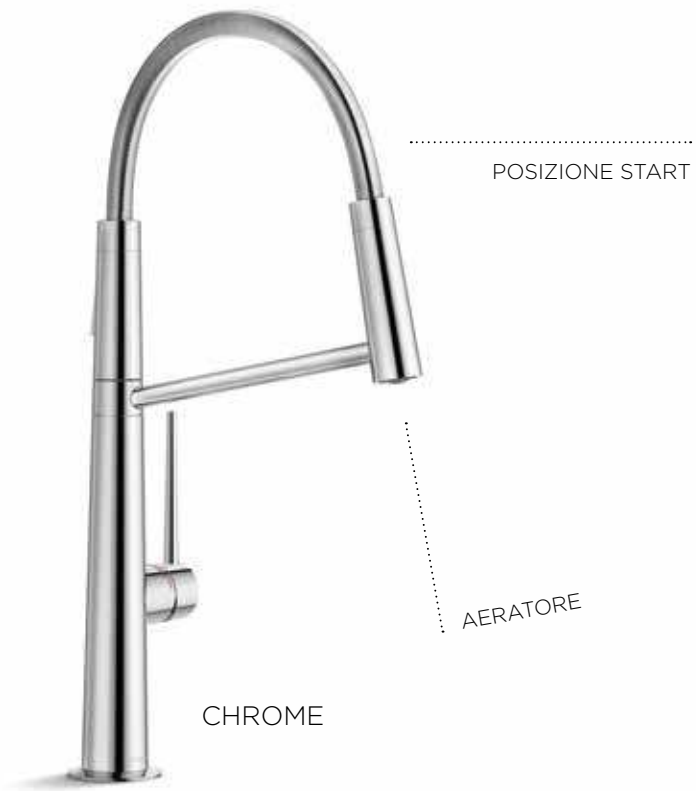

ANCORAGGIO MAGNETICO

DIAMOND SMOKE PVD

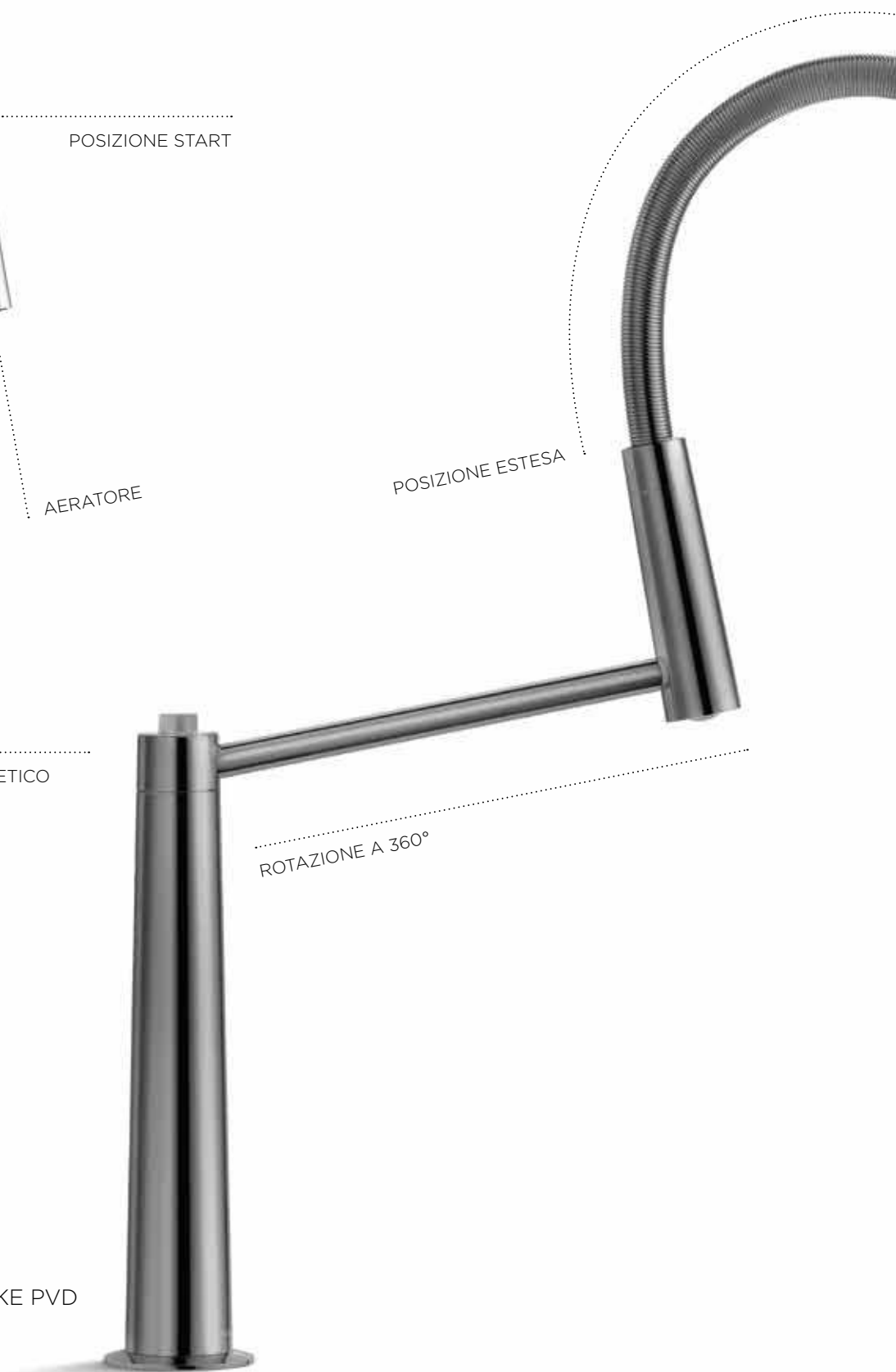



RAGGIO D'AZIONE
RADDOPPIATO

DOCETTA

VELVET BLACK



INOX

APERTURA IN ACQUA FREDDA
CON LIMITATORE DI PORTATA

CODICE LUBE

08719070

ART. NOBILI

MV123300CR

FINITURA

Chrome

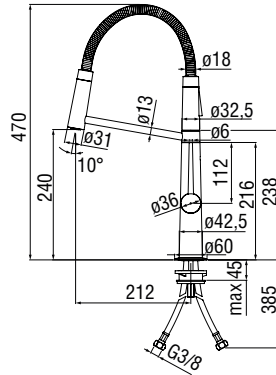

- Limitatore di energia con apertura in acqua fredda
- Limitatore di portata con freno al 50%
- Bocca girevole 360°
- Aeratore anticalcare M 24 x 1
- Doccetta orientabile 360° ad appoggio magnetico
- Flessibili inox \varnothing 3/8"



CODICE LUBE

08719071

ART. NOBILI

MV123300IX

FINITURA

Inox

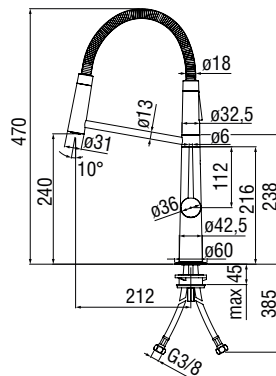

- Limitatore di energia con apertura in acqua fredda
- Limitatore di portata con freno al 50%
- Bocca girevole 360°
- Aeratore anticalcare M 24 x 1
- Doccetta orientabile 360° ad appoggio magnetico
- Flessibili inox \varnothing 3/8"



CODICE LUBE

08719072

ART. NOBILI

MV123300BM

FINITURA

Velvet black

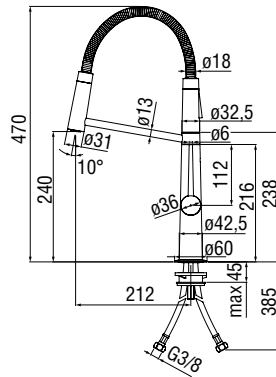

- Limitatore di energia con apertura in acqua fredda
- Limitatore di portata con freno al 50%
- Bocca girevole 360°
- Aeratore anticalcare M 24 x 1
- Doccetta orientabile 360° ad appoggio magnetico
- Flessibili inox \varnothing 3/8"



CODICE LUBE

08719073

ART. NOBILI

MV123300FLP

FINITURA

Diamond smoke PVD

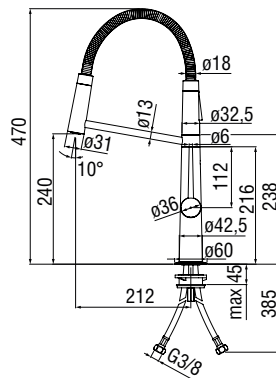

- Limitatore di energia con apertura in acqua fredda
- Limitatore di portata con freno al 50%
- Bocca girevole 360°
- Aeratore anticalcare M 24 x 1
- Doccetta orientabile 360° ad appoggio magnetico
- Flessibili inox \varnothing 3/8"



MOVE



MARCO VENZANO

Move ridisegna il miscelatore lavello rivoluzionandone il concetto: l'inedito centro di rotazione anteriore duplica il raggio d'azione del miscelatore. Intuizione e innovazione: il sistema ad attrazione magnetica privo di ganci e supporti permette di prelevare e utilizzare la doccetta con una sola mano, migliorandone l'ergonomia.





CODICE LUBE

08719095

ART. NOBILI

MV92300/50CR

FINITURA

Chrome

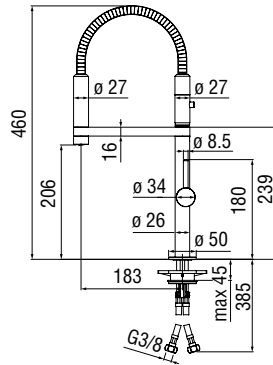

- Limitatore di portata con freno al 50%
- Bocca girevole 360°
- Aeratore anticalcare M 24 x 1
- Doccetta orientabile 360° ad appoggio magnetico
- Flessibili inox \varnothing 3/8"



CODICE LUBE

08719096

ART. NOBILI

MV92400/50BM

FINITURA

Velvet black

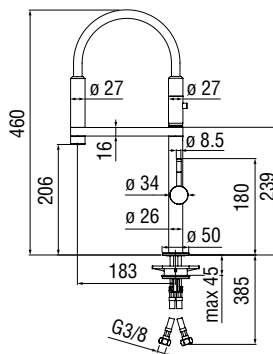

- Limitatore di portata con freno al 50%
- Bocca girevole 360°
- Aeratore anticalcare M 24 x 1
- Doccetta orientabile 360° ad appoggio magnetico
- Flessibili inox \varnothing 3/8"





HERON

CENTRO STILE NOBILI

Equilibrio e leggerezza d'insieme, vestiti da un abito minimale ed elegante, senza tempo. Elementi iconici e dettagli ricercati, sottolineati dalla verniciatura in Velvet black, evidenziano la linearità della forma slanciata, frutto dell'adozione della cartuccia Nobili Widd® nella sua versione più recente con miscelazione assiale.

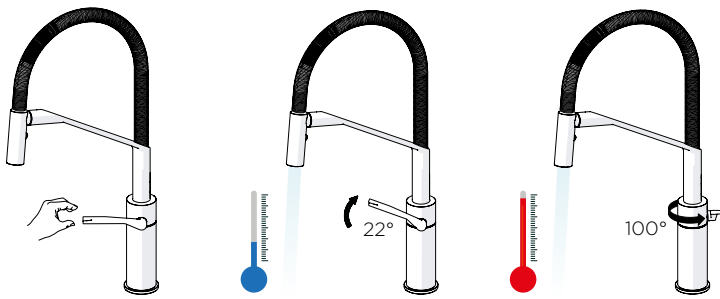



CODICE LUBE

08719090

ART. NOBILI

HR125300CB

FINITURA

Chrome and Velvet black

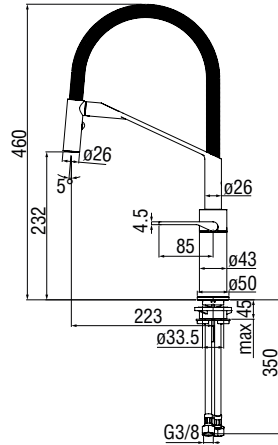

- Limitatore di energia con apertura in acqua fredda
- Bocca girevole 360°
- Doccetta a 2 getti orientabile
- Flessibili inox \varnothing 3/8"

CODICE LUBE

08719091

ART. NOBILI

HR125300IB

FINITURA

Inox and Velvet black

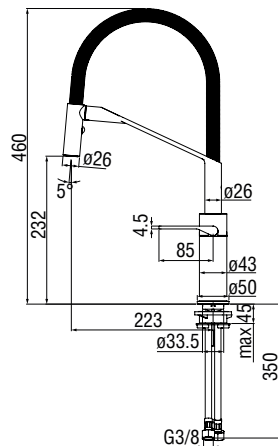

- Limitatore di energia con apertura in acqua fredda
- Bocca girevole 360°
- Doccetta a 2 getti orientabile
- Flessibili inox \varnothing 3/8"



MATCH



CENTRO STILE NOBILI

Non sono solo gli occhi ad essere attratti dalla nuova collezione Match: la razionalità e il design varcano i limiti della progettazione cucina. Tra estetica e performance, tra emozione e tecnica, tra semplicità e creatività, Nobili si proietta verso il futuro, ponendosi in prima linea nello sviluppo di rivestimenti sempre più carismatici.

FENIX





CHOOSE YOUR FENIX NTM®

FENIX

Dona il tocco che preferisci per esaltare il temperamento attraverso i dettagli. Configura il miscelatore Match combinando la finitura del corpo al rivestimento Fenix NTM® che maggiormente si presta all'arredo della tua cucina: lasciati trasportare dall'opacità più sopraffina ed intensa e vivi l'esperienza tattile inconfondibile di questo laminato. Ogni scelta è perfetta proprio perchè ideata tenendo a mente il cliente.

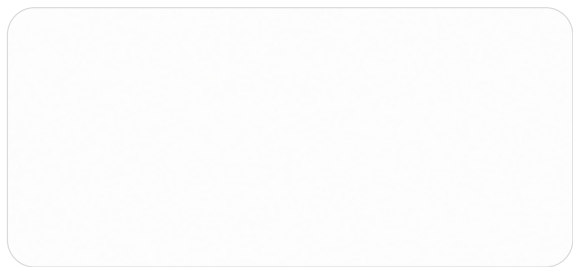

BIANCO KOS



ZINCO DOHA



GRIGIO LONDRA

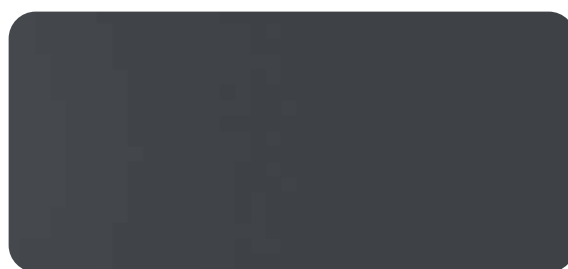

GRIGIO BROMO



ROSSO JAIPUR



NERO INGO

FLAG



CENTRO STILE NOBILI

Pensiero razionale e desiderio di funzionalità si muovono in coerenza tra loro, le geometrie precise dei componenti si proiettano nell'equilibrio stilistico complessivo, che determina il purismo lineare del miscelatore. Flag rivela un design moderno ed elegante in perfetta armonia con il design delle cucine moderne.





CODICE LUBE

08719025

08719026

ART. NOBILI

FL96137CR

FL96137NC

FINITURA

Chrome

Black and Chrome

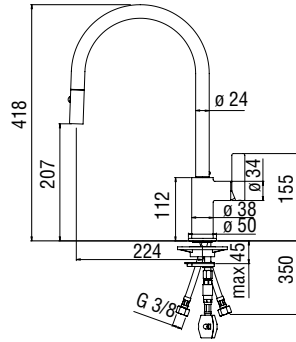

- Limitatore di portata con freno al 50%
- Bocca girevole
- Doccetta a 2 getti estraibile
- Flessibili inox \varnothing 3/8"

CODICE LUBE

08719020

08719021

ART. NOBILI

FL96113CR

FL96113NC

FINITURA

Chrome

Black and Chrome

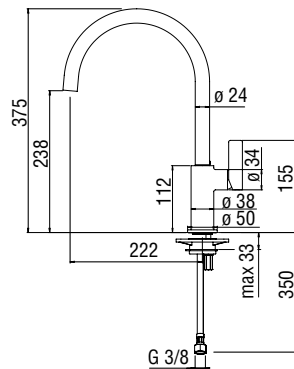

- Limitatore di portata con freno al 50%
- Bocca girevole 360°
- Aeratore anticalcare M 21,5 x 1
- Flessibili inox \varnothing 3/8"

CODICE LUBE

08719033

ART. NOBILI

FL96300/50CR

FINITURA

Chrome

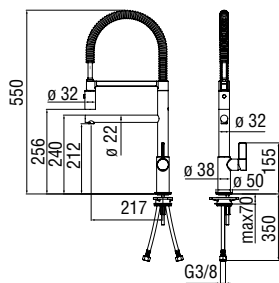

- Limitatore di portata con freno al 50%
- Bocca girevole 360°
- Aeratore anticalcare M 18 x 1
- Doccetta monogetto orientabile
- Flessibili inox \varnothing 3/8"



20
YEARS

GARANZIA
CARTUCCIA

CODICE LUBE

08719032

ART. NOBILI

FL96400/1CR

FINITURA

Chrome

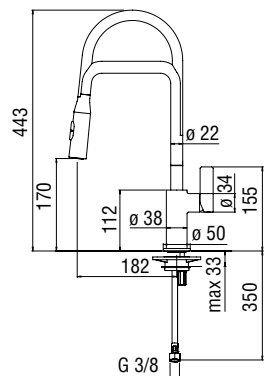

- Limitatore di portata con freno al 50%
- Bocca girevole 360°
- Doccetta a 2 getti orientabile
- Flessibili inox \varnothing 3/8"



20
YEARS

GARANZIA
CARTUCCIA

CODICE LUBE

08719027

ART. NOBILI

FL961371P

MATERIALE

Inox 316 L

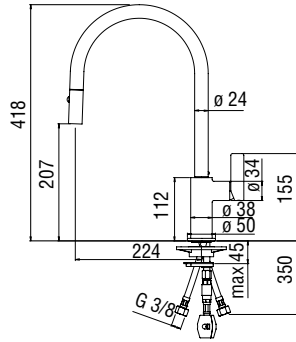

- Limitatore di portata con freno al 50%
- Bocca girevole
- Doccetta a 2 getti estraibile
- Flessibili inox \varnothing 3/8"

CODICE LUBE

08719022

ART. NOBILI

FL961131P

MATERIALE

Inox 316 L

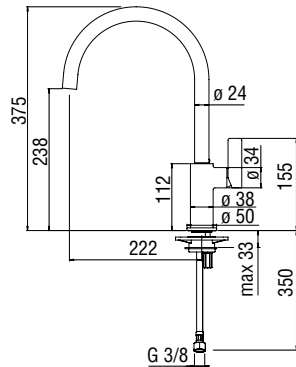

- Limitatore di portata con freno al 50%
- Bocca girevole 360°
- Aeratore anticalcare M 21,5 x 1
- Flessibili inox \varnothing 3/8"

CODICE LUBE

08719030

ART. NOBILI

FL961331P

MATERIALE

Inox 316 L

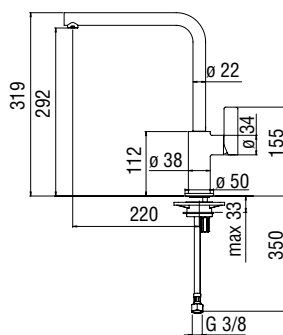

- Limitatore di portata con freno al 50%
- Bocca girevole 360°
- Aeratore anticalcare M 18 x 1
- Flessibili inox \varnothing 3/8"

CODICE LUBE

08719031

ART. NOBILI

FL961271P

MATERIALE

Inox 316 L

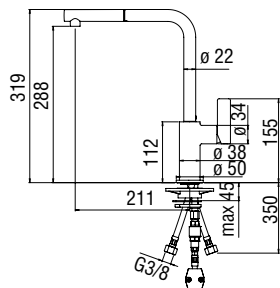

- Limitatore di portata con freno al 50%
- Bocca girevole
- Doccetta monogetto estraibile
- Flessibili inox \varnothing 3/8"

VELIS



CENTRO STILE NOBILI

Puro minimalismo. Pura tecnologia. Pura libertà. Velis celebra l'inizio del nuovo decennio attraverso una linea senza tempo, segnando marcatamente il confine con il passato: la cartuccia Nobili Widd® nella sua versione più recente con miscelazione assiale permette un inedito e straordinario equilibrio tra forma e avanguardia.

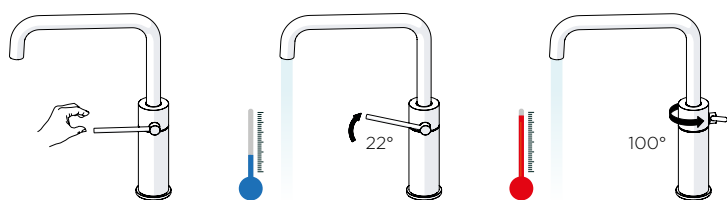



CODICE LUBE

08719065

ART. NOBILI

VE125133CR

FINITURA

Chrome

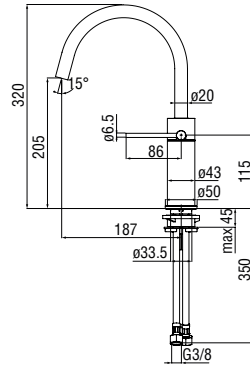

- Limitatore di energia con apertura in acqua fredda
- Bocca girevole 360°
- Aeratore anticalcare M 18 x 1, portata 5 l/m
- Flessibili inox \varnothing 3/8"

CODICE LUBE

08719066

ART. NOBILI

VE125134CR

FINITURA

Chrome

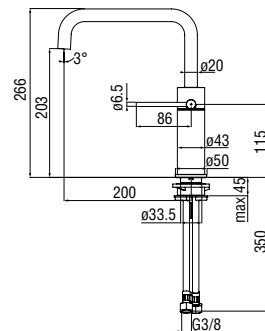

- Limitatore di energia con apertura in acqua fredda
- Bocca girevole 360°
- Aeratore anticalcare M 18 x 1, portata 5 l/m
- Flessibili inox \varnothing 3/8"



LIVE



CENTRO STILE NOBILI

I tratti intramontabili di Live si esprimono in tutta la loro spettacolarità nella finitura cromata, una prospettiva intelligente e funzionale, dal design senza eccessi che non rinuncia alla comodità. Modernità, eleganza e funzionalità sono le parole chiave per descrivere linee senza tempo.

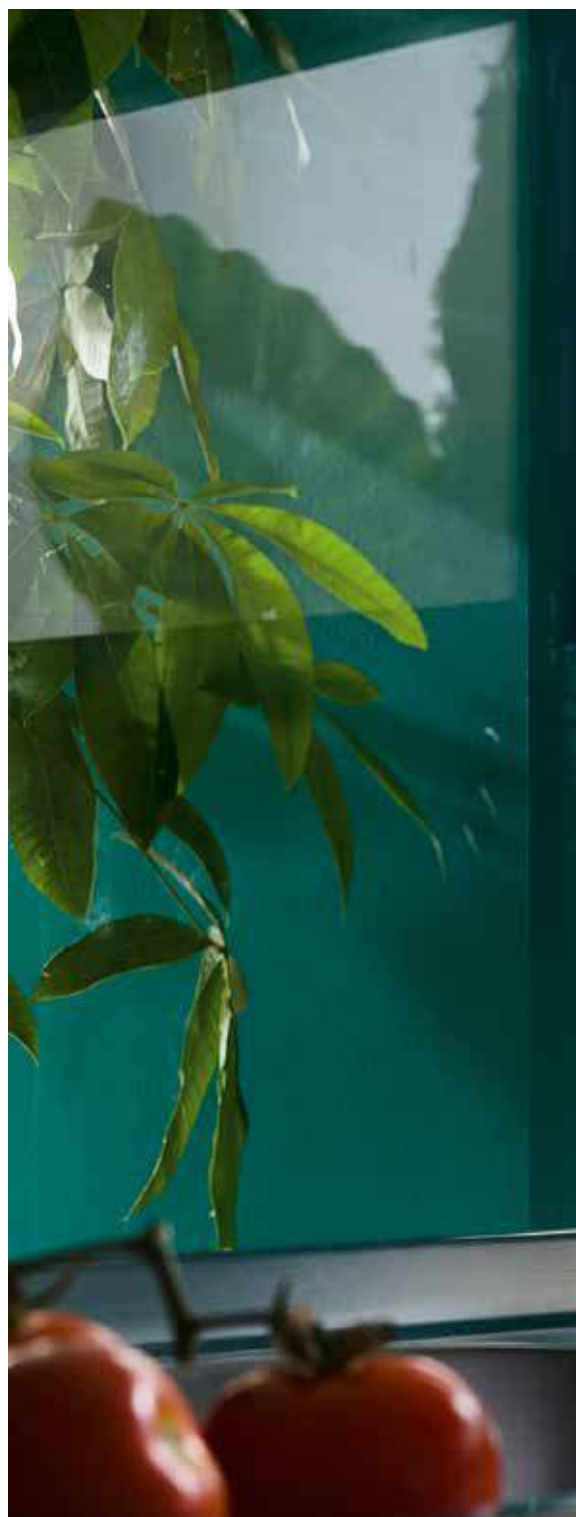



CODICE LUBE

08719047

08719048

ART. NOBILI

LV00133CR

LV00133BM

FINITURA

Chrome

Velvet black

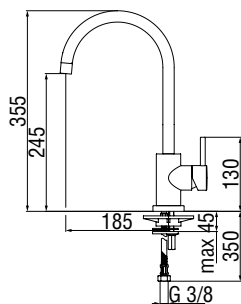

- Limitatore di portata con freno al 50%
- Bocca girevole 360°
- Aeratore anticalcare M 16 x 1
- Flessibili inox \varnothing 3/8"

**CODICE LUBE**

08719049

ART. NOBILI

LV00137/1CR

FINITURA

Chrome

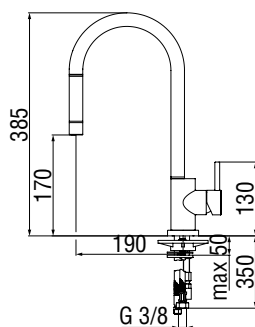

- Limitatore di portata con freno al 50%
- Bocca girevole
- Doccetta monogetto estraibile
- Flessibili inox \varnothing 3/8"



CODICE LUBE

08719040

08719041

08719042

ART. NOBILI

LV00113CR

LV00113IX

LV00113BM

FINITURA

Chrome

Inox

Velvet black

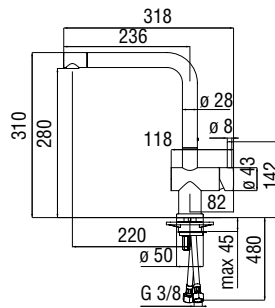

- Limitatore di portata con freno al 50%
- Bocca girevole 360°
- Aeratore anticalcare M 24 x 1
- Flessibili inox \varnothing 3/8"

CODICE LUBE

08719043

08719044

08719045

ART. NOBILI

LV00117CR

LV00117/1IX

LV00117/1BM

FINITURA

Chrome

Inox

Velvet black

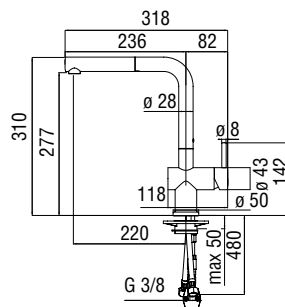

- Limitatore di portata con freno al 50%
- Bocca girevole 360°
- Doccetta monogetto estraibile
- Flessibili inox \varnothing 3/8"

LIVING



CENTRO STILE NOBILI

Le collezioni cucina Living, dalle forme semplici e sincere, rappresentano la scelta ideale per la quotidianità, dove ergonomia e affidabilità giocano un ruolo primario sul piano lavello.





CODICE LUBE

08719100

ART. NOBILI

OZ45300/3CR

FINITURA

Chrome

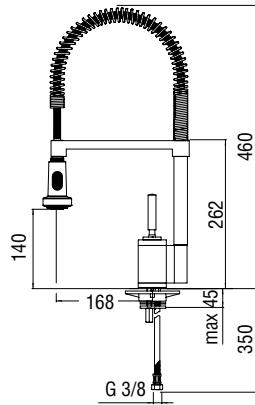

BILLY

- Corpo girevole
- Bocca girevole 360°
- Doccetta a 2 getti orientabile
- Flessibili inox \varnothing 3/8"

CODICE LUBE

08719008

ART. NOBILI

CU92813CR

FINITURA

Chrome

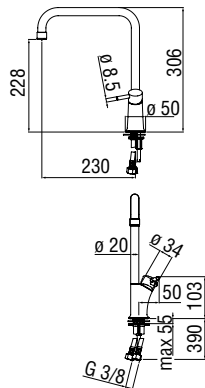

CUCI

- Limitatore di portata con freno al 50%
- Bocca girevole 360°
- Aeratore anticalcare M 22 x 1
- Flessibili inox \varnothing 3/8"





CODICE LUBE

08719075

08719076

ART. NOBILI

SN00713CR

SN00713IX

FINITURA

Chrome

Inox

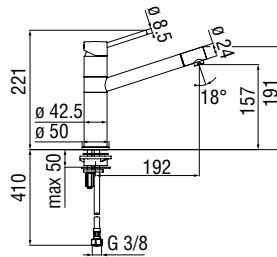
**SNOW**

- Limitatore di portata con freno al 50%
- Bocca girevole 360°
- Aeratore anticalcare M 18 x 1
- Flessibili inox \varnothing 3/8"

CODICE LUBE

08719077

08719078

ART. NOBILI

SN00717CR

SN00717IX

FINITURA

Chrome

Inox

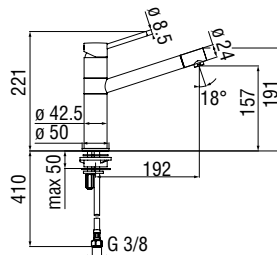
**SNOW**

- Limitatore di portata con freno al 50%
- Bocca girevole
- Doccetta monogetto estraibile
- Flessibili inox \varnothing 3/8"

CODICE LUBE

08719083

ART. NOBILI

RDE0123/1T7CR

FINITURA

Chrome

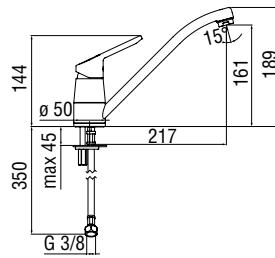

NEW ROAD T7

- Limitatore di energia con apertura in acqua fredda
- Limitatore di portata con freno al 50%
- Corpo girevole 360°
- Aeratore anticalcare M 24 x 1
- Aeratore 5l/min incluso nella confezione
- Flessibili inox \varnothing 3/8"

CODICE LUBE

08719084

ART. NOBILI

RD00127/1T7CR

FINITURA

Chrome

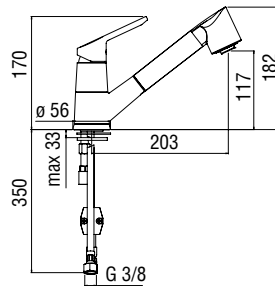

NEW ROAD T7

- Limitatore di portata con freno al 50%
- Bocca girevole
- Doccetta a 2 getti estraibile
- Flessibili inox \varnothing 3/8"



CODICE LUBE

08719080

ART. NOBILI

RD00117CR

FINITURA

Chrome

NEW ROAD

- Limitatore di portata con freno al 50%
- Corpo girevole
- Doccetta monogetto estraibile
- Flessibili inox \varnothing 3/8"

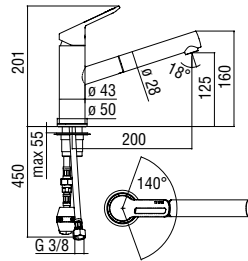

CODICE LUBE

08719081

ART. NOBILI

RD00113/25CR

FINITURA

Chrome

NEW ROAD

- Limitatore di portata con freno al 50%
- Bocca girevole 360°
- Aeratore anticalcare M 24 x 1
- Flessibili inox \varnothing 3/8"

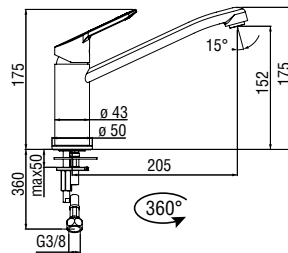

CODICE LUBE

08719082

ART. NOBILI

RD00113/60CR

FINITURA

Chrome

NEW ROAD

- Limitatore di portata con freno al 50%
- Bocca girevole 360°
- Aeratore anticalcare M 24 x 1
- Flessibili inox \varnothing 3/8"

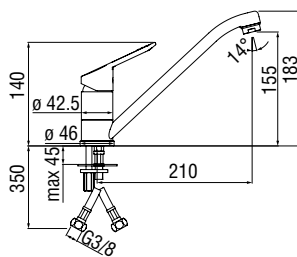

20
YEARS

GARANZIA
CARTUCCIA

CODICE LUBE

08719006

ART. NOBILI

BS101113CR

FINITURA

Chrome

BLUES

- Limitatore di portata con freno al 50%
- Bocca girevole 360°
- Aeratore anticalcare M 22 x 1
- Flessibili inox \varnothing 3/8"

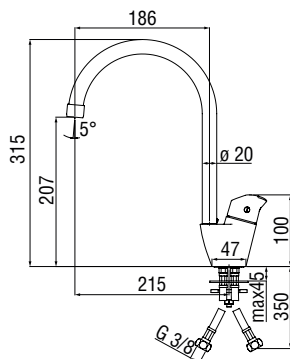

CODICE LUBE

08719035

ART. NOBILI

MJ16113CR

FINITURA

Chrome

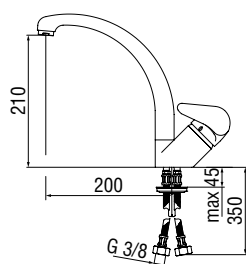

MISTRAL JUNIOR

- Limitatore di portata con freno al 50%
- Bocca girevole 360°
- Aeratore anticalcare M 24 x 1
- Flessibili inox \varnothing 3/8"

CODICE LUBE

08719036

ART. NOBILI

MJ16117CR

FINITURA

Chrome

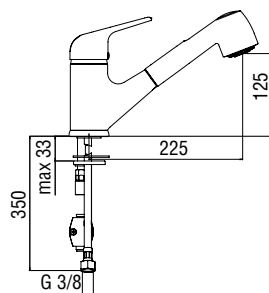

MISTRAL JUNIOR

- Limitatore di portata con freno al 50%
- Corpo girevole 360°
- Doccetta a 2 getti estraibile
- Flessibili inox \varnothing 3/8"

CODICE LUBE

08719000

ART. NOBILI

AQ93114CR

FINITURA

Chrome

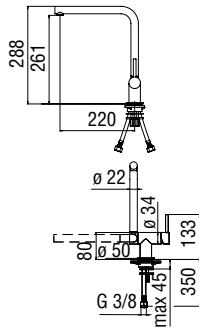

ACQUERELLI SOTTOFINESTRA

- Limitatore di portata con freno al 50%
- Bocca girevole 360°
- Aeratore anticalcare M 18 x 1
- Flessibili inox \varnothing 3/8"

CODICE LUBE

08719005

ART. NOBILI

AS11113/ICCR

FINITURA

Chrome

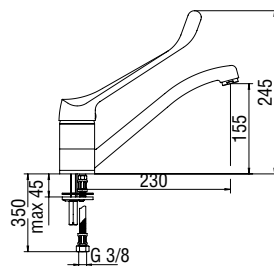

SKIPPER LEVA CLINICA

- Bocca girevole 360°
- Aeratore anticalcare M 24 x 1
- Flessibili inox \varnothing 3/8"

ANTICA



CENTRO STILE NOBILI

Lo stile retrò fa da cornice ad un miscelatore d'eccezione: dolcezza e libertà di movimento elevano Antica ad un oggetto d'arredo senza tempo. Linee disegnate con la cura e la passione artigianale: tratti e dettagli ornamentali profondamente intensi raccontano la più elevata manifestazione d'eleganza.





CODICE LUBE

08719010

08719011

08719012

ART. NOBILI

AT18117CR

AT18117BR

AT18117RA

FINITURA

Chrome

Ancient bronze

Tuscany red

- Bocca girevole 360°
- Aeratore anticalcare M 22 x 1
- Flessibili inox ø 3/8"

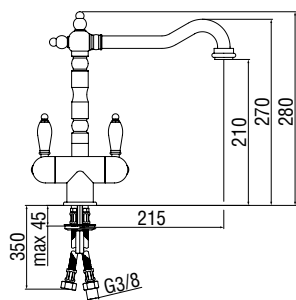
**CODICE LUBE**

08719015

08719016

08719017

ART. NOBILI

AT18113CR

AT18113BR

AT18113RA

FINITURA

Chrome

Ancient bronze

Tuscany red

- Bocca girevole 360°
- Aeratore anticalcare M 22 x 1
- Flessibili inox ø 3/8"

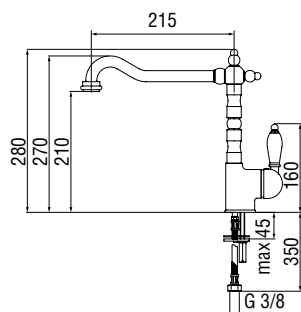



ASSISTENZA TECNICA

Alessandro Sacchi

0322.885881

supporto@nobili.it

CARLO NOBILI SPA RUBINETTERIE

via novara 29

28019 suno (no) italia

nobili.it

RESPONSABILE DIVISIONE CUCINA

Luca Fava Piz

+39 345 4891987

l.favapiz@nobili.it

AREA MANAGER ITALIA

Andrea Fava Piz

+39 340 2699748

a.favapiz@nobili.it

NOBILIS



LUBE INDUSTRIES SRL

Via dell'Industria, 4 - 62010 Treia (MC) Italia
Tel. centralino 0733 8401 (r.a.)
Fax 0733 840222 - 0733 840333
info@cucinelube.it - www.cucinelube.it
info@creokitchens.it - www.creokitchens.it

La Lube Industries srl è dotata di Sistemi di Gestione per la Qualità, la Salute e Sicurezza, in conformità alle norme UNI EN ISO 9001 e BS OHSAS 18001. Per maggiori informazioni visita il nostro sito www.cucinelube.it