





creativa®

PROGETTO
"CREATIVA"

MULTI COMPONENTI UNITA'
SISTEMA ANTE

SENDOVE VERTICALE AIA

GEOMETRIE IN MOVIMENTO CHE RENDONO UNICA LA TUA CUCINA. CREATIVA È UN PROGRAMMA DI ARREDO PER CHI VUOLE PROGETTARE E PENSARE IL PROPRIO SPAZIO ABITATIVO IN MODO PERSONALE E QUINDI ESCLUSIVO. GIOCHI DI COLORI, DI MATERIALI E DI FORME PER UNA CREATIVITÀ SENZA FINE.

SMOOTH GEOMETRIES WHICH MAKES YOUR KITCHEN UNIQUE. CREATIVA IS A FURNISHING PROGRAM FOR THOSE WHO DESIRE TO PROJECT AND PERSONALIZE THEIR LIVING SPACE AND TO HAVE IT EXCLUSIVE. A FINE MOVEMENT OF COLOURS, MATERIALS AND SHAPES FOR AN ENDLESS CREATIVITY.

IMPIALLACCIATO
+ LACCATO
VENEERED + LACQUERED

MELAMINICO ROVERE
+ LACCATO
MELAMINE OAK + LACQUERED

MELAMINICO EFFETTO MALTA
+ LACCATO
MELAMINE MORTAR EFFECT + LACQUERED

LACCATO
+ LACCATO
LACQUERED + LACQUERED

IL DESIGN DEL MODELLO **creativa**® È STATO REGISTRATO E DEPOSITATO. LA TUTELA È GARANTITA DAL OHIM COMUNITARIO E APPLICATA NEI 27 STATI MEMBRI DELL' UNIONE EUROPEA.

THE DESIGN REGISTRATION FOR THE **creativa**® MODEL HAS BEEN GRANTED BY THE OHIM AND NOW APPLIES IN ALL OF THE 27 EU MEMBER STATES.







L'EFFETTO MALTA JUTA, UNITO AL MELAMINICO VISIONE OPACO ED AI TOCCHI DI LACCATO VERDE POSITANO, CONFERISCE ALLA COMPOSIZIONE UN SAPORE CALDO E NATURALE, TRASMETTENDO ALL'AMBIENTE E A CHI LO VIVE TUTTA L'ENERGIA E LA MATERICITÀ DELLA TERRA.

THE MORTAR JUTE EFFECT TOGETHER WITH THE MATT MINK MELAMINE FINISH AND THE POSITANO GREEN LACQUERED ACCENTS GIVE THE WHOLE COMPOSITION A NATURAL AND WARM FEEL, INFUSING THE SURROUNDS WITH THE NATURAL ENERGY AND TEXTURE ASSOCIATED WITH THE EARTH.





ANTE BASI /
MALTA JUTA+
LACCATO VISONE OPACO

TOP BASI /
LACCATO VISONE OPACO

PENSILI /
LACCATO VISONE OPACO

ELEMENTO A GIORNO /
LACCATO VERDE POSITANO OPACO

BASE UNITS /
JUTE MORTAR +
MATT LACQUERED MINK

BASE TOP /
MATT LACQUERED MINK

WALL UNITS /
MATT LACQUERED MINK

OPEN UNITS /
MATT LACQUERED POSITAN GREEN

ANTE / DOORS



MALTA JUTA + VISIONE OPACO
JUTE MORTAR + MATT MINK



LACCATO VERDE POSITANO OPACO
MATT LACQUERED POSITAN GREEN

TOP / WORKTOP



LAMINATO H2 E H4
OLD DARK FINITURA URBAN ABS 1
LAMINATED H2 AND H4
OLD DARK FINISH URBAN ABS 1

ZOCCOLO / PLINTH



IN PVC LACCATO VISIONE OPACO
PVC PLINTHS LACQUERED MATT MINK

LIBRERIA / BOOKSCASE



LACCATO VERDE POSITANO
LACQUERED POSITAN GREEN



MELAMINICO VISIONE
MELAMINE MINK

SEDIA / CHAIR - SPINDEL



SEDUTA TORTORA E
GAMBE IN ROVERE SMOKE
DOVE GREY SEAT WITH
SMOKE OAK LEGS

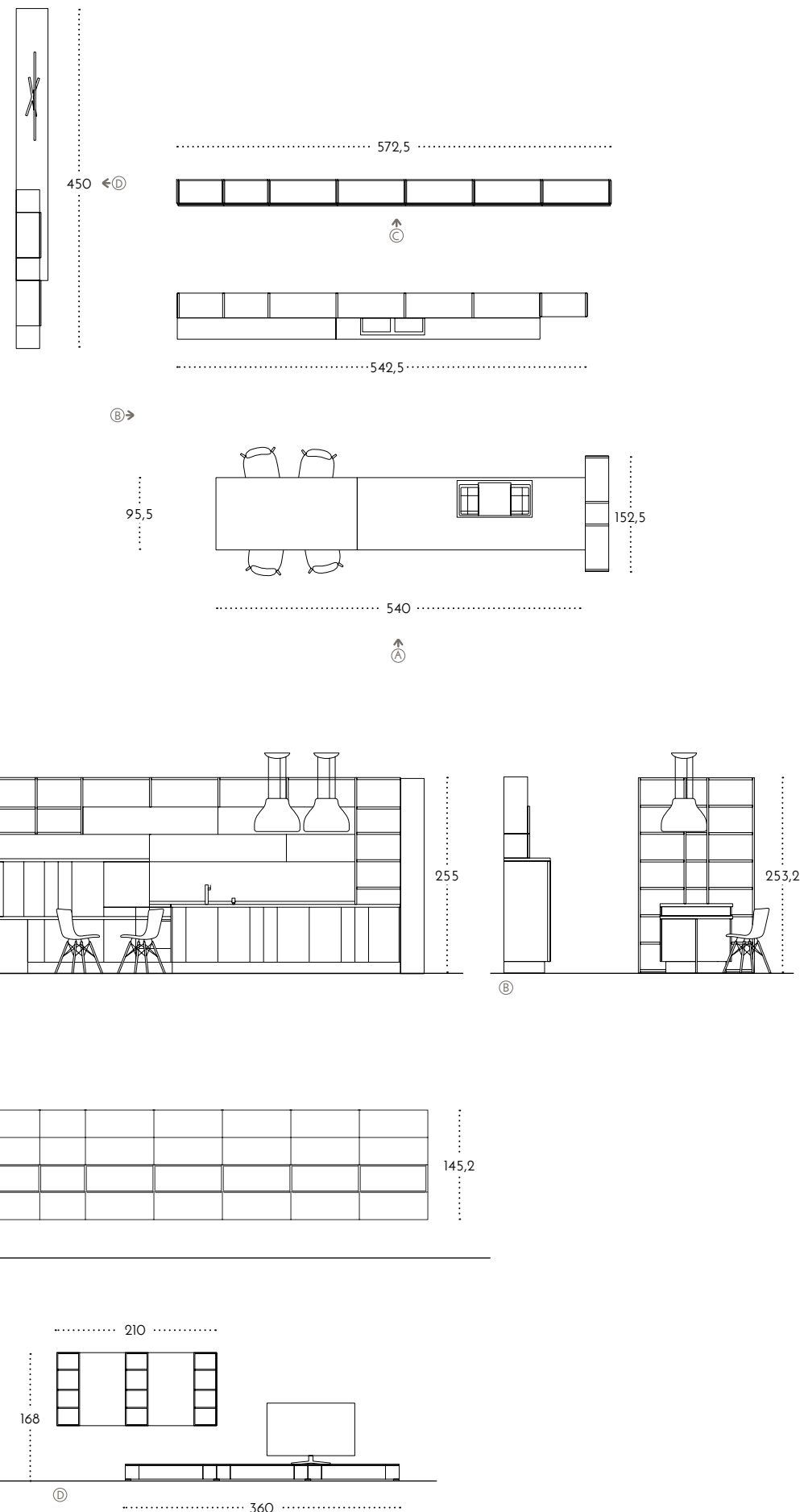





LA LIBRERIA INTERPARETE SI INTEGRA PERFETTAMENTE CON IL BLOCCO DELLE COLONNE, CREANDO COSÌ UN FILTRO CHE SEPARA L'AMBIENTE CUCINA DA QUELLO DEL LIVING.

THE DIVIDING SHELVES BLEND IN MAGNIFICENTLY WITH THE TALL UNITS, CREATING AN ELEGANT PARTITION BETWEEN THE KITCHEN ZONE AND THE LIVING AREA.





ANTE / DOORS



MALTA LAVAGNA +
LAVAGNA OPACO
SLATE GREY MORTAR +
MATT SLATE GREY



VETRO SATINATO LAVAGNA
MATT GLASS SLATE GREY

TOP / WORKTOP



VETRO LAVAGNA
SLATE GREY GLASS



IMPIALLACCIATO
ROVERE COGNAC CON NODINI
VENEERED COGNAC OAK WITH KNOTS

ZOCCOLO / PLINTH



IN PVC LACCATO
LAVAGNA OPACO
PVC PLINTHS LACQUERED MATT
SLATE GREY

LIBRERIA / BOOKSCASE



MELAMINICO LAVAGNA
MELAMINE SLATE GREY

SGABELLO / STOOL - SAW



NERO
BLACK

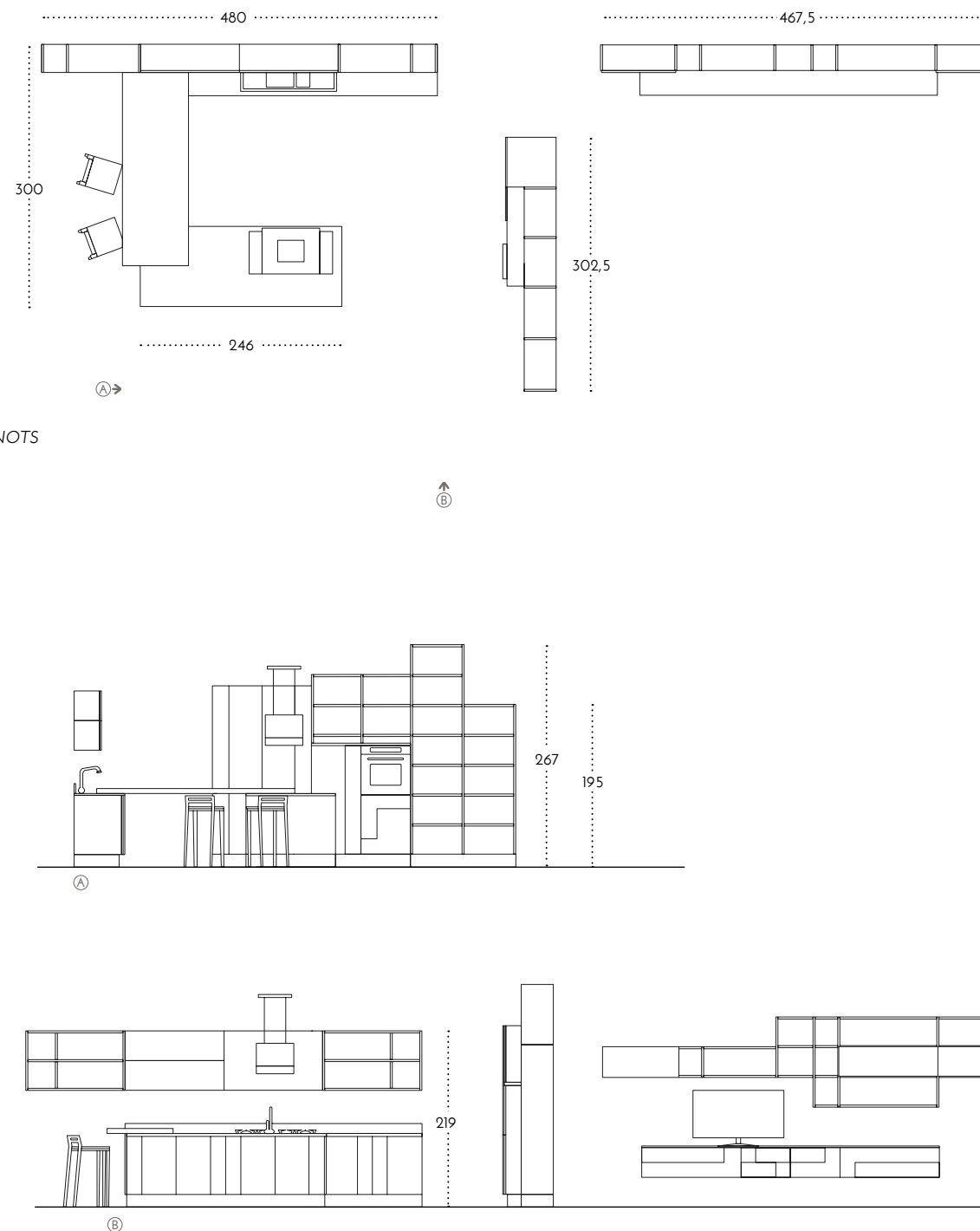





L' ISOLA È COLLEGATA ALLA PARETE TRAMITE IL PIANO IN FORTE SPESSORE CARATTERIZZATO DA UNA FINITURA DALLA DECISA MATERICITÀ. IL TERMINALE CON ELEMENTI A GIORNO, IN LACCATO FUMO, FORNISCE PRATICHE NICCHIE PER IL CONTENIMENTO.

THE ISLAND IS ATTACHED TO THE WALL AND FEATURES A THICK TABLE TOP WITH A BOLDLY TEXTURED FINISH. THE END UNIT WITH ITS OPEN CABINETS FEATURES A SMOKY LACQUERED FINISH AND HANDY STORAGE RECESSES.



TROVIAMO QUI, INSERITO NELLA COMPOSIZIONE, IL SISTEMA DI ACCESSORI INTEGRATI ALLA BARRA SOTTO PENSILE: ELLE SYSTEM. LA LINEA OFFRE VARI ELEMENTI (DALLA MENSOLA CON O SENZA BARATTOLI, AL PORTAROTOLO FINO AL PORTA IPAD), CHE PERMETTONO DI PERSONALIZZARLA A SECONDA DELLE PROPRIE ESIGENZE.

THIS COMPOSITION ALSO INCLUDES A SET OF ACCESSORIES AS PART OF THE UNDERCABINET HANGING RAIL: ELLE SYSTEM. THIS LINE FEATURES VARIOUS COMPONENTS (FROM THE SHELVES WITH OR WITHOUT JARS TO THE KITCHEN ROLL HOLDER AND IPAD HOLDER) WHICH CAN BE CUSTOMISED TO MEET CLIENT NEEDS.



LE COLONNE SI PRESENTANO
 COME UN UNICO BLOCCO, IL CUI
 SEGNO È DEFINITO DAI RILIEVI E
 FINITURE DELLE ANTE SCORREVOLI.
 ALL'INTERNO SCOMPARTI, RIPIANI,
 CASSETTI, CESTELLI, FORNI E TUTTO
 QUELLO CHE PUÒ SERVIRE AD UN
 COMODO UTILIZZO DELLA CUCINA.

THE COLUMN UNITS ARE ORGANISED
 AS A SINGLE BLOCK, VISUALLY
 SEPARATED FROM THE REST BY THE
 DETAILS IN RELIEF AND THE FINISHING
 TOUCHES ON THE SLIDING DOORS.
 INSIDE, THERE IS A HUGE RANGE OF
 COMPARTMENTS, RACKS, SHELVING,
 DRAWERS, BASKETS, OVENS AND
 ALL THAT IS REQUIRED TO MAKE A
 KITCHEN WHAT IT SHOULD BE.

creativa 04 melaminico effetto malta + laccato

ANTE / DOORS



MALTA GRIGIO NEBBIA +
GRIGIO PERLA LUCIDO
GREY FOG MORTAR +
GLOSSY PEARL GREY

TOP / WORKTOP



FENIX FUMO
SMOKE FENIX



LAMINATO STRATIFICATO RESINA
CUORE NERO FINITURA CLIMB FOLDING
LAYERED RESIN LAMINATE
BLACK HEART CLIMB FOLDING FINISH

ZOCCOLO / PLINTH



IN PVC LACCATO FUMO OPACO
PVC PLINTHS LACQUERED MATT SMOKE

LIBRERIA / BOOKSCASE



LACCATO GRIGIO FUMO
LACQUERED SMOKE GREY

SGABELLI / STOOL - VENERE



STRUTTURA GRIGIO NEBBIA
SEDUTA GRIGIO BROMO
SMOKE GREY BASE
BROMINE GREY SEAT

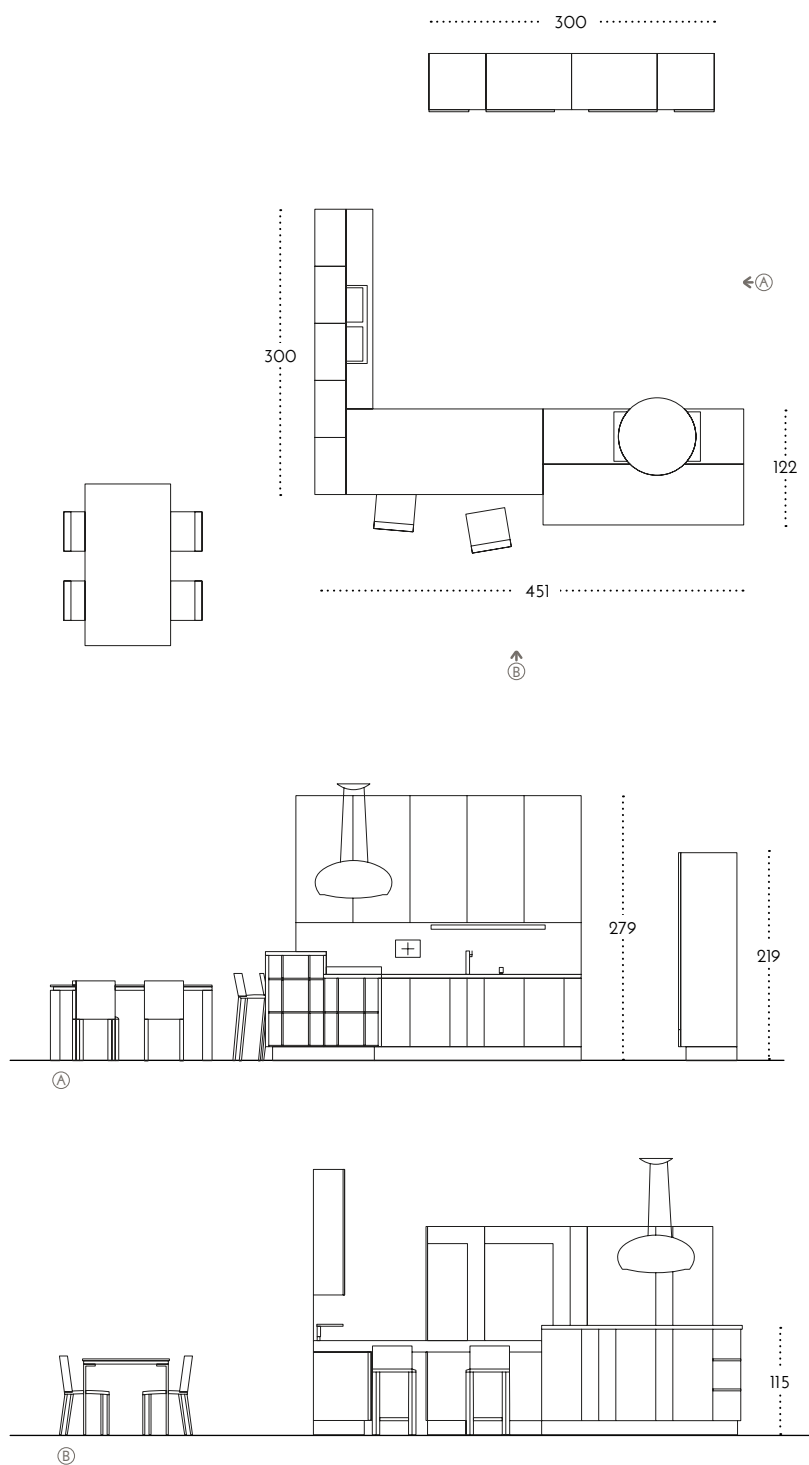







LE COLONNE VENGONO IMPIEGATE, OLTRE CHE PER IL CONTENIMENTO, COME FILTRO DI SEPARAZIONE TRA LA CUCINA E LA ZONA PRANZO.
IL BLOCCO SOSPESO DELL'AREA FUOCHI, LIBERATO DALLA PRESENZA DELLO ZOCCOLO, AGEVOLA I MOVIMENTI E RENDE UNICO IL DISEGNO CREATO DALLA COMPOSIZIONE.

APART FROM THEIR STORAGE CAPACITY, THE COLUMN UNITS ALSO SERVE AS A PARTITION WALL BETWEEN THE KITCHEN AND THE EATING AREA.
WITHOUT A PLINTH TO WEIGH IT DOWN, THE HANGING STOVE UNIT IS SUSPENDED FREELY FROM ABOVE, CREATING A HIGHLY ATTRACTIVE DESIGN EFFECT AND ENABLING GREAT EASE OF MOVEMENT.



L'AMPIA LIBRERIA A PARETE, IN LACCATO VERDE LICHENE E GRIGIO BROMO, SI RACCORDA ALLO STILE DELLE ANTE DI CREATIVA GRAZIE ALLA PRESENZA DEI PIENI E DEI VUOTI, DATI DALLE ANTE E DAGLI ELEMENTI A GIORNO, CHE DISEGNANO MOTIVI GEOMETRICI SENZA SACRIFICARE LO SPAZIO DI CONTENIMENTO.

THE EXTENSIVE BOOKSHELVES IN LACQUERED MOSS GREEN AND BROMINE GREY BLEND IN WITH THE STYLE OF THE CREATIVE CABINET DOORS, DUE TO THE ALTERNATION OF GAPS FORMED BY THE CABINET DOORS AND OPEN SHELVING WHICH ADD DIMENSION AND DEPTH WITHOUT SACRIFICING STORAGE SPACE.



ANTE BASI SOSPESE /
LACCATO OPACO GRIGIO BROMO+
LACCATO LUCIDO GRIGIO BROMO

TOP BASI SOSPESE /
LACCATO OPACO GRIGIO BROMO

LIBRERIA /
LACCATO OPACO GRIGIO BROMO

SCHIENALI LIBRERIA /
LACCATO VERDE LICHENE OPACO

HANGING BASE UNIT CABINETS /
MATT LACQUERED BROMINE GREY +
GLOSSY LACQUERED BROMINE GREY

HANGING BASE UNIT TOP /
MATT LACQUERED BROMINE GREY

BOOKSCASE /
MATT LACQUERED BROMINE GREY

BOOKCASE BACK /
MATT LACQUERED LICHEN GREEN

ANTE / DOORS



GRIGIO BROMO OPACO +
GRIGIO BROMO LUCIDO
MATT BROMINE GREY +
GLOSSY BROMINE GREY



VETRO SATINATO GRIGIO BROMO
SATIN GLASS BROMINE GREY

TOP / WORKTOP



FENIX GRIGIO BROMO
BROMINE GREY FENIX

ZOCCOLO / PLINTH



IN PVC LACCATO GRIGIO BROMO OPACO
PVC PLINTHS LACQUERED MATT BROMINE GREY

LIBRERIA / BOOKSCASE



LACCATO VERDE LICHENE OPACO
MATT LACQUERED LICHEN GREEN

TAVOLO / TABLE - INCLINE



PIANA IN LAMINATO FENIX GRIGIO BROMO
STRUTTURA IN FERRO GREZZO
BROMINE GREY FENIX LAMINATE TOP
ROUGH IRON BASE

SEDIE E SGABELLI / CHAIRS AND STOOLS - ISIG



SEDUTA BIANCO,
STRUTTURA FAGGIO TINTO NATURALE
WHITE SEAT,
FRAME IN NATURAL DYED BEECH

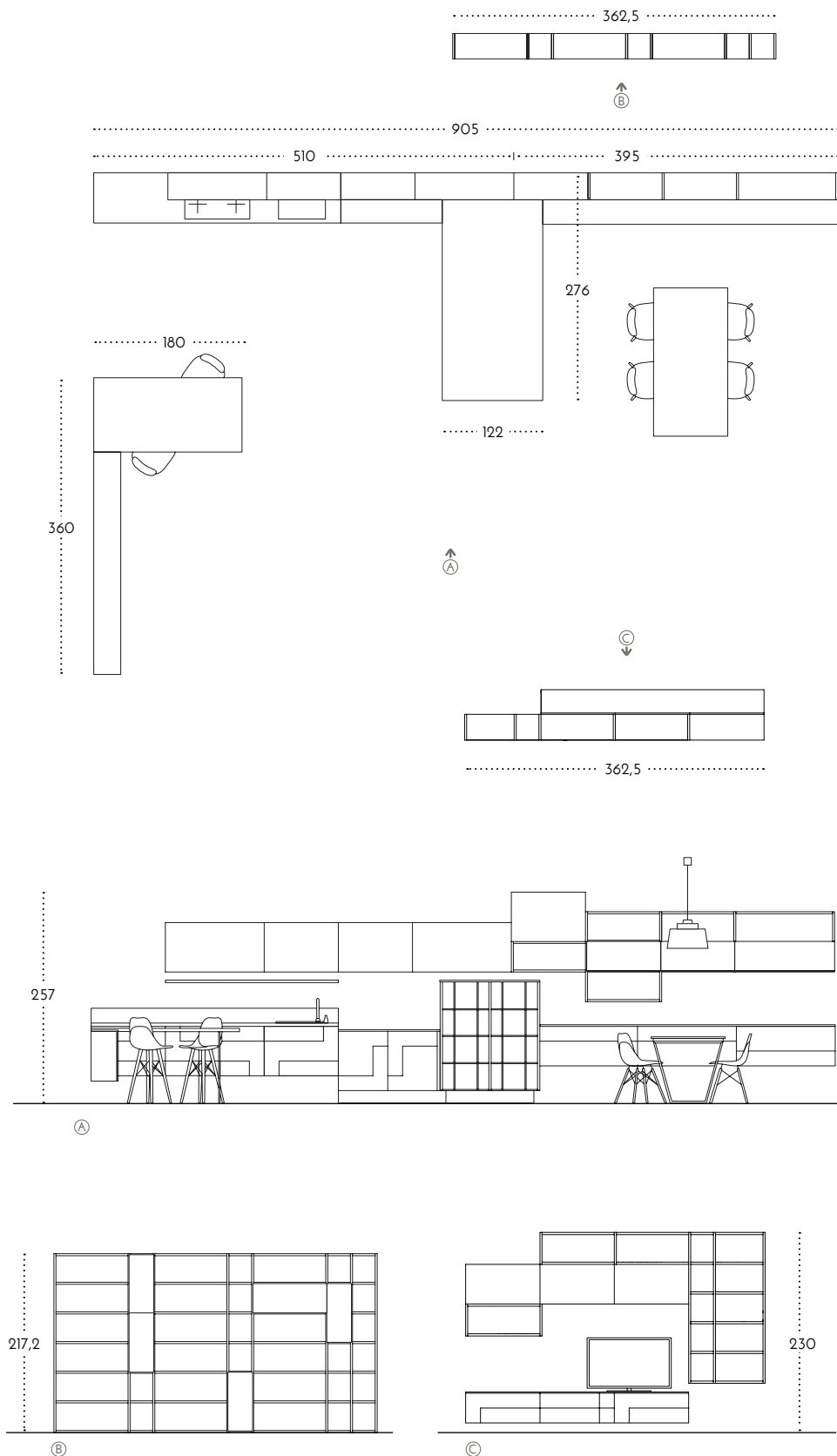







LE GEOMETRIA, MAI BANALE, DELLE ANTE DI CREATIVA PERMETTE DI AVERE SEMPRE UN MOTIVO DECORATIVO PROTAGONISTA DELLA COMPOSIZIONE ANCHE QUANDO, COME IN QUESTO CASO, LE FINITURE PRINCIPALI SONO TONO SU TONO (BIANCO CALDO OPACO E BIANCO LUCIDO).

THE DESIGN OF CREATIVA'S CABINET DOORS NEVER PALLS AND HAS BEEN CONCEIVED SO THAT EVEN IF A TONAL FINISHING COMBINATION IS CHOSEN (WARM MATT WHITE AND GLOSSY WHITE) THE DECORATIVE BEAUTY STILL STANDS OUT.



ANTE BASI SOSPESSE /
LACCATO BIANCO ASSOLUTO OPACO +
LACCATO BIANCO ASSOLUTO LUCIDO

SPALLE E ANTE LIBRERIA /
BIANCO OPACO

SCHIENALI LIBRERIA /
LACCATO ROSSO TOSCANO OPACO

HANGING BASE UNIT CABINETS /
MATT LACQUERED ABSOLUTE WHITE +
GLOSSY LACQUERED ABSOLUTE WHITE

BACK PANEL AND CABINET DOORS OF
BOOKSCASE /
MATT WHITE

BOOKSCASE BACK /
MATT LACQUERED TOSCAN RED

ANTE / DOORS



BIANCO ASSOLUTO OPACO +
BIANCO ASSOLUTO LUCIDO
MATT ABSOLUTE WHITE +
GLOSSY ABSOLUTE WHITE



VETRO FUMO SATINATO
SATIN GLASS SMOKE

TOP / WORKTOP



LAB LUBE FUMO
LAB LUBE SMOKE



LAMINATO ROVERE MENPHIS FINITURA ALEVÈ
MEMPHIS OAK LAMINATED ALEVÈ FINISH

ZOCCOLO / PLINTH



IN PVC LACCATO BIANCO CALDO OPACO
PVC PLINTHS LACQUERED MATT WARM WHITE



IN PVC LACCATO FUMO OPACO
PVC PLINTHS LACQUERED MATT SMOKE

LIBRERIA / BOOKSCASE



LACCATO FUMO OPACO
MATT LACQUERED SMOKE

SGABELLI / STOOL - AVAND



LACCATO BIANCO
LACQUERED WHITE

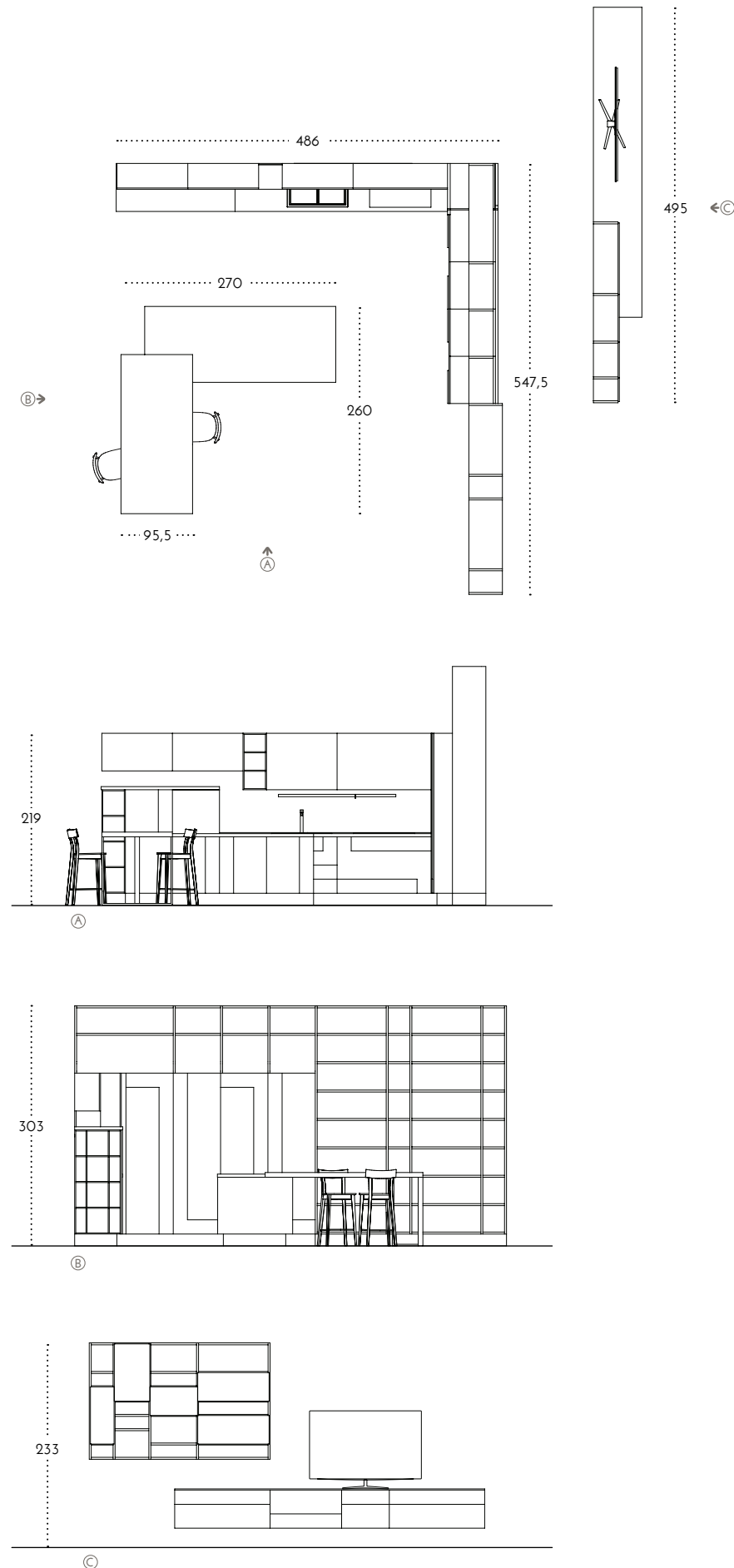







I CONTRASTI FORTI E DECISI, DATI DALL'UTILIZZO DEL ROVERE BROWN ABBINATO AL LACCATO BIANCO CALDO LUCIDO, SONO I PROTAGONISTI DELLA COMPOSIZIONE QUI PRESENTATA. IL LIVING VIENE INVECE CARATTERIZZATO DALLA PRESENZA DELLE ANTE IN MALTA PETTINATA DIPINTE A MANO. VERI E PROPRI PEZZI UNICI A METÀ STRADA TRA ARTE E DESIGN.

THE RICH BOLD CONTRASTS CREATED BY A COMBINATION OF BROWN OAK AND GLOSSY LACQUERED WARM WHITE GIVE A STUNNING RESULT. ON THE OTHER HAND, THE LIVING AREA FEATURES HAND-PAINTED COMBED MORTAR DOORS. ONE-OF-A-KIND ITEMS WHICH ARE HALFWAY BETWEEN ART AND DESIGN.

ANTE / DOORS



ROVERE BROWN +
BIANCO CALDO LUCIDO
BROWN OAK +
GLOSSY WARM WHITE



LACCATO BIANCO CALDO LUCIDO
GLOSSY LACQUERED WARM WHITE

TOP / WORKTOP



LIGHT BROWN
LIGHT BROWN

ZOCCOLO / PLINTH



PVC LACCATO BIANCO CALDO
PVC LACQUERED WARM WHITE

LIBRERIA / BOOKSCASE

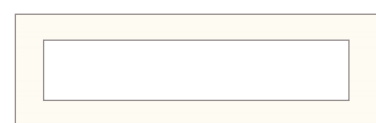

MELAMINICO BIANCO CALDO
MELAMINE WARM WHITE

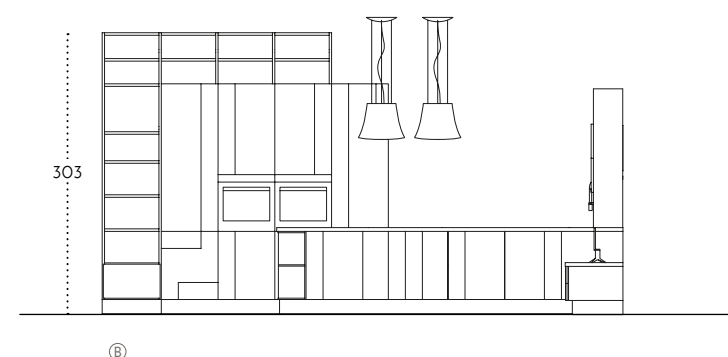
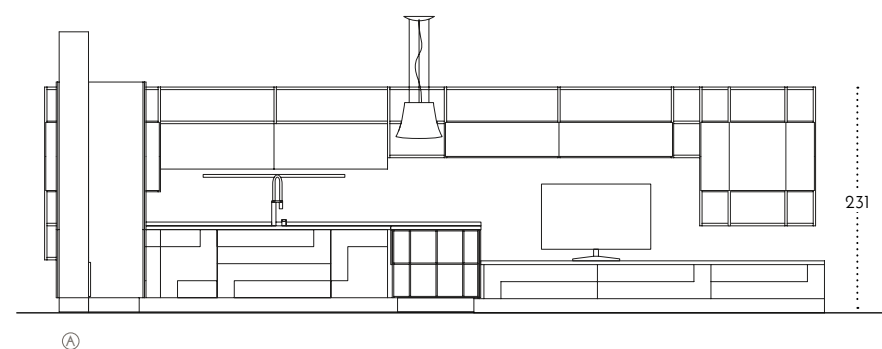
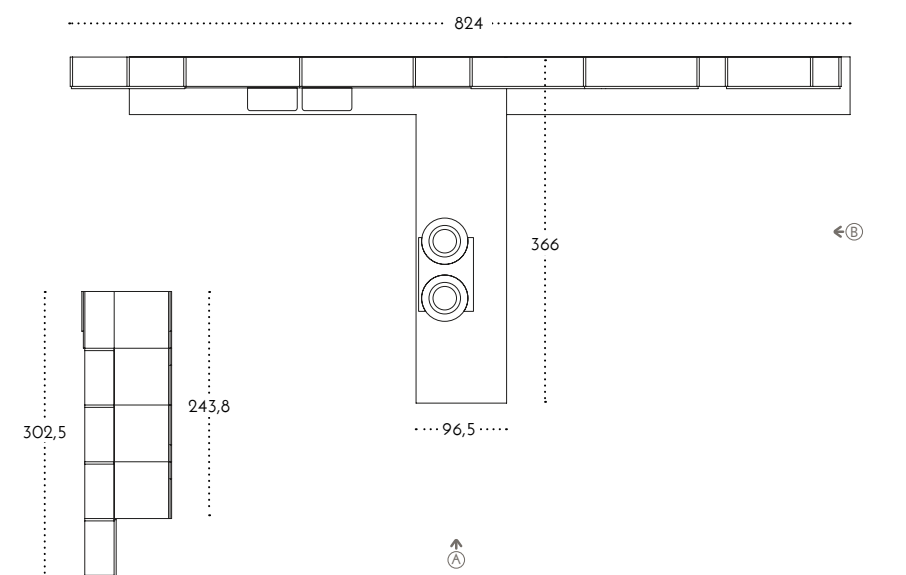

creativa®

FINITURE E COLORI

FINISHES AND COLOURS

UNA AMPIA GAMMA DI COLORI DI TENDENZA E FINITURE INNOVATIVE ARRICCHISCONO E COMPLETANO IL PROGRAMMA PER CONSENTIRE LA MASSIMA PERSONALIZZAZIONE DI OGNI AMBIENTE.

A WIDE RANGE OF TREND COLOURS AND INNOVATIVE FINISHES ENRICHES AND COMPLETES THE PROGRAMME ENSURING MAXIMUM CUSTOMISATION FOR EACH SETTING.



ANTE PENSILI - SOLO PRESA MANIGLIA SUL FONDO

SP. 16MM

WALL UNITS DOORS - ONLY HANDLE GRIP ON BOTTOM

TH. 16MM

MELAMINICO ROVERE

MELAMINE OAK



ROVERE BROWN (OPZ.5320)

BROWN OAK

ANTE BASI - COLONNE CON MANIGLIA INTEGRATA

SP. 32MM

BASE UNIT - COLUMN DOORS

TH. 32MM

melaminico rovere
+ laccato

È POSSIBILE ABBINARE AD OGNI MELAMINICO
UN QUALSIASI COLORE LACCATO

EVERY MELAMINIC FINISH CAN BE MATCHED
WITH EVERY LACQUERED COLOUR



ROVERE BROWN + BIANCO CALDO OPACO (OPZ.7401)
ROVERE BROWN + BIANCO CALDO LUCIDO (OPZ.7402)

BROWN OAK + MATT WARM WHITE
BROWN OAK + GLOSSY WARM WHITE

ANTE PENSILI - SOLO PRESA MANIGLIA SUL FONDO

WALL UNITS DOORS - ONLY HANDLE GRIP ON BOTTOM

SP. 16MM

TH. 16MM

MELAMINICO EFFETTO MALTA

MELAMINE MORTAR EFFECT



GRIGIO NEBBIA (OPZ.9626)
FOG GREY



JUTA (OPZ.8863)
JUTE



LAVAGNA (OPZ.9627)
SLATE GREY

ANTE PENSILI - SOLO PRESA MANIGLIA SUL FONDO

WALL UNITS DOORS - ONLY HANDLE GRIP ON BOTTOM

SP. 16MM

TH. 16MM

LACCATO

LACQUERED

PER TUTTA LA GAMMA DI COLORI
VEDI LE PAGINE 100-101

THIS APPLIES TO THE ENTIRE COLOUR RANGE
SEE PAGES 100-101

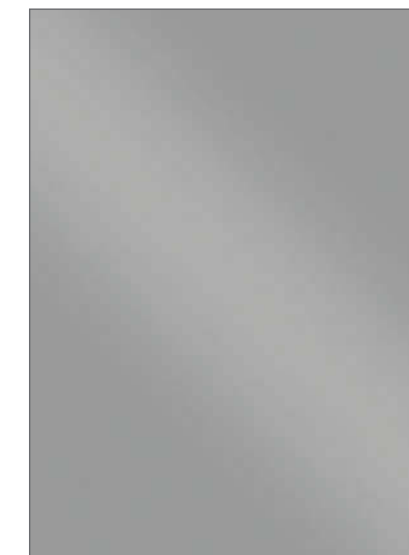

ANTE BASI - COLONNE CON MANIGLIA INTEGRATA

BASE UNIT - COLUMN DOORS

SP. 32MM

TH. 32MM

melaminico effetto malta + laccato

melamine mortar effect + lacquered

È POSSIBILE ABBINARE AD OGNI MELAMINICO
UN QUALSIASI COLORE LACCATO

EVERY MELAMINIC FINISH CAN BE MATCHED
WITH EVERY LACQUERED COLOUR

ANTE BASI - COLONNE CON MANIGLIA INTEGRATA

BASE UNIT - COLUMN DOORS

SP. 32MM

TH. 32MM

laccato + laccato

lacquered + lacquered

I COLORI RAPPRESENTATI SONO
PURAMENTE INDICATIVI

THE COLOURS SHOWN ARE
MERELY INDICATIVE

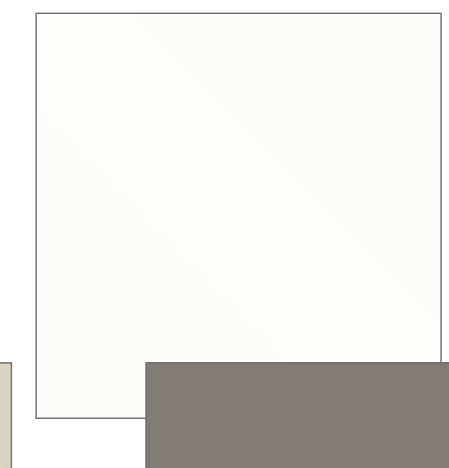
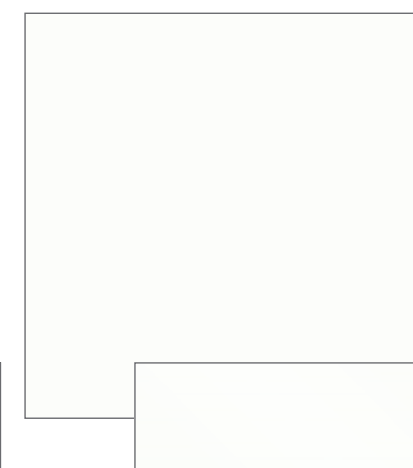
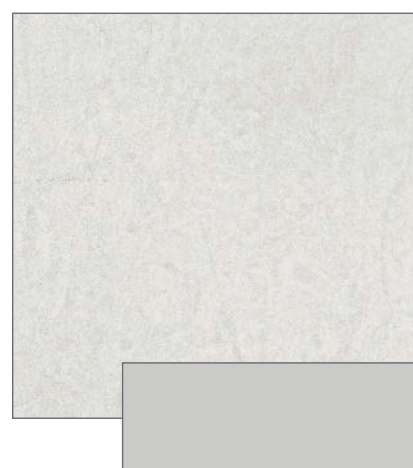

COLORI TESTURIZZATI SOFT

SOFT TEXTURED COLOURS

 [CLICCA QUI PER LA GAMMA COLORI DISPONIBILI](#)

 [CLICK HERE FOR THE RANGE OF AVAILABLE COLORS](#)

 [ZUR FARBAUSWAHL HIER KLICKEN](#)

LACCATO LUCIDO DIRETTO

GLOSSY LACQUERED

 [CLICCA QUI PER LA GAMMA COLORI DISPONIBILI](#)

 [CLICK HERE FOR THE RANGE OF AVAILABLE COLORS](#)

 [ZUR FARBAUSWAHL HIER KLICKEN](#)

COLORI VETRI SATINATI

SATIN GLASS COLOURS

SOLO PER ANTE PENSILI

FOR WALL UNIT DOORS ONLY

 <p>BIANCO ASSOLUTO ABSOLUTE WHITE (OPZ.V740S)</p>	 <p>BIANCO CALDO WARM WHITE (OPZ.V740I)</p>	 <p>CANAPA HEMP (OPZ.V853I)</p>	 <p>CENERE ASH (OPZ.V9547)</p>	 <p>GRIGIO BROMO BROMINE GREY (OPZ.V9533)</p>	 <p>LAVAGNA SLATE GREY (OPZ.V9543)</p>	 <p>NERO BLACK (OPZ.V7892)</p>
 <p>CASTORO BEAVER (OPZ.V8907)</p>	 <p>FUMO SMOKE (OPZ.V953I)</p>	 <p>GRIGIO PIOMBO LEAD GREY (OPZ.V9537)</p>	 <p>BISTROT BISTROT (OPZ.V9535)</p>	 <p>VERDE LICHENE LICHEN GREEN (OPZ.V8463)</p>	 <p>VERDE POSITANO POSITAN GREEN (OPZ.V847I)</p>	 <p>GIALLO AMBRA AMBER YELLOW (OPZ.V327S)</p>
 <p>ROSSO TOSCANO TUSCAN RED (OPZ.V8157)</p>	 <p>BRONZO BRONZE (OPZ.V8903)</p>					

COLORI VETRI LUCIDI

GLOSSY GLASS COLOURS

SOLO PER ANTE PENSILI

FOR WALL UNIT DOORS ONLY

		 <p>CANAPA HEMP (OPZ.V8532)</p>	 <p>CENERE ASH (OPZ.V9548)</p>	 <p>GRIGIO BROMO BROMINE GREY (OPZ.V9534)</p>	 <p>LAVAGNA SLATE GREY (OPZ.V9544)</p>	 <p>NERO BLACK (OPZ.V7893)</p>
 <p>CASTORO BEAVER (OPZ.V8908)</p>	 <p>FUMO SMOKE (OPZ.V9532)</p>	 <p>GRIGIO PIOMBO LEAD GREY (OPZ.V9538)</p>	 <p>BISTROT BISTROT (OPZ.V9536)</p>	 <p>VERDE LICHENE LICHEN GREEN (OPZ.V8464)</p>	 <p>VERDE POSITANO POSITAN GREEN (OPZ.V8472)</p>	 <p>GIALLO AMBRA AMBER YELLOW (OPZ.V328)</p>
 <p>ROSSO TOSCANO TUSCAN RED (OPZ.V8158)</p>	 <p>BRONZO BRONZE (OPZ.V8904)</p>					

ANTE PENSILI

WALL UNITS DOORS

SP. 16MM

TH. 16MM

ANTA IN MDF LAVORATA CON MALTA NATURALE A BASE DI CALCE SOLO PER ANTE PENSILI

MDF DOOR WORKED WITH NATURAL LIME-BASED

MORTAR PORTE EN MDF TRAVAILLÉE ONLY FOR WALL UNITS DOORS



EFFETTO MATERICO
TINTO VISONE (OPZ. 946SM)
MINK DYED TEXTURED EFFECT



EFFETTO MATERICO
TINTO GRIGIO PERLA (OPZ. 9555M)
PEARL GREY DYED TEXTURED EFFECT



EFFETTO MATERICO
TINTO LAVAGNA (OPZ. 9543M)
SLATE GREY DYED TEXTURED EFFECT

ZOCCOLI

PLINTH

ZOCCOLI IN PVC H 15

PVC PLINTHS H 15



ACCIAIO (OPZ. 407)
STEEL



ALLUMINIO SATINATO (OPZ. 405)
SATIN ALUMINIUM

ZOCCOLI IN ALLUMINIO H 15

ALUMINIUM PLINTHS H 15



ALLUMINIO LISCIO
FINITURA BRILL (OPZ. 412)
ALUMINIUM
SMOOTH WITH BRILL FINISH



ALLUMINIO FINITURA TITANIO
OSSIDATO (OPZ. 414)
ALUMINIUM TITANIUM
OXIDIZED FINISH

ZOCCOLI IN PVC LACCATI OPACHI E LUCIDI H 15

PVC PLINTHS LACQUERED MATT AND GLOSSY H 15



VISONE OPACO / LUCIDO
MATT / GLOSSY MINK



GRIGIO PERLA OPACO / LUCIDO
MATT / GLOSSY PEARL GREY



LAVAGNA OPACO / LUCIDO
MATT / GLOSSY SLATE GREY

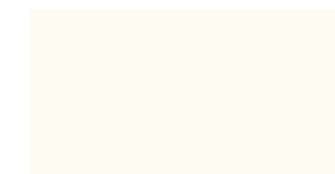

BIANCO CALDO OPACO / LUCIDO
MATT / GLOSSY WARM WHITE



TITANIO OPACO / LUCIDO
MATT / GLOSSY TITANIUM

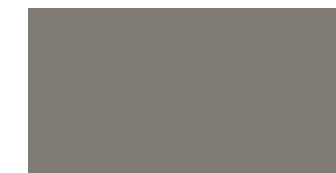

FUMO OPACO / LUCIDO
MATT / GLOSSY SMOKE



GRIGIO BROMO OPACO / LUCIDO
MATT / GLOSSY BROMINE GREY

PROGETTO E COORDINAMENTO:
ING. ALESSIO SILEONI
UFFICIO R&S: CARLO SACCHI, ARCH. EURO MARINUCCI
UFFICIO MKT: NADIA DEL PUPO
"LUBE SERVICE & ENGINEERING S.R.L."

ART DIRECTION, PROGETTO E GRAFICA: STUDIO FERRIANI
DIGITAL PHOTOGRAPHY: STUDIO FERRIANI

SELEZIONI : Z13
STAMPA: LA PIEVE POLIGRAFICA EDITORE, VILLA VERUCCHIO S.R.L.

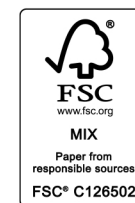

LA LUBE INDUSTRIES SRL SI RISERVA LA FACOLTA' DI APPORTARE IN OGNI MOMENTO E SENZA PREAVVISO QUALSIASI MODIFICA TECNICA E CROMATICA RITENUTE UTILI AL MIGLIORAMENTO DEI PROPRI PRODOTTI.
I CAMPIONI E I COLORI RIPRODOTTI SONO PURAMENTE INDICATIVI.
LA RAPPRESENTAZIONE IN STAMPA PUO' ALTERARE LE TONALITA' DEI COLORI.

LUBE INDUSTRIES SRL RESERVES THE RIGHT TO MAKE AT ANY TIME AND WITHOUT PRIOR NOTICE ANY TECHNICAL AND COLOUR MODIFICATION DEEMED USEFUL FOR THE IMPROVEMENT OF ITS PRODUCTS.
THE SHOWN SAMPLES AND COLOURS ARE PURELY INDICATIVE.
PRINTED REPRESENTATION MAY ALTER THE ACTUAL COLOUR TONES.