

OLTRE



FINITURE MATERICHE TEXTURED FINISHES

Rigorosa nella sua linearità ma ricca nella sua essenza Oltre presenta, finiture particolari ed accessori che la rendono assolutamente unica nel suo genere. I colori ed i materiali sono tanti e studiati per essere abbinati elegantemente insieme, raffinati e pregiati come le ante realizzate con malta stesa a mano, con effetto cemento, oppure in legno impiallacciato dalla forte tattilità. Caratterizzata dalla meticolosa cura del dettaglio e da un'ampia modularità, Oltre diventa protagonista anche nello spazio living e dining con esclusive soluzioni arredative di design.

Oltre offers rigorous lines and a rich essence, with many different finishes, details and accessories that make it unique in its genre. There are many colours and materials available, all designed to blend together elegantly to create a refined and exclusive look, such as doors with cement-effect hand-applied mortar and those with highly tactile wood veneer. Characterised by a meticulous attention to detail and a high level of modularity, Oltre is also a star of the living room and dining area, offering exclusive designer furnishing solutions.

L'ANTA QUADRATA SI ABBINA ALLA GOLA AD "ELLE" PER CREARE LA COLLEZIONE NECK. UN' ANTA PRESENTATA IN UN' AMPIA GAMMA DI COLORI E FINITURE CHE POSSONO PERSONALIZZARE LA GOLA.

THE SQUARE DOOR MATCHES WITH THE "L" FINGER RAIL OPENING TO CREATE THE NECK COLLECTION.

THE DOOR IS PRESENTED ON A WIDE RANGE OF COLOURS AND FINISHES THAT CAN CUSTOMIZE THE FINGER RAIL OPENING.

OLTRE

Neck

ANTA QUADRATA
CON MANIGLIA A GOLA
SQUARE DOOR WITH FINGER
RAIL OPENING



L'ERGONOMIA DELLA FORMA DELL'ANTA CARATTERIZZA LA COLLEZIONE LUX. L'ANTA CON PROFILO INCLINATO IN CORRISPONDENZA DELLA GOLA, OFFRE UNA PRESA ED UN'APERTURA MIGLIORI. L'ANTA PUO' ESSERE DOTATA DI UN PROFILO DI PROTEZIONE COORDINATO ALLE FINITURE E COLORI DELLA GOLA.

THE LUX COLLECTION IS CHARACTERIZED BY THE DOORS ERGONOMIC FORM. THE DOOR WITH AN INCLINED PROFILE NEAR THE FINGER RAIL OPENING SYSTEM, OFFERS THE BEST POSSIBLE GRIP AND OPENING. THE DOOR MAY BE EQUIPPED WITH A PROTECTION PROFILE COORDINATED WITH THE FINGER RAIL OPENING SYSTEM FINISHES AND COLOURS.

OLTRE

LUX

ANTA INCLINATA
CON MANIGLIA A GOLA
INCLINED DOOR WITH FINGER
RAIL OPENING



APERTURA CON GOLLA OPENING BY FINGER RAIL

Neck

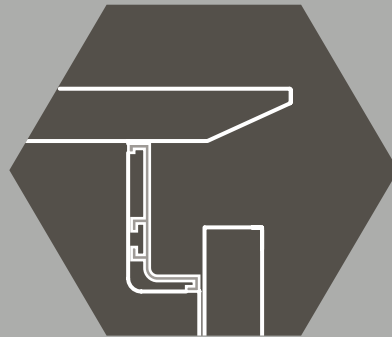

GOLA TIPO "ELLE"
"ELLE" TYPE FINGER RAIL

ANTA SQUADRATA
DOOR SQUARED

LUX

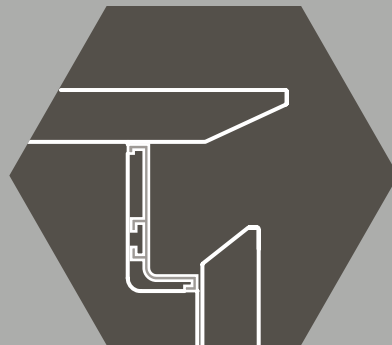

GOLA TIPO "ELLE"
"ELLE" TYPE FINGER RAIL

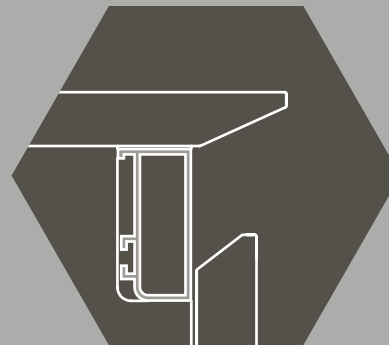

GOLA PIATTA
FLAT FINGER RAIL

ANTA INCLINATA
SENZA PROFILO
INCLINED EDGE DOOR
WITHOUT PROFILE

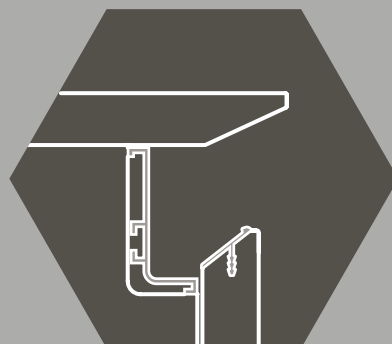

GOLA TIPO "ELLE"
"ELLE" TYPE FINGER RAIL

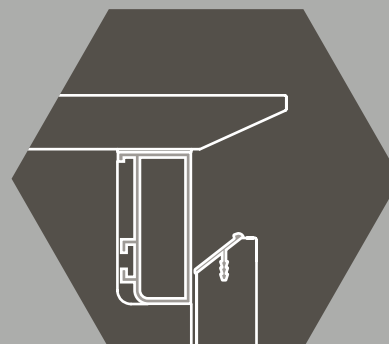

GOLA PIATTA
FLAT FINGER RAIL

ANTA INCLINATA
CON PROFILO
ALLUMINIO
(OPZ. PI + COD. COLORE)
INCLINED EDGE DOOR
WITH ALUMINIUM PROFILE



FINITURE GOLE SPAZZOLATE DISPONIBILI SOLO PER GOLA TIPO "ELLE"
 MATT FINGER RAILS BRUSHED FINISHES, AVAILABLE ONLY FOR "ELLE" TYPE FINGER RAIL



FINITURE GOLE E PROFILO SPAZZOLATI
 FINGER RAILS AND PROFILE BRUSHED FINISHES



N.B.: ABBINAMENTO CONSIGLIATO
 CON L'ANTA BRONZO BRUNITO
 NOTE: BEST MATCHING WITH THE
 BURNISHED BRONZE DOOR









* opz. 412 brill non disponibile per profili

FINITURE GOLE E PROFILO VERNICIATI A POLVERE OPACHI
 MATT FINGER RAILS AND PROFILE POWDER COATED FINISHES

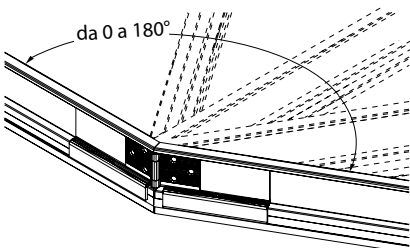

GOLA "ELLE" ORIZZONTALE SOTTOTOP

UNDERMOUNT HORIZONTAL "ELLE" FINGER RAIL





	COD.			COD.		
<p>Gola sottotop tipo "A" Type "A" undermount finger rail</p>  <p style="text-align: right;">al ml per lm</p>	G950010			<p>Angolo interno a 90° per gola tipo "A" 90° interior corner for "A" type finger rail</p>  <p style="text-align: right;">cadauno each</p>	G950050	
<p>Terminale aperto dx o sx per gola tipo "A" da utilizzare a fine composizione RH or LH open end for type "A" finger rail to be placed at the end of the composition</p>  <p style="text-align: right;">terminale DX RH end terminale SX LH end</p>	G950021			<p>Angolare con snodo per unione fuori squadra per gola tipo "A" Corner piece with joint for out-of-plumb joining for type "A" finger rail</p> 		
<p>Terminale chiuso dx o sx per gola tipo "A" da utilizzare solo tra basi e colonne RH or LH closure for type "A" finger rail to be placed only between base units and column</p>  <p style="text-align: right;">terminale DX RH end terminale SX LH end</p>	G950022					
<p>Terminale chiuso dx o sx per gola tipo "A" da utilizzare solo tra basi e colonne RH or LH closure for type "A" finger rail to be placed only between base units and column</p>  <p style="text-align: right;">terminale DX RH end terminale SX LH end</p>	G950031			 <p style="text-align: center;">da 0 a 180°</p>	G950060	
<p>Terminale chiuso dx o sx per gola tipo "A" da utilizzare solo tra basi e colonne RH or LH closure for type "A" finger rail to be placed only between base units and column</p>  <p style="text-align: right;">terminale DX RH end terminale SX LH end</p>	G950032					
<p>Coppia angolari per kit raccordo base angolo 110x110 Couple corner piece for fitting kit corner base unit 110x110</p>  <p style="text-align: center;">SX LH DX RH</p> <p style="text-align: right;">in alluminio aluminium angolare DX RH corner piece angolare SX LH corner piece</p>	G950058					
	G950059					





GOLA "ELLE" ORIZZONTALE INTERMEDIA

INTERMEDIATE HORIZONTAL "ELLE" FINGER RAIL

GOLE "ELLE" VERTICALI PER COLONNE

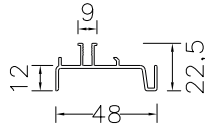
VERTICAL "ELLE" FINGER RAILS FOR COLUMNS

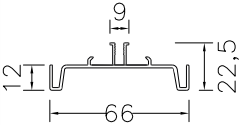
	COD.	
<p>Gola intermedia tipo "B" Type "B" intermediate finger rail</p>  <p style="text-align: right;">al ml per lm</p>	G950110	
<p>Terminale aperto dx o sx per gola tipo "B" da utilizzare a fine composizione RH or LH open end for type "B" finger rail to be placed at the end of the composition</p>  <p style="text-align: right;">terminale DX RH end terminale SX LH end</p>	G950121 G950122	
<p>Terminale chiuso dx o sx per gola tipo "B" da utilizzare solo tra cassettiere e lavastoviglie/colonne RH or LH closure for type "B" finger rail to be placed only between drawer units and dishwasher/columns</p>  <p style="text-align: right;">terminale DX RH end terminale SX LH end</p>	G950131 G950132	
<p>Angolo interno a 90° per gola tipo "B" 90° interior corner for "B" type finger rail</p>  <p style="text-align: right;">cadauno each</p>	G950150	

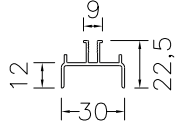
	COD.	
<p>Mezza gola verticale tipo "C" (completa di distanziale) Type "C" half vertical finger rail (complete with spacer)</p>   <p style="text-align: center;">sezione mezza gola tipo "C" cross section of type "C" finger rail</p> <p>Piedi H 13 H 96 H 132 H 204 H 228</p> <p>Piedi H 6 H 108 H 144 H 216</p>	G950310 G950330 G950350 G950370 G950320 G950340 G950360	
<p>Gola verticale intermedia tipo "D" (completa di distanziale) Type "D" intermediate vertical finger rail (complete with spacer)</p>   <p style="text-align: center;">sezione gola tipo "D" cross section of type "D" finger rail</p> <p>Piedi H 13 H 96 H 132 H 204 H 228</p> <p>Piedi H 6 H 108 H 144 H 216</p>	G950410 G950430 G950450 G950470 G950420 G950440 G950460	
<p>Gola verticale laterale tipo "E" (completa di distanziale) Type "E" lateral vertical finger rail (complete with spacer)</p>   <p style="text-align: center;">sezione gola tipo "E" cross section of type "E" finger rail</p> <p>Piedi H 13 H 96 H 132 H 204 H 228</p> <p>Piedi H 6 H 108 H 144 H 216</p>	G950510 G950530 G950550 G950570 G950520 G950540 G950560	

NOZIONI UTILI - gole "elle" orizzontali per basi

USEFUL INFORMATION - HORIZONTAL "ELLE" FINGER RAILS FOR BASE UNITS

VISTA FRONTALE ZOCCOLO H 6 PER BASI H 90

FRONT VIEW PLINTH H 6 FOR BASE UNITS H 90

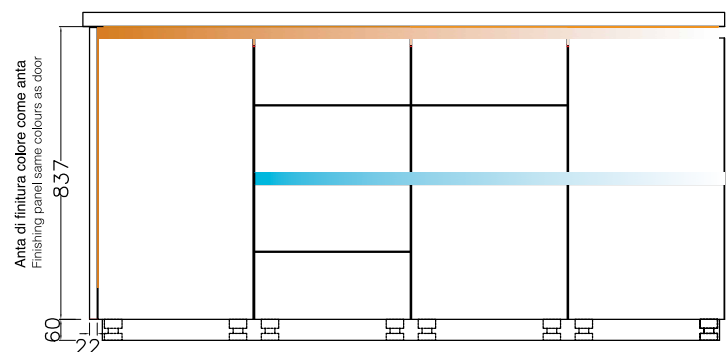
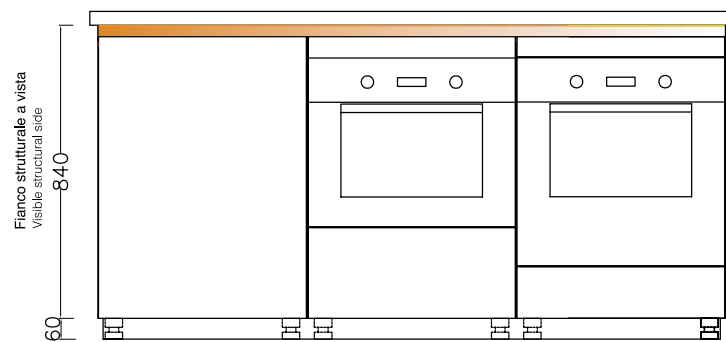

VISTA LATERALE (sezione) ZOCCOLO H 6 PER BASI H 90

SIDE VIEW (CROSS SECTION) PLINTH H 6 FOR BASE UNITS H 90

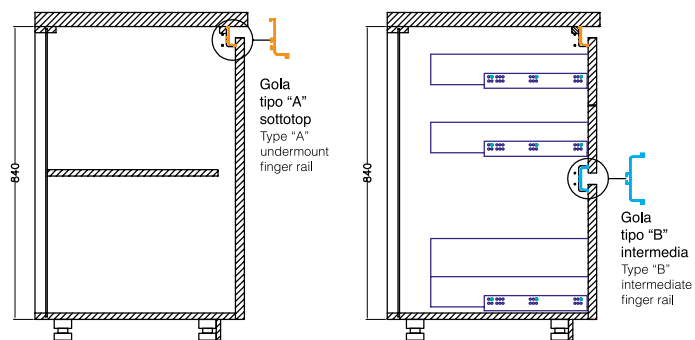

VISTA DALL'ALTO

TOP VIEW

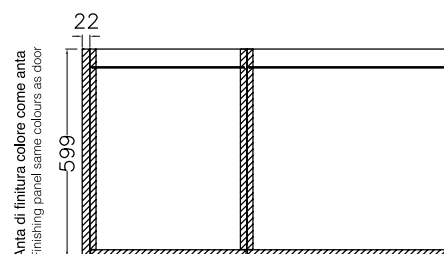
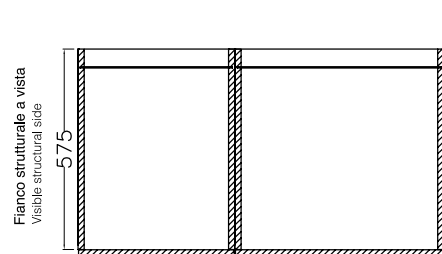

Composizione con ante di finitura laterali: alla dimensione finale della cucina, sommare sempre lo spessore delle ante di finitura (ogni anta 2,2 cm)

Composition with side finishing panels: to the final size of the kitchen, always add the thickness of the finishing panels (each panel 22 mm)

NOZIONI UTILI - gole "elle" verticali per colonne

USEFUL INFORMATION - VERTICAL "ELLE" FINGER RAILS FOR COLUMNS

VISTA FRONTALE ZOCCOLO H 6

FRONT VIEW PLINTH H 6

N.B.: per la versione Lux sulle colonne il profilo anta è sempre inclinato verticale

Note: door always with vertical inclined profile for the Lux versions' columns

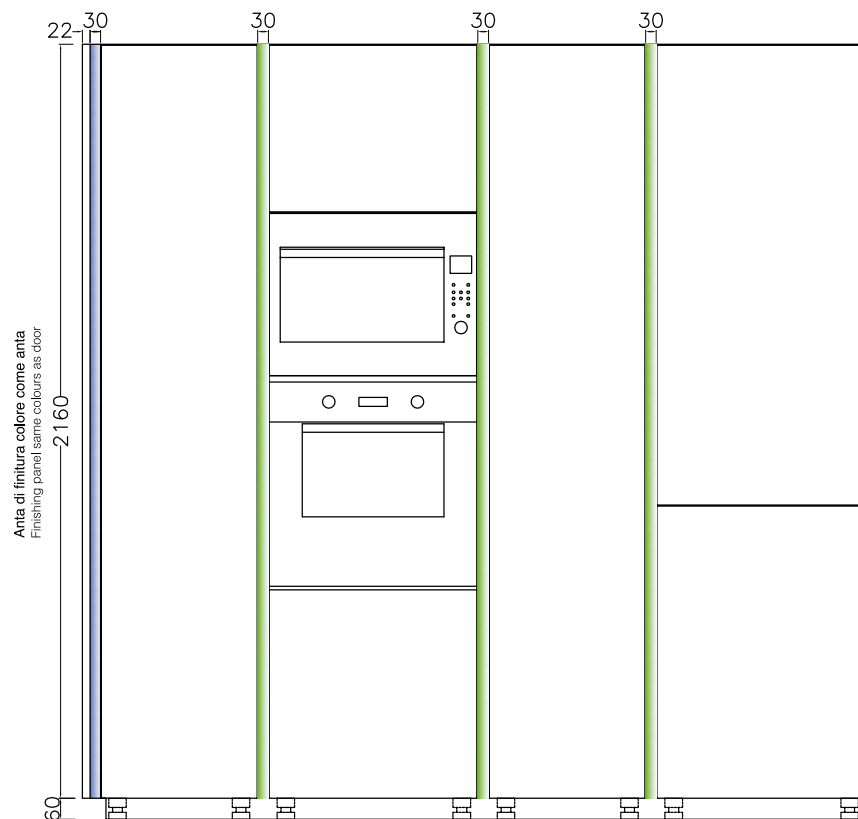

VISTA DALL'ALTO

TOP VIEW

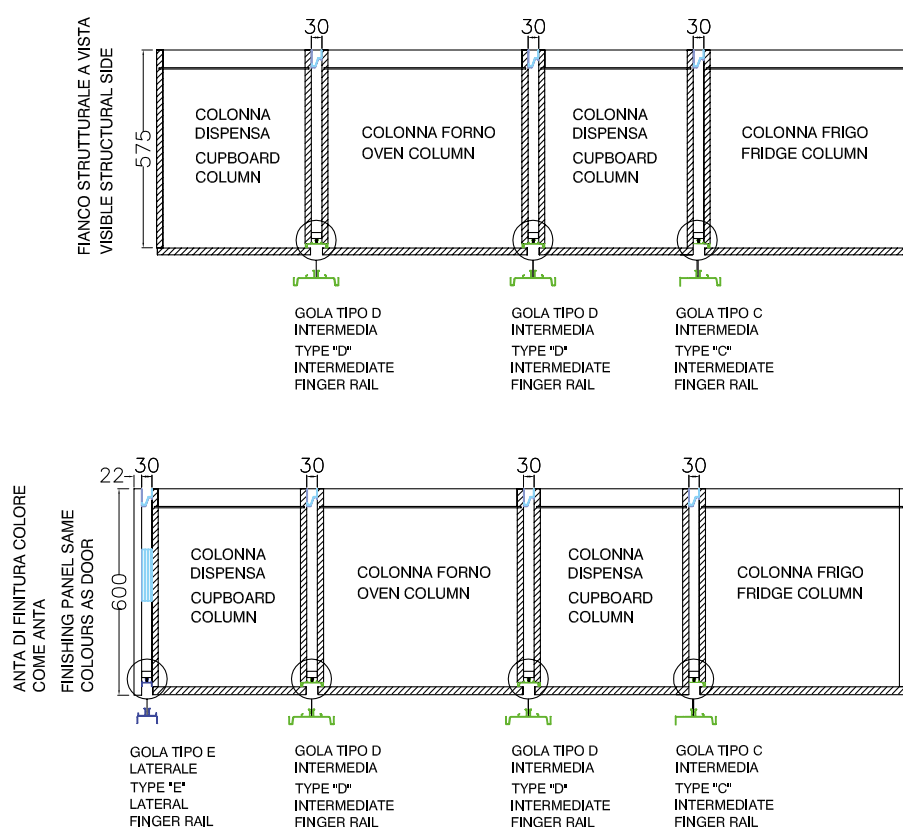

Composizione fianco strutturale a vista come anta:
alla dimensione finale della cucina, sommare sempre lo spessore dei distanziali tra le colonne (ogni distanziale 3 cm)





Composition with visible side panel to match door:
to the final size of the kitchen, always add the thickness of the spacers between the two columns (each spacer 3 cm)

Composizione con ante di finitura laterali, alla dimensione finale della cucina, sommare sempre lo spessore dei distanziali tra le colonne (ogni distanziale 3 cm) e lo spessore delle ante di finitura (ogni anta 2,2 cm)

Composition with side finishing panels to the final size of the kitchen, always add the thickness of the spacer between the two columns (each spacer 3 cm) and the thickness of the finishing panels (each panel 22 mm)

GOLA PIATTA ORIZZONTALE SOTTOTOP

UNDERMOUNT HORIZONTAL **FLAT** FINGER RAIL







	COD.			COD.		
<p>Gola piatta sottotop tipo "AP" Type "AP" undermount flat finger rail</p> 	G960010	al ml per lm		<p>Angolo interno a 90° per gola tipo "AP" 90° interior corner for "AP" type finger rail</p> 	G960050	cadauno each
<p>Terminale chiuso "T1" dx o sx per gola tipo "AP" da utilizzare a fine composizione "T1" RH or LH closure for type "AP" finger rail to be placed at the end of the composition</p> 	G960021	terminale DX RH end		<p>Angolare con snodo per unione fuori squadra per gola tipo "AP" Corner piece with joint for out-of-plumb joining for type "AP" finger rail</p> 	G950060	
	G960022	terminale SX LH end				
<p>Terminale chiuso "T2" dx o sx per gola tipo "AP" da utilizzare solo tra basi e colonne "T2" RH or LH closure for type "AP" finger rail to be placed only between base units and column</p> 	G960031	terminale DX RH end				
	G960032	terminale SX LH end				

GOLA PIATTA ORIZZONTALE INTERMEDIA

INTERMEDIATE HORIZONTAL FLAT FINGER RAIL

GOLE VERTICALI PIATTE PER COLONNE

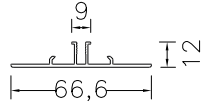
VERTICAL FLAT FINGER RAILS FOR COLUMNS

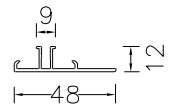
	COD.						
 <p>Gola piatta intermedia tipo "BP" Type "BP" intermediate flat finger rail</p>							
	<p>al ml per lm</p>	G960110					
 <p>Terminale chiuso "T3" dx o sx per gola tipo "BP" da utilizzare a fine composizione "T3" RH or LH closure for type "BP" finger rail to be placed at the end of the composition</p>							
	<p>terminale DX RH end</p> <p>terminale SX LH end</p>	G960121					
 <p>Terminale chiuso "T4" dx o sx per gola tipo "BP" da utilizzare solo tra cassettiere e lavastoviglie/colonne "T4" RH or LH closure for type "BP" finger rail To be placed only between drawer units and dishwasher/columns</p>							
	<p>terminale DX RH end</p> <p>terminale SX LH end</p>	G960131					
 <p>Gola verticale piatta intermedia tipo "DP" (completa di distanziale) Type "DP" intermediate vertical flat finger rail (complete with spacer)</p>  <p>Sezione gola tipo "DP" Cross section of type "DP" finger rail</p>							
	<p>Piedi H 13 H 96 H 132 H 204 H 228</p> <p>Piedi H 6 H 108 H 144 H 216</p>	G960410	G960430	G960450	G960470	G960420	G960440
 <p>Gola verticale piatta laterale tipo "CP" (completa di distanziale) Type "CP" vertical side flat finger rail (complete with spacer)</p>  <p>Sezione gola tipo "CP" Cross section of type "CP" finger rail</p>							
	<p>Piedi H 13 H 96 H 132 H 204 H 228</p> <p>Piedi H 6 H 108 H 144 H 216</p>	G960310	G960330	G960350	G960370	G960320	G960340

NOZIONI UTILI - gole orizzontali **piatte** per basi

USEFUL INFORMATION - HORIZONTAL **FLAT** FINGER RAILS FOR BASE UNITS

VISTA FRONTALE ZOCCOLO H 6 PER BASI H 90

FRONT VIEW PLINTH H 6 FOR BASE UNITS H 90

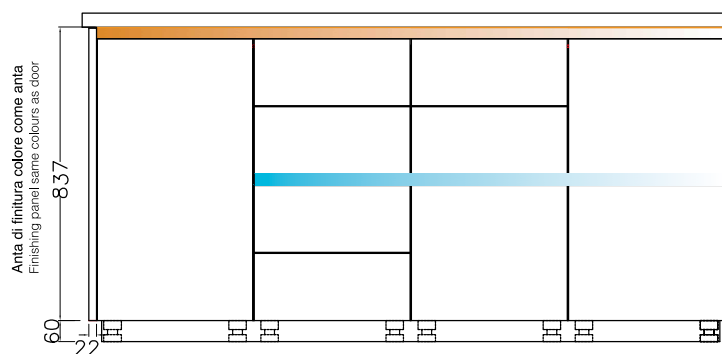
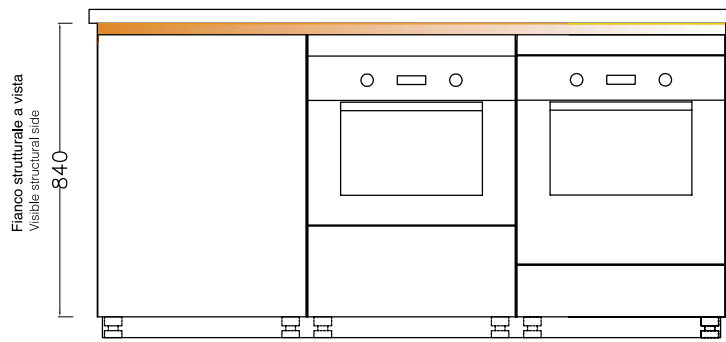

VISTA LATERALE (sezione) ZOCCOLO H 6 PER BASI H 90

SIDE VIEW (CROSS SECTION) PLINTH H 6 FOR BASE UNITS H 90

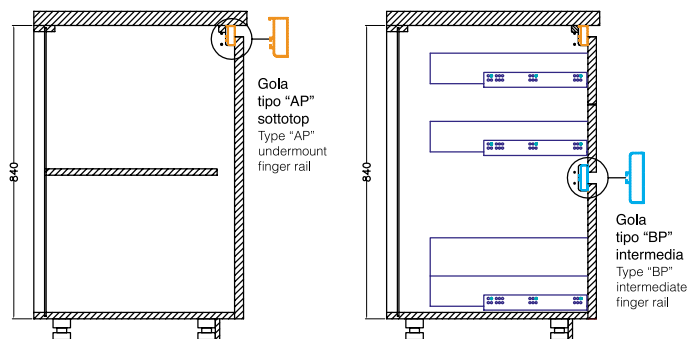

VISTA DALL'ALTO

TOP VIEW

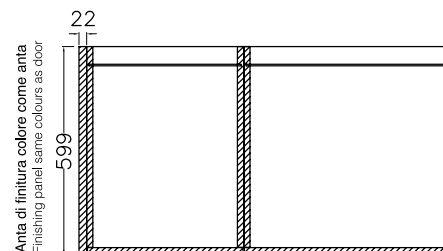
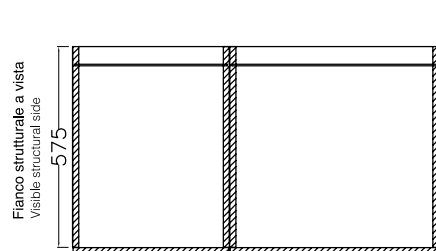

Composizione con ante di finitura laterali: alla dimensione finale della cucina, sommare sempre lo spessore delle ante di finitura (ogni anta 2,2 cm)

Composition with side finishing panels: to the final size of the kitchen, always add the thickness of the finishing panels (each panel 22 mm)

NOZIONI UTILI - gole verticali **piatte** per colonne

USEFUL INFORMATION - VERTICAL **FLAT** FINGER RAILS FOR COLUMNS

VISTA FRONTALE ZOCCOLO H 6

FRONT VIEW PLINTH H 6

N.B.: per la versione Lux sulle colonne il profilo anta è sempre inclinato verticale

Note: door always with vertical inclined profile for the Lux versions' columns

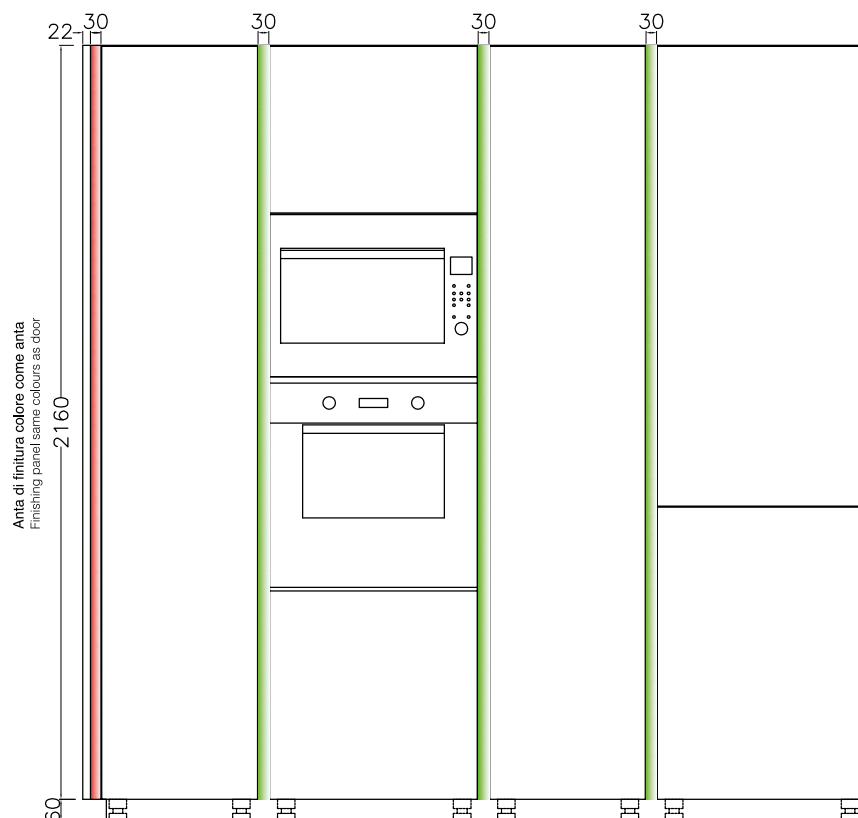

VISTA DALL'ALTO

TOP VIEW

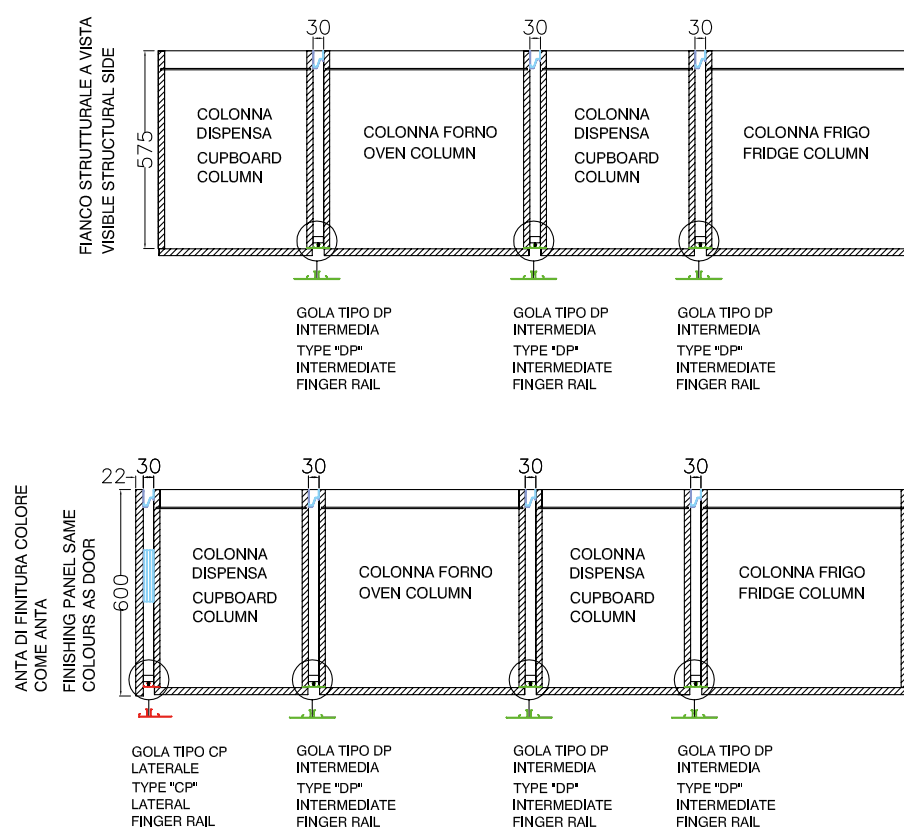

Composizione fianco strutturale
a vista come anta:
alla dimensione finale della cucina,
sommare sempre lo spessore dei
distanziali tra le colonne
(ogni distanziale 3 cm)

Composition with visible side panel to match door:
to the final size of the kitchen, always add the thickness
of the spacers between the two columns (each spacer 3 cm)

Composizione con ante di finitura
laterali, alla dimensione finale della
cucina, sommare sempre lo spessore
dei distanziali tra le colonne
(ogni distanziale 3 cm) e lo spessore
delle ante di finitura (ogni anta 2,2 cm)

Composition with side finishing panels to the final size of the
kitchen, always add the thickness of the spacer between the
two columns (each spacer 3 cm) and the thickness of the
finishing panels (each panel 22 mm)

SP. 22 MM

OLTRE **N**eck
LUX

CARATTERISTICHE TECNICHE

ANTE E FRONTALI CASSETTI

anta sp.22 mm impiallacciata **rovere vintage con nodi e stuccature venatura verticale finitura materica** nei colori: rovere bianco invecchiato (opz.5380), rovere juta invecchiato (opz.5381), rovere corteccia invecchiato (opz.5382), rovere mielato invecchiato (opz.5383), rovere antracite invecchiato (opz.5384), rovere argilla invecchiato (opz.5385), rovere moro invecchiato (opz.5386), rovere naturale invecchiato parquettato (opz.5387), rovere grigio terra (opz.5389) rovere madera termocotto con finto tarlo (opz.5388)

VERSIONE **NECK**

anta squadrata, per gola ad "ELLE"



VERSIONE **LUX** PROFILI E GOLE

di serie: anta profilo inclinata per gola ad "ELLE"
a richiesta: anta profilo inclinata per gola piatta

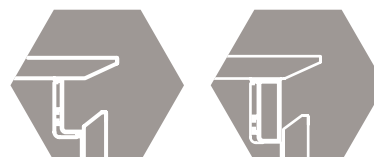

a richiesta: anta profilo alluminio inclinata per gola ad "ELLE"
anta profilo alluminio inclinata per gola piatta

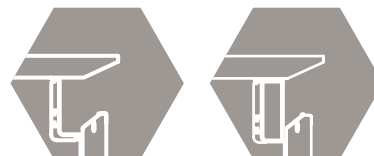

STRUTTURE

ANTE: rovere argilla invecchiato

di serie : nobilitato bianco (opz.001) schiena e ripiano bianco (opz.001)

ANTE: rovere bianco invecchiato, rovere juta invecchiato

di serie : nobilitato visone (opz.948M) schiena e ripiano visone (opz.948M)

ANTE: rovere antracite invecchiato

di serie : nobilitato lavagna (opz.9620) schiena e ripiano lavagna (opz.9620)

ANTE: rovere corteccia invecchiato, rovere mielato invecchiato, rovere moro invecchiato, rovere naturale parquettato, rovere madera termocotto, rovere grigio terra

di serie : nobilitato fango (opz.8860) schiena e ripiano fango (opz.8860)

a richiesta : nobilitato perla d'oriente (opz.940) schiena e ripiano bianco (opz.001)
nobilitato conchiglia (opz.8910) schiena e ripiano conchiglia (opz.8910)
nobilitato argilla (opz.9690) schiena e ripiano argilla (opz.9690)



MENSOLE

di serie: altezza cm 3,8 in laminato come strutture: bianco (opz.001), perla d'oriente (opz.940), visone (opz.948M), lavagna (opz.9620), fango (opz.8860), argilla (opz.9690), conchiglia (opz.8910)

a richiesta: altezza cm 3,8 impiallacciata finiture come ante

ZOCCOLI

vedi pag.49



TH. 22 MM

OLTRE **N**eck **L**UX

TECHNICAL FEATURES

DOORS AND DRAWER FRONTS

22 mm th. veneered door **vintage oak with knots and filler vertical grain textured finish** in the following colours:
white aged oak (opt.5380), jute aged oak (opt.5381), bark aged oak (opt.5382), honey aged oak (opt.5383),
anthracite aged oak (opt.5384), clay aged oak (opt.5385), dark aged oak (opt.5386), parquet-effect natural aged oak (opt.5387)
grey earth oak (opt.5389), heat treated madera oak with worm-eaten effect (opt.5388)

NECK VERSION

square edge door, for "L-SHAPED" finger rail

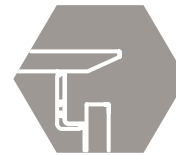

PROFILES AND FINGER RAILS **LUX** VERSION

standard: inclined edge door, for "L-SHAPED" finger rail
on request: inclined edge door, for flat finger rail

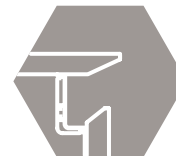

on request: aluminium inclined edge door, for "L-SHAPED" finger rail
aluminium inclined edge door, for flat finger rail

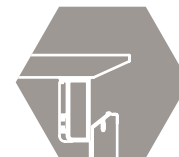
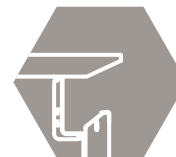

STRUCTURES

DOORS: clay aged oak

standard: melamine-coated white (opt.001), white back panel and shelf (opt.001)

DOORS: white aged oak, jute aged oak

standard: melamine-coated mink (opt.948M), mink back panel and shelf (opt.948M)

DOORS: anthracite aged oak

standard: melamine-coated slate grey (opt.9620), slate grey back panel and shelf (opt.9620)

DOORS: bark aged oak, honey aged oak, dark aged oak, parquet-effect natural aged oak, heat treated madera oak, grey earth oak

standard: melamine-coated mud (opt.8860), mud back panel and shelf (opt.8860)

on request: melamine-coated oriental pearl (opt.940), white back panel and shelf (opt.001)

melamine-coated shell (opt.8910), shell back panel and shelf (opt.8910)

melamine-coated clay (opt.9690), clay back panel and shelf (opt.9690)

SHELVES

standard: height 3.8 cm, in laminate to match structure: white (opt.001), oriental pearl (opt.940),
mink (opt.948M), slate grey (opt.9620), mud (opt.8860), clay (opt.9690), shell (opt.8910)

on request: height 3.8 cm, veneered to match doors

PLINTHS

see page 49

SP. 22 MM TH. 22 MM

OLTRE **Neck** **LUX**

anta finitura materica vintage
door with textured vintage finish



rovere bianco invecchiato
(opz.5380)
white aged oak (opt.5380)



rovere juta invecchiato
(opz.5381)
jute aged oak (opt.5381)



rovere corteccia invecchiato
(opz.5382)
bark aged oak (opt.5382)



rovere mielato invecchiato
(opz.5383)
honey aged oak (opt.5383)

Neck



particolare anta squadrata
squared edge door detail



rovere antracite invecchiato
(opz.5384)
anthracite aged oak
(opt.5384)



rovere argilla invecchiato
(opz.5385)
clay aged oak (opt.5385)



rovere moro invecchiato
(opz.5386)
dark aged oak (opt.5386)



rovere naturale invecchiato
parquetto (opz.5387)
parquet-effect natural aged
oak (opt.5387)

LUX



particolare anta inclinata
inclined edge door detail



particolare anta inclinata
con profilo alluminio
inclined edge door with
aluminium profile detail



rovere maderia termocotta
con finto tarlo (opz.5388)
heat treated maderia oak
with worm-eaten effect
(opt.5388)



particolare anta con finto tarlo
door with worm-eaten effect detail



rovere grigio terra (opz.5389)
grey earth oak (opt.5389)



SP. 22 MM

OLTRE Neck
LUX

CARATTERISTICHE TECNICHE

ANTE E FRONTALI
CASSETTI

anta sp.22 mm con pannello in truciolare E1 rivestito lato esterno con fenix spessore 9/10 lato interno in laminato spessore 9/10 in tinta come esterno, bordata in polipropilene con incollaggio laser spessore 10/10; nella versione Lux con presa maniglia il lato inclinato è bordato in polipropilene spessore 10/10 incollaggio poliuretano nei colori: bianco caldo (opz.7446), castoro (opz.8864), nero (opz.7861), grigio bromo (opz.9628), fumo (opz.9629), cacao orinoco (opz.8865), beige arizona (opz.7705), grigio efeso (opz.9630), blu fes (opz.8301), bianco dover (opz.7449)

VERSIONE **NECK**

anta squadrata, per gola ad "ELLE"

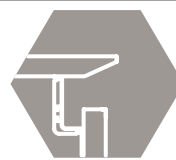
VERSIONE **LUX**
PROFILI E GOLE

di serie: anta profilo inclinata per gola ad "ELLE"
a richiesta: anta profilo inclinata per gola piatta



a richiesta: anta profilo alluminio inclinata per gola ad "ELLE"
anta profilo alluminio inclinata per gola piatta

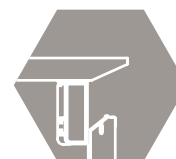
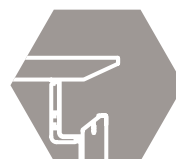

STRUTTURE

ANTE: bianco caldo, bianco dover

di serie : nobilitato bianco (opz.001) schiena e ripiano bianco (opz.001)

ANTE: fumo, beige arizona

di serie : nobilitato visone (opz.948M) schiena e ripiano visone (opz.948M)

ANTE: nero, grigio bromo, blu fes

di serie : nobilitato lavagna (opz.9620) schiena e ripiano lavagna (opz.9620)

ANTA: castoro

di serie : nobilitato conchiglia (opz.8910) schiena e ripiano conchiglia (opz.8910)

ANTA: cacao orinoco

nobilitato fango (opz.8860) schiena e ripiano fango (opz.8860)

ANTA: grigio efeso

nobilitato argilla (opz.9690) schiena e ripiano argilla (opz.9690)

a richiesta : nobilitato perla d'oriente (opz.940) schiena e ripiano bianco (opz.001)



MENSOLE

di serie: altezza cm 3,8 in laminato come strutture: bianco (opz.001), perla d'oriente (opz.940), visone (opz.948M), lavagna (opz.9620), fango (opz.8860), argilla (opz.9690), conchiglia (opz.8910)

a richiesta: altezza cm 3,8 finiture come ante

ZOCOLI

vedi pag.49



TH. 22 MM

OLTRE Neck LUX

TECHNICAL FEATURES

DOORS AND DRAWER FRONTS

22 mm th. door with E1 chipboard panel with exterior coated in 9/10 thickness Fenix and interior in 9/10 thickness laminate in the same colour as the exterior. Edge in 10/10 thickness polypropylene with laser gluing. The Lux version with handle grip has 10/10 thickness polypropylene edging on the inclined side with polyurethane gluing in the following colours: warm white (opt.7446), beaver (opt.8864), black (opt.7861), bromine grey (opt.9628), smoke (opt.9629), cocoa orinoco (opt.8865), arizona beige (opt.7705), ephesus grey (opt.9630), blue fes (opt.8301), dover white (opt.7449)

NECK VERSION

square edge door, for "L-SHAPED" finger rail

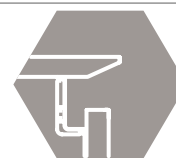

PROFILES AND FINGER RAILS LUX VERSION

standard: inclined edge door, for "L-SHAPED" finger rail
on request: inclined edge door, for flat finger rail

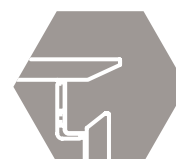

on request: aluminium inclined edge door, for "L-SHAPED" finger rail
aluminium inclined edge door, for flat finger rail

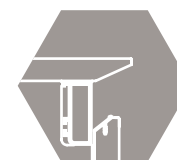
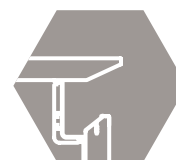

STRUCTURES

DOORS: warm white, dover white
standard: melamine-coated white (opt.001), white back panel and shelf (opt.001)
DOORS: smoke, arizona beige
standard: melamine-coated mink (opt.948M), mink back panel and shelf (opt.948M)
DOORS: black, bromine grey, fles blue
standard: melamine-coated slate grey (opt.9620), slate grey back panel and shelf (opt.9620)
DOOR: beaver
standard: melamine-coated shell (opt.8910), shell back panel and shelf (opt.8910)
DOOR: orinoco cocoa
standard: melamine-coated mud (opt.8860), mud back panel and shelf (opt.8860)
DOOR: ephesus grey
standard: melamine-coated clay (opt.9690), clay back panel and shelf (opt.9690)

on request: melamine-coated oriental pearl (opt.940), white back panel and shelf (opt.001)

SHELVES

standard: height 3.8 cm, in laminate to match structure: white (opt.001) oriental pearl (opt.940), mink (opt.948M), slate grey (opt.9620), mud (opt.8860), clay (opt.9690), shell (opt.8910)

on request: height 3.8 cm, finished to match doors

PLINTHS

see page 49

cod.

G51_{Neck} G61_{Lux}

Fenix

SP. 22 MM TH. 22 MM

OLTRE **N**eck **L**UX

anta finitura fenix

door with fenix finish

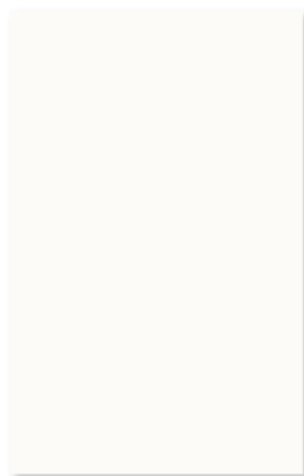

bianco caldo (opz.7446)
warm white (opt.7446)



castoro (opz.8864)
beaver (opt.8864)

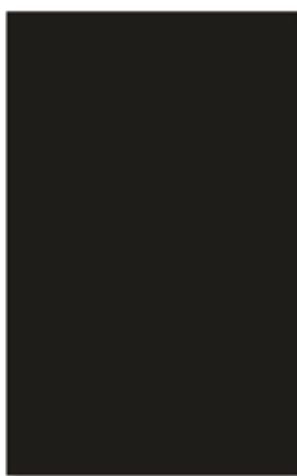

nero (opz.7861)
black (opt.7861)



grigio bromo (opz.9628)
bromine grey (opt.9628)



fumo (opz.9629)
smoke (opt.9629)



cacao orinoco (opz.8865)
cocoa orinoco (opt.8865)

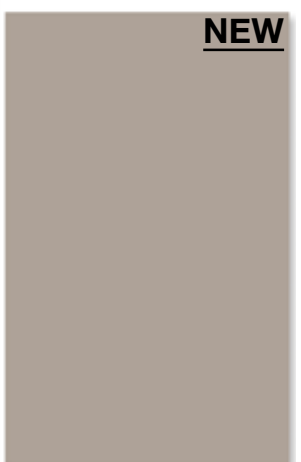

beige arizona (opz.7705)
arizona beige (opt.7705)



grigio efeso (opz.9630)
ephesus grey (opt.9630)



blu fes (opz.8301)
blue fes (opt.8301)

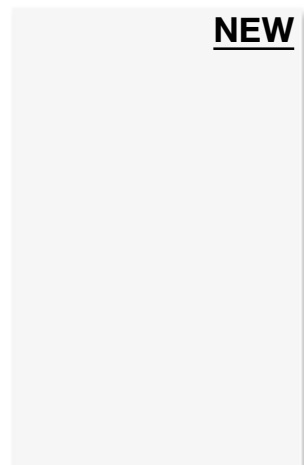

bianco dover (opz.7449)
dover white (opt.7449)

Neck

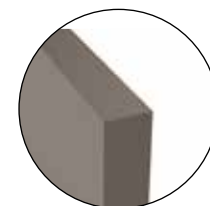

particolare anta squadrata
squared edge door detail

LUX

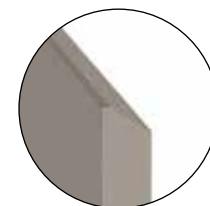

particolare anta inclinata
inclined edge door detail

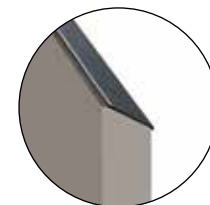

particolare anta inclinata
con profilo alluminio
inclined edge door with
aluminium profile detail

Informazioni tecniche

FENIX NTM™

È un nuovissimo prodotto per l'interior design sviluppato da Arpa Industriale.

Prodotto grazie a resine di nuova generazione, questo materiale intelligente si contraddistingue per una superficie dalle proprietà straordinarie.

Con una bassa riflessione della luce, la sua superficie è estremamente opaca (valore di riflessione speculare: 1,5 e 60°) e anti impronte digitali.

Grazie all'utilizzo della nanotecnologia, eventuali micrograffi possono essere riparati termicamente ed è inoltre piacevolmente soft touch.

FENIX NTM™ è Made in Italy.

FENIX NTM™ è un materiale innovativo di Arpa Industriale creato per l'interior design prodotto mediante

l'applicazione simultanea di calore (circa 150°C) e alta pressione specifica (> 7 MPa) per ottenere un prodotto omogeneo non poroso con densità elevata.

Il suo core è composto da carta impregnata in resina termoindurente mentre la superficie decorativa, ottenuta con l'ausilio di nanotecnologie, è costituita da una carta decorativa trattata con resine di nuova generazione frutto della ricerca di Arpa Industriale.

FENIX NTM™ è un materiale che si distingue per particolari caratteristiche quali: alta resistenza al graffio e al calore, anti impronta, morbidezza al tatto, bassa riflessione della luce, riparabilità termica dei micrograffi, alta attività di abbattimento della carica batterica.

FENIX NTM™ è un marchio registrato da Arpa Industriale.

FENIX NTM™ è placcato su truciolare idrorepellente e il top è bordato sui lati a vista con polipropilene spessore 1 mm in tinta.

Technical information

FENIX NTM™

It is a brand new interior design product developed by Arpa Industriale.

Using the most modern resins, this intelligent material stands out for the extraordinary characteristics of its surface.

The matt surface has an exceptionally low reflectivity (specular reflection index: 1.5 and 60°) and is highly resistant to hand and finger prints.

The material uses nanotechnology to enable micro-scratches to be healed thermally, and it also has a very pleasant soft touch effect.

FENIX NTM™ is Made in Italy.

FENIX NTM™ is an innovative interior design product from Arpa Industriale, made by applying heat (around 150°C) and high pressure (> 7 MPa) to obtain a non-porous very dense material.





















Its core is composed of paper impregnated with thermosetting resin, while the surface, which employs nanotechnology processes, is composed of a decorative paper treated with the most recently developed resins from the Arpa Industriale research labs.

FENIX NTM™ stands out for its exceptional resistance to scratching, heat and hand and finger prints, soft touch, low reflectivity, thermal healing of micro-scratches, and effective anti-bacterial action.

FENIX NTM™ is a registered trademark of Arpa Industriale.

FENIX NTM™ is fixed on waterproof fiberboard and the top is trimmed on visible sides with 1 mm polypropylene in matching colour.

FENIX NTM™

- | | | | |
|---|--|---|--|
|  | Resistenza ai graffi e all'abrasione
Resistance to scratches and abrasion |  | Stabilità dimensionale in presenza di elevata variazione termica
Dimensional stability even at high temperature changes |
|  | Alta attività di abbattimento della carica batterica
Enhanced anti-bacterial properties |  | Resistenza all'urto
Resistance to impact |
|  | Igienico
Hygienic |  | Stabilità alla luce
Lightfastness |
|  | Idoneo al contatto con gli alimenti
Suitable for contact with food |  | Resistenza al calore secco
Resistance to dry heat |
|  | Facile da pulire
Easy to clean |  | Eccellente intensità e profondità del colore
Excellent intensity and colour depth |
|  | Antimuffa
Mold-resistant |  | Resistenza allo strofinamento
Rub resistance |
|  | Antistatico
Antistatic |  | Elevata resistenza a solventi acidi e ai reagenti di uso domestico
High resistance to acid solvents and household reagents |
|  | Idrorepellente
Water proof |  | Autoportante (solo per gli spessori 10 e 12 mm)
Self-supporting (only for 10 and 12 mm) |
|  | Bassa riflessione della luce, superficie estremamente opaca
Low light reflection, extremely matt surface |  | Riparabilità termica dei micrograffi
Repairability thermal micro-scratches |
|  | Anti-impronta
Anti-huella digital |  | Morbidezza al tatto
Soft to the touch |

FENIX NTM™

RIPARABILITÀ TERMICA DEI MICROGRAFFI
Nanotech matt material for interior design



ISTRUZIONI PER LA MANUTENZIONE.
MAINTENANCE

FERRO DA STIRO.
CLOTHES IRON

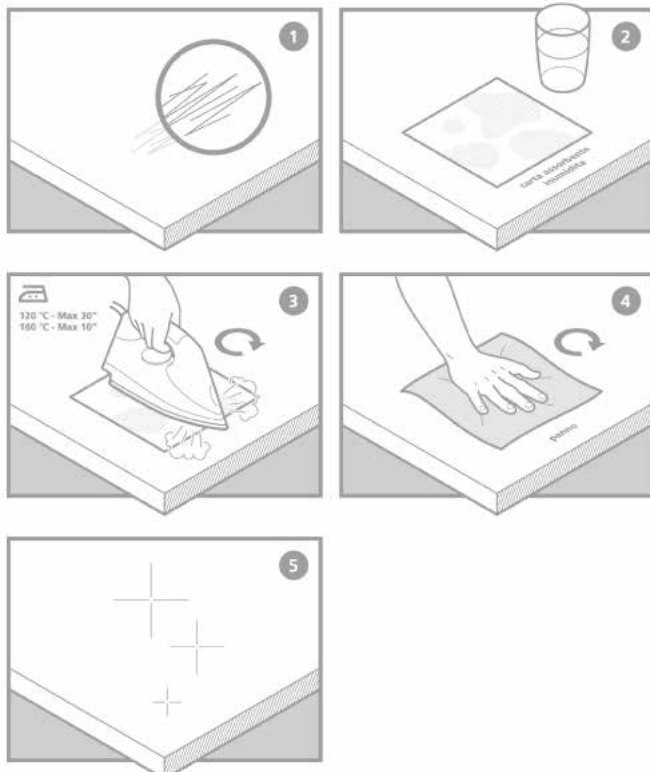

ISTRUZIONI PER LA MANUTENZIONE.
MAINTENANCE

SPUGNA DI SCHIUMA MELAMMINICA.
MELAMINE FOAM SPONGE

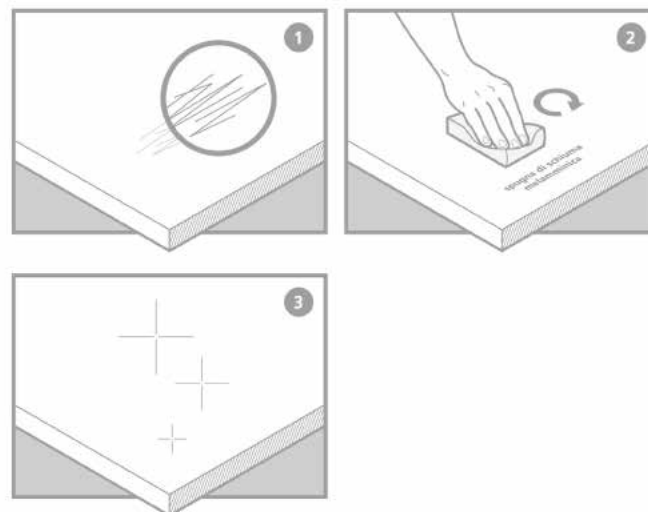

Visiti fenixntm.com
go to fenixntm.com

per scoprire tutte le proprietà
for further details

made in Italy by Arpa Industriale

SP. 22 MM

OLTRE **N**eck
LUX

CARATTERISTICHE TECNICHE

ANTE E FRONTALI CASSETTI

anta sp.22 mm composta da un supporto in agglomerato di legno rivestito su due lati con pannelli in HDF classe E1, ricoperto in malta cementizia nei colori: old white (opz.MA11), old grey (opz.MA12), old dark (opz.MA13), old black (opz.MA14)

VERSIONE **NECK**

anta squadrata, per gola ad "ELLE"

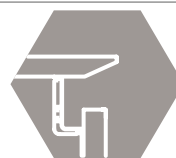

VERSIONE **LUX** PROFILI E GOLE

di serie: anta profilo inclinata per gola ad "ELLE"
a richiesta: anta profilo inclinata per gola piatta

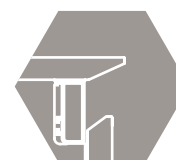
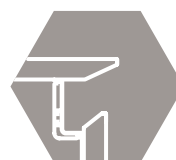

a richiesta: anta profilo alluminio inclinata per gola ad "ELLE"
anta profilo alluminio inclinata per gola piatta

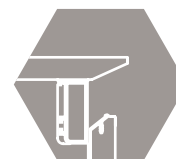
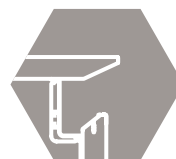

N.B.: maggiorazione per profilo vedi prezzi fascia F18

STRUTTURE

ANTA: old white

di serie : nobilitato conchiglia (opz.8910) schiena e ripiano conchiglia (opz.8910)

ANTA: old grey, old black

di serie : nobilitato lavagna (opz.9620) schiena e ripiano lavagna (opz.9620)

ANTA: old dark

di serie : nobilitato fango (opz.8860) schiena e ripiano fango (opz.8860)

a richiesta : nobilitato perla d'oriente (opz.940) schiena e ripiano bianco (opz.001)
nobilitato bianco (opz.001) schiena e ripiano bianco (opz.001)
nobilitato visone (opz.948M) schiena e ripiano visone (opz.948M)
nobilitato argilla (opz.9690) schiena e ripiano argilla (opz.9690)



MENSOLE

di serie: altezza cm 3,8 in laminato come strutture: bianco (opz.001), perla d'oriente (opz.940), visone (opz.948M), lavagna (opz.9620), fango (opz.8860), argilla (opz.9690), conchiglia (opz.8910)

a richiesta: altezza cm 3,8 finiture come ante

ZOCCOLI

vedi pag.49



TH. 22 MM

OLTRE **N**eck **L**UX

TECHNICAL FEATURES

DOORS AND DRAWER FRONTS

22 mm th. door comprised of a support in wood composite covered on two sides with class E1 HDF panels, covered in cement mortar in the following colours: old white (opt.MA11), old grey (opt.MA12), old dark (opt.MA13), old black (opt.MA14)

NECK VERSION

square edge door, for "L-SHAPED" finger rail

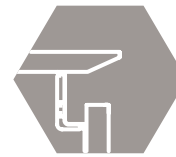

PROFILES AND FINGER RAILS LUX VERSION

standard: inclined edge door, for "L-SHAPED" finger rail
on request: inclined edge door, for flat finger rail



on request: aluminium inclined edge door, for "L-SHAPED" finger rail
aluminium inclined edge door, for flat finger rail

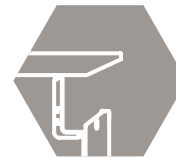

N.B.: surcharge for edge, see category F18 prices

STRUCTURES

DOOR: old white
standard: melamine-coated shell (opt.8910), shell back panel and shelf (opt.8910)
DOORS: old grey, old black
standard: melamine-coated slate grey (opt.9620), slate grey back panel and shelf (opt.9620)
DOOR: old dark
standard: melamine-coated mud (opt.8860), mud back panel and shelf (opt.8860)

on request: melamine-coated oriental pearl (opt.940), white back panel and shelf (opt.001)
melamine-coated white (opt.001), white back panel and shelf (opt.001)
melamine-coated mink (opt. 948M), mink back panel and shelf (opt.948M)
melamine-coated clay (opt.9690), clay back panel and shelf (opt.9690)

SHELVES

standard: : height 3.8 cm, in laminate to match structure: white (opt.001) oriental pearl (opt.940), mink (opt.948M), slate grey (opt.9620), mud (opt.8860), clay (opt.9690), shell (opt.8910)

on request: height 3.8 cm, finished to match doors

PLINTHS

see page 49

SP. 22 MM TH. 22 MM

OLTRE Neck
Lux

anta finitura malta
door with mortar finish



old white (opz.MA11)



old grey (opz.MA12)



old dark (opz.MA13)



old black (opz.MA14)

Neck



particolare anta squadrata
squared edge door detail

LUX



particolare anta inclinata
inclined edge door detail



particolare anta inclinata
con profilo alluminio
vedi maggiorazione prezzi F18
inclined edge door with
aluminium profile detail
see surcharge on "F18" band
of the pricelist

Informazioni tecniche

La malta cementizia è realizzata con impasti derivati da miscele, attentamente studiate, di leganti idraulici ed inerti, a base di farine di quarzo e sabbie minerali a granulometria controllata, esente da sali ed impurezze. A questo formulato viene aggiunta una percentuale (1÷2%) di polimeri elastomerici stabilizzanti, per evitare tensioni o crepe generate da sbalzi di temperatura e sollecitazioni dinamiche particolari. Prima dell'applicazione le superfici vengono trattate per poter permettere l'applicazione del rasante. Quest'ultimo viene applicato rigorosamente a mano da esperti artigiani su pannelli compositi. Sulla superficie, una volta asciutta, vengono applicate più mani di rivestimento acrilico trasparente: questo trattamento protegge la superficie da infiltrazioni di unto e sporco.

La particolarità del prodotto e soprattutto il modo di applicazione, ne determinano un aspetto cementizio con alcune caratteristiche proprie della sua natura, quali piccole imperfezioni, piccoli fori ed angoli non perfettamente squadri e segni disomogenei della spatola, che esaltano la lavorazione artigianale.

Uso e manutenzione

La collezione è caratterizzata da un'adeguata resistenza alle abrasioni, ai graffi e alle possibili macchie. È comunque molto importante un corretto trattamento e una corretta manutenzione del prodotto.

Per quanto concerne la pulizia delle superfici è indicato l'uso di detergenti neutri diluiti in acqua tiepida (proporzione 1:10, ad esempio 0,1 L di prodotto pulente e 1 L di acqua) e passati con dei semplici panni in microfibra. È consigliato risciacquare i detergenti usati, in quanto si riduce notevolmente il rischio di usura dello strato di rivestimento a protezione della superficie. È altamente sconsigliato l'utilizzo di prodotti concentrati e di sistemi di pulizia a vapore.

Technical Information

Cement mortar is made from pastes derived from carefully blended mixtures of inert hydraulic bonding agents, comprised of quartz and mineral sands with controlled granule sizes free from salts and impurities. This formula is then blended with a percentage (1-2%) of stabilising elastomeric polymers to prevent tensions and cracks caused by temperature changes and dynamic stresses. The surfaces are treated before application to allow the coating to adhere. The coating is then applied by hand by expert craftsmen onto the composite panels. Once dry, the surface is then treated with a transparent acrylic coating: this treatment protects the surface against grease and dirt.

The special qualities of the product, and in particular the application method, create a cement effect that has certain inherent properties, such as small imperfections, tiny holes, and corners that aren't perfectly square. There may also be uneven trowel marks, all of which highlight the craft manufacture.

Use and maintenance

This collection is characterised by good resistance to abrasion, scratches and stains.

It is nonetheless very important to treat and maintain the product correctly.

With regards to cleaning surfaces, we recommend the use of neutral detergents diluted in tepid water (dilution 1:10, e.g. 0.1 L of cleaning product in 1 L of water) applied using a micro-fibre cloth.

We recommend rinsing off any detergents used as this considerably reduces the wear on the coating protecting the surface. The use of concentrated cleaning products and steam cleaning systems should be strictly avoided.

sezione anta
door section

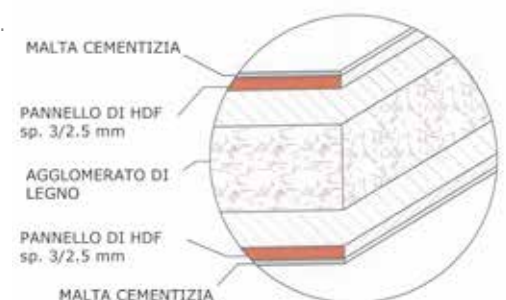



SP. 22 MM

OLTRE **N**eck
LUX

CARATTERISTICHE TECNICHE

ANTE E FRONTALI
CASSETTI

anta sp.22 mm in mdf laccata **finitura opaca testurizzata soft nei colori**

 [CLICCA QUI PER LA GAMMA COLORI DISPONIBILI](#)

 [CLICK HERE FOR THE RANGE OF AVAILABLE COLORS](#)

VERSIONE **NECK**

anta squadrata, per gola ad "ELLE"

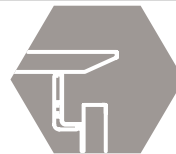

VERSIONE **LUX**
PROFILI E GOLE

di serie: anta profilo inclinata per gola ad "ELLE"
a richiesta: anta profilo inclinata per gola piatta

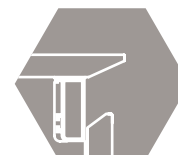

a richiesta: anta profilo alluminio inclinata per gola ad "ELLE"
anta profilo alluminio inclinata per gola piatta

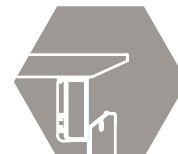

STRUTTURE

di serie: nobilitato bianco (opz.001) schiena e ripiano bianco (opz.001)

a richiesta: nobilitato visone (opz.948M) schiena e ripiano visone (opz.948M)
nobilitato lavagna (opz.9620) schiena e ripiano lavagna (opz.9620)
nobilitato perla d'oriente (opz.940) schiena e ripiano bianco (opz.001)
nobilitato fango (opz.8860) schiena e ripiano fango (opz.8860)
nobilitato conchiglia (opz.8910) schiena e ripiano conchiglia (opz.8910)
nobilitato argilla (opz.9690) schiena e ripiano argilla (opz.9690)



MENSOLE

di serie: altezza cm 3,8 in laminato come strutture: bianco (opz.001), perla d'oriente (opz.940), visone (opz.948M), lavagna (opz.9620), fango (opz.8860), argilla (opz.9690), conchiglia (opz.8910)

a richiesta: altezza cm 3,8 laccate opache finiture come ante

ZOCCOLI

[vedi pag.49](#)



SP. 22 MM

OLTRE **N**eck
LUX

CARATTERISTICHE TECNICHE

ANTE E FRONTALI CASSETTI

anta sp.22 mm in mdf laccata **finitura lucida spazzolata nei colori**

 [CLICCA QUI PER LA GAMMA COLORI DISPONIBILI](#)

 [CLICK HERE FOR THE RANGE OF AVAILABLE COLORS](#)

VERSIONE **NECK**

anta squadrata, per gola ad "ELLE"

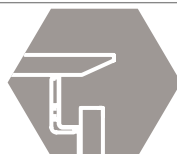

VERSIONE **LUX** PROFILI E GOLE

di serie: anta profilo inclinata per gola ad "ELLE"
a richiesta: anta profilo inclinata per gola piatta

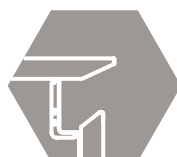

a richiesta: anta profilo alluminio inclinata per gola ad "ELLE"
anta profilo alluminio inclinata per gola piatta

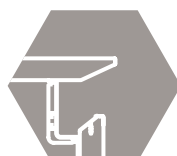

STRUTTURE

di serie: nobilitato bianco (opz.001) schiena e ripiano bianco (opz.001)

a richiesta: nobilitato visone (opz.948M) schiena e ripiano visone (opz.948M)
nobilitato lavagna (opz.9620) schiena e ripiano lavagna (opz.9620)
nobilitato perla d'oriente (opz.940) schiena e ripiano bianco (opz.001)
nobilitato fango (opz.8860) schiena e ripiano fango (opz.8860)
nobilitato conchiglia (opz.8910) schiena e ripiano conchiglia (opz.8910)
nobilitato argilla (opz.9690) schiena e ripiano argilla (opz.9690)



MENSOLE

di serie: altezza cm 3,8 in laminato come strutture: bianco (opz.001), perla d'oriente (opz.940), visone (opz.948M), lavagna (opz.9620), fango (opz.8860), argilla (opz.9690), conchiglia (opz.8910)

a richiesta: altezza cm 3,8 laccate lucide finiture come ante

ZOCCOLI

vedi pag.49



TH. 22 MM

OLTRE **N**eck **L**ux

TECHNICAL FEATURES

DOORS AND DRAWER FRONTS

22 mm th. MDF door, with **soft textured matt lacquered finish in the following colours:**

 [CLICCA QUI PER LA GAMMA COLORI DISPONIBILI](#)

 [CLICK HERE FOR THE RANGE OF AVAILABLE COLORS](#)

NECK VERSION

square edge door, for "L-SHAPED" finger rail

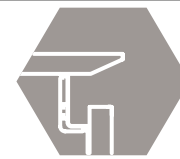

PROFILES AND FINGER RAILS LUX VERSION

standard: inclined edge door, for "L-SHAPED" finger rail
on request: inclined edge door, for flat finger rail

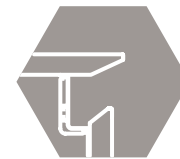

on request: aluminium inclined edge door, for "L-SHAPED" finger rail
aluminium inclined edge door, for flat finger rail



STRUCTURES

standard: melamine-coated white (opt.001), white back panel and shelf (opt.001)

on request: melamine-coated mink (opt.948M), mink back panel and shelf (opt.948M)
melamine-coated slate grey (opt.9620), slate grey back panel and shelf (opt.9620)
melamine-coated oriental pearl (opt.940), white back panel and shelf (opt.001)
melamine-coated mud (opt.8860), mud back panel and shelf (opt.8860)
melamine-coated shell (opt.8910), shell back panel and shelf (opt.8910)
melamine-coated clay (opt.9690), clay back panel and shelf (opt.9690)

SHELVES

standard: : height 3.8 cm, in laminate to match structure: white (opt.001) oriental pearl (opt.940), mink (opt.948M), slate grey (opt.9620), mud (opt.8860), clay (opt.9690), shell (opt.8910)

on request: height 3.8 cm, matt lacquered finish to match doors

PLINTHS

[see page 49](#)

TH. 22 MM

OLTRE

Neck
LUX

TECHNICAL FEATURES

DOORS AND DRAWER FRONTS

22 mm th. MDF door, with brushed glossy lacquered finish in the following colours:

 [CLICCA QUI PER LA GAMMA COLORI DISPONIBILI](#)

 [CLICK HERE FOR THE RANGE OF AVAILABLE COLORS](#)

NECK VERSION

square edge door, for "L-SHAPED" finger rail

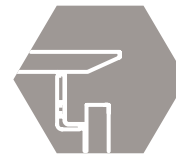

PROFILES AND FINGER RAILS LUX VERSION

standard: inclined edge door, for "L-SHAPED" finger rail
on request: inclined edge door, for flat finger rail

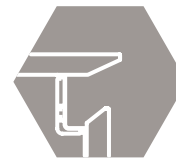

on request: aluminium inclined edge door, for "L-SHAPED" finger rail
aluminium inclined edge door, for flat finger rail

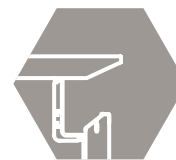

STRUCTURES

standard: melamine-coated white (opt.001), white back panel and shelf (opt.001)

on request: melamine-coated mink (opt.948M), mink back panel and shelf (opt.948M)
melamine-coated slate grey (opt.9620), slate grey back panel and shelf (opt.9620)
melamine-coated oriental pearl (opt.940), white back panel and shelf (opt.001)
melamine-coated mud (opt.8860), mud back panel and shelf (opt.8860)
melamine-coated shell (opt.8910), shell back panel and shelf (opt.8910)
melamine-coated clay (opt.9690), clay back panel and shelf (opt.9690)

SHELVES

standard: : height 3.8 cm, in laminate to match structure: white (opt.001) oriental pearl (opt.940), mink (opt.948M), slate grey (opt.9620), mud (opt.8860), clay (opt.9690), shell (opt.8910)

on request: height 3.8 cm, glossy lacquered finish to match doors

PLINTHS

[see page 49](#)

cod. **G53**_{Neck} **G63**_{Lux}

Laccato Opaco
Matt Lacquered

SP. 22 MM TH. 22 MM

ante laccate opache matt doors lacquered

OLTRE **N**eck
LUX



Neck

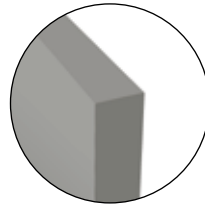

particolare anta squadrata
squared edge door detail

LUX

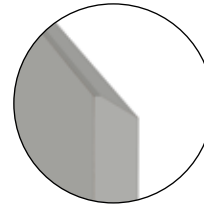

particolare anta inclinata
inclined edge door detail



particolare anta inclinata
con profilo alluminio
inclined edge door with
aluminium profile detail

cod. **G54**_{Neck} **G64**_{Lux}

Laccato Lucido Spazzolato
Brushed Glossy Lacquered

SP. 22 MM TH. 22 MM

ante laccate lucide glossy doors lacquered



cassetto grigio bromo (opz.9534)
bromine grey drawer (opt.9534)



OLTRE **N**eck **L**UX

Neck

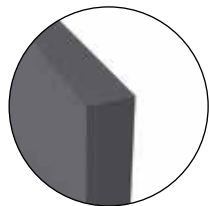

particolare anta squadrata
squared edge door detail

LUX

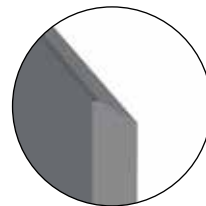

particolare anta inclinata
inclined edge door detail

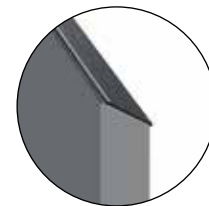

particolare anta inclinata
con profilo alluminio
inclined edge door with
aluminium profile detail

cod.

G54Neck **G64**Lux

Laccato Vintage

SP. 22 MM

OLTRE **N**eck
LUX

CARATTERISTICHE TECNICHE

ANTE E FRONTALI CASSETTI

anta sp.22 mm in mdf laccata **finitura semilucida effetto metallo vintage** nei colori:
peltro (opz.9549), ferro (opz.9506), bronzo (opz.8904)

anta sp.22 mm in mdf laccata **finitura semilucida effetto metallo vintage spazzolato** nei colori:
bronzo anticato (opz.8909), rame anticato (opz.8159), nichel (opz.9505), bronzo brunito (opz.8903), grafite (opz.9508), urban (opz.7894)

VERSIONE **NECK**

anta squadrata, per gola ad "ELLE"

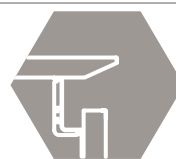

VERSIONE **LUX** PROFILI E GOLE

di serie: anta profilo inclinata per gola ad "ELLE"
a richiesta: anta profilo inclinata per gola piatta

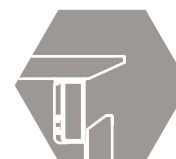

a richiesta: anta profilo alluminio inclinata per gola ad "ELLE"
anta profilo alluminio inclinata per gola piatta

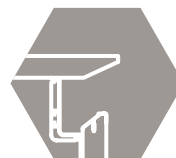

STRUTTURE

ANTE: peltro, ferro, urban, grafite

di serie: nobilitato lavagna (opz.9620) schiena e ripiano lavagna (opz.9620)

ANTE: bronzo, rame anticato, bronzo brunito, bronzo anticato

di serie: nobilitato fango (opz.8860) schiena e ripiano fango (opz.8860)

ANTA: nichel

di serie: nobilitato visone (opz.948M) schiena e ripiano visone (opz.948M)

a richiesta: nobilitato bianco (opz.001) schiena e ripiano bianco (opz.001)
nobilitato perla d'oriente (opz.940) schiena e ripiano bianco (opz.001)
nobilitato conchiglia (opz.8910) schiena e ripiano conchiglia (opz.8910)
nobilitato argilla (opz.9690) schiena e ripiano argilla (opz.9690)



MENSOLE

di serie: altezza cm 3,8 in laminato come strutture: bianco (opz.001), perla d'oriente (opz.940), visone (opz.948M), lavagna (opz.9620), fango (opz.8860), argilla (opz.9690), conchiglia (opz.8910)

a richiesta: altezza cm 3,8 finiture come ante

ZOCCOLI

vedi pag.49



TH. 22 MM

OLTRE

Neck
LUX

TECHNICAL FEATURES

DOORS AND DRAWER FRONTS

22 mm th. door in mdf with **vintage metal effect semi-gloss lacquer finish** in the following colours: pewter (opt. 9549), iron (opt. 9506), bronze (opt. 8904)

22 mm th. door in mdf with **vintage metal effect semi-gloss lacquer brushed finish** in the following colours: antique bronze (opt. 8909), antique copper (opt. 8159), nickel (opt. 9505), burnished bronze (opt. 8903), graphite (opt. 9508), urban (opt. 7894)

NECK VERSION

square edge door, for "L-SHAPED" finger rail

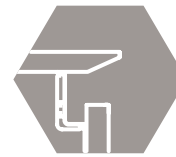

PROFILES AND FINGER RAILS LUX VERSION

standard: inclined edge door, for "L-SHAPED" finger rail
on request: inclined edge door, for flat finger rail

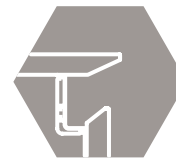

on request: aluminium inclined edge door, for "L-SHAPED" finger rail
aluminium inclined edge door, for flat finger rail

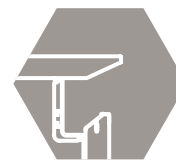

STRUCTURES

DOORS: pewter, iron, urban, graphite

standard: melamine-coated slate grey (opt.9620), slate grey back panel and shelf (opt.9620)

DOORS: bronze, antique copper, burnished bronze, antique bronze

standard: melamine-coated mud (opt.8860), mud back back panel and shelf (opt.8860)

DOOR: nickel

standard: melamine-coated mink (opt.948M), mink back panel and shelf (opt.948M)

on request: melamine-coated white (opt.001), white back panel and shelf (opt.001)

melamine-coated oriental pearl (opt.940), white back panel and shelf (opt.001)

melamine-coated shell (opt.8910), shell back panel and shelf (opt.8910)

melamine-coated clay (opt.9690), clay back panel and shelf (opt.9690)

SHELVES

standard: : height 3.8 cm, in laminate to match structure: white (opt. 001) oriental pearl (opt. 940), mink (opt. 948M), slate grey (opt. 9620), mud (opt. 8860), clay (opt.9690), shell (opt.8910)

on request: height 3.8 cm, finished to match doors

PLINTHS

see page 49

SP. 22 MM TH. 22 MM

ante laccate vintage effetto metallo
lacquered vintage doors metal effect

OLTRE **N**eck
LUX



peltro (opz.9549)
pewter (opt.9549)



ferro (opz.9506)
iron (opt.9506)



bronzo (opz.8904)
bronze (opt.8904)

ante laccate vintage effetto spazzolato
lacquered vintage doors brushed effect



bronzo brunito (opz.8903)
burnished bronze (opt.8903)



grafite (opz.9508)
graphite (opt.9508)



nichel (opz.9505)
nickel (opt.9505)



bronzo anticato (opz.8909)
antique bronze (opt.8909)



rame anticato (opz.8159)
antique copper (opt.8159)



urban (opz.7894)
urban (opt.7894)

Neck

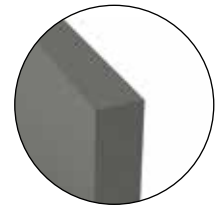

particolare anta squadrata
squared edge door detail

LUX

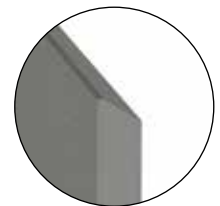

particolare anta inclinata
inclined edge door detail



particolare anta inclinata
con profilo alluminio
inclined edge door with
aluminium profile detail

OLTRE Neck Telaio alluminio

Aluminium frame

Vetro
Glass

abbinabile alle versioni: G50-G51-G52-G53-G54

matched with versions: G50-G51-G52-G53-G54

di serie: telaio alluminio sp.22 mm verniciato a polvere nero,
vetro temperato bronzo o fumè trasparente sp.4 mm

standard: 22mm th. aluminium frame with black powder coating,
4mm th. tempered bronze or smoked transparent glass

NEW



vetro bronzo (opz.NBZ)
bronze glass (opt.NBRZ)

NEW



vetro fumè (opz.NFUM)
smoked glass (opt.NFUM)



particolare telaio svasatura esterna
detail frame with external flared

Neck

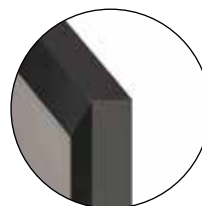

particolare anta squadrata
squared edge door detail

SP. 22 MM TH. 22 MM

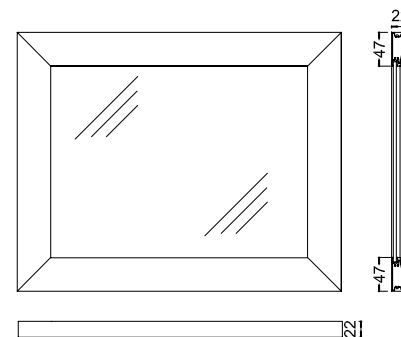

a richiesta: telaio alluminio sp.22 mm finitura urban ossidato
vetro temperato bronzo o fumè trasparente sp.4 mm

on request: 22 mm th. aluminium frame with urban oxidized finish,
4mm th. tempered bronze or smoked transparent glass

NEW



vetro bronzo (opz.NUBZ)
bronze glass (opt.NUBZ)

NEW



vetro fumè (opz.NUFM)
smoked glass (opt.NUFM)

Neck

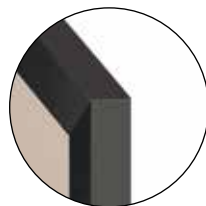

particolare anta squadrata
squared edge door detail

SP. 22 MM TH. 22 MM

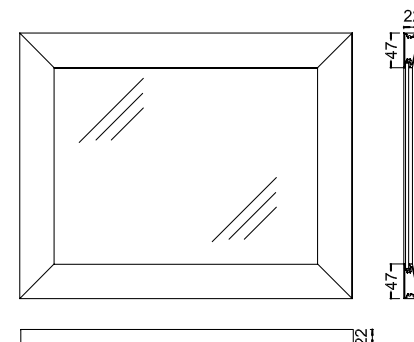

abbinabile alle versioni: G50-G51-G52-G53-G54

matched with versions: G50-G51-G52-G53-G54

a richiesta: telaio alluminio sp.22 mm finitura urban ossidato con pannello in lamiera stirata in alluminio effetto rete anodizzata nera (opz.NUR)

on request: 22 mm th. aluminium frame with urban oxidized finish and aluminium stretched metal sheet panel with black anodised mesh effect (opt.NUR)

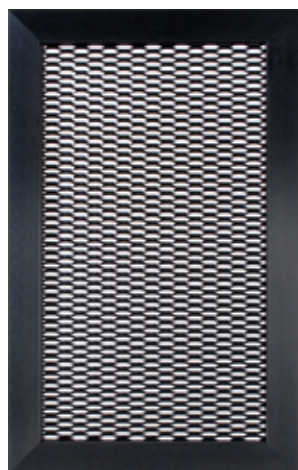

Neck

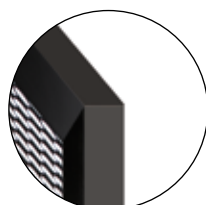

particolare anta squadrata
squared edge door detail

SP. 22 MM TH. 22 MM

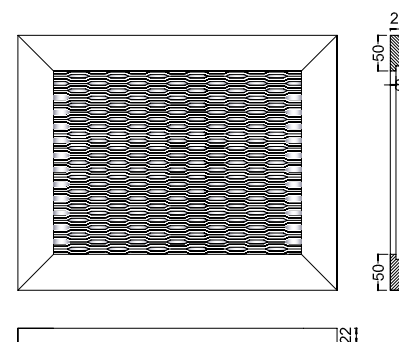

a richiesta: telaio alluminio sp.22 mm finitura urban ossidato con pannello in mdf idro placcato 2 lati in laminato lavagna nero (opz.NUL)

on request: 22 mm th. aluminium frame with urban oxidized finish, with idro mdf plated with blackboard laminate on both sides (opt.NUL)



Neck

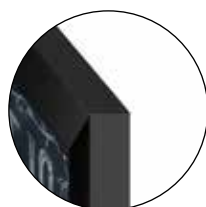

particolare anta squadrata
squared edge door detail

SP. 22 MM TH. 22 MM

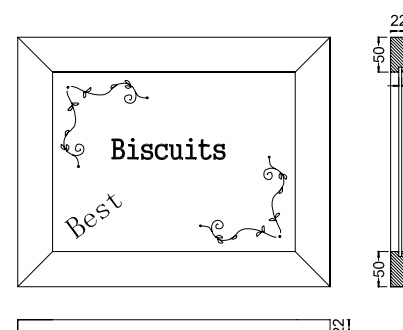

SP. 22 MM

OLTRE

Neck
Lux

CARATTERISTICHE TECNICHE

ANTE E FRONTALI CASSETTI

telaio alluminio sp.22 mm verniciato a polvere finitura opaca in tinta con il vetro, tamburato nella parte posteriore con pannello in HDF grigio cenere sp.3 mm.

Vetro temperato satinato sp.4 mm laccato nei colori **freddi**:
bianco assoluto (opz.V740S), cenere (opz.V9547), grigio bromo (opz.V9533), nero (opz.V7892)

Vetro temperato satinato sp.4 mm laccato nei colori **caldi**:
bianco caldo (opz.V7401), canapa (opz.V8531), castoro (opz.V8907), fumo (opz.V9531), verde lichene (opz.V8463), bistro (opz.V9535), rosso toscano (opz.V8157), giallo ambra (opz.V327S), grigio piombo (opz.V9537), verde positano (opz.V8471), bronzo (opz.V8903)

VERSIONE **NECK**

anta squadrata, per gola ad "ELLE"



VERSIONE **LUX** PROFILI E GOLE

di serie: anta profilo inclinata per gola ad "ELLE"
a richiesta: anta profilo inclinata per gola piatta

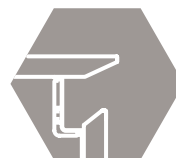

STRUTTURE

di serie: nobilitato bianco (opz.001) schiena e ripiano bianco (opz.001)

a richiesta: nobilitato visone (opz.948M) schiena e ripiano visone (opz.948M)
nobilitato lavagna (opz.9620) schiena e ripiano lavagna (opz.9620)
nobilitato perla d'oriente (opz.940) schiena e ripiano bianco (opz.001)
nobilitato fango (opz.8860) schiena e ripiano fango (opz.8860)
nobilitato conchiglia (opz.8910) schiena e ripiano conchiglia (opz.8910)
nobilitato argilla (opz.9690) schiena e ripiano argilla (opz.9690)



MENSOLE

di serie: altezza cm 3,8 in laminato come strutture: bianco (opz.001), perla d'oriente (opz.940), visone (opz.948M), lavagna (opz.9620), fango (opz.8860), argilla (opz.9690), conchiglia (opz.8910)

a richiesta: altezza cm 3,8 laccate opache finitura come ante laccate

ZOCCOLI

vedi pag.49



SP. 22 MM

OLTRE **N**eck **L**UX

CARATTERISTICHE TECNICHE

ANTE E FRONTALI CASSETTI

telaio alluminio sp.22 mm verniciato a polvere finitura opaca in tinta con il vetro, tamburato nella parte posteriore con pannello in HDF grigio cenere sp.3 mm.

Vetro temperato lucido sp.4 mm laccato nei colori **freddi**: bianco assoluto (opz.V741), cenere (opz.V9548), grigio bromo (opz.V9534), nero (opz.V7893)

Vetro temperato lucido sp.4 mm laccato nei colori **caldi**: bianco caldo (opz.V7402), canapa (opz.V8532), castoro (opz.V8908), fumo (opz.V9532), verde lichene (opz.V8464), bistro (opz.V9536), rosso toscano (opz.V8158), giallo ambra (opz.V328), grigio piombo (opz.V9538), verde positano (opz.V8472), bronzo (opz.V8904)

VERSIONE **NECK**

anta squadrata, per gola ad "ELLE"

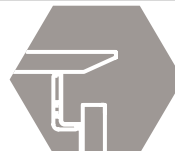

VERSIONE **LUX** PROFILI E GOLE

di serie: anta profilo inclinata per gola ad "ELLE"
a richiesta: anta profilo inclinata per gola piatta

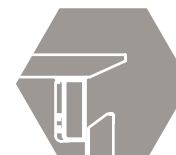
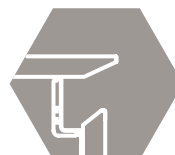

STRUTTURE

di serie: nobilitato bianco (opz.001) schiena e ripiano bianco (opz.001)

a richiesta: nobilitato visone (opz.948M) schiena e ripiano visone (opz.948M)
nobilitato lavagna (opz.9620) schiena e ripiano lavagna (opz.9620)
nobilitato perla d'oriente (opz.940) schiena e ripiano bianco (opz.001)
nobilitato fango (opz.8860) schiena e ripiano fango (opz.8860)
nobilitato conchiglia (opz.8910) schiena e ripiano conchiglia (opz.8910)
nobilitato argilla (opz.9690) schiena e ripiano argilla (opz.9690)



MENSOLE

di serie: altezza cm 3,8 in laminato come strutture: bianco (opz.001), perla d'oriente (opz.940), visone (opz.948M), lavagna (opz.9620), fango (opz.8860), argilla (opz.9690), conchiglia (opz.8910)

a richiesta: altezza cm 3,8 laccate lucide finitura come ante laccate

ZOCCOLI

vedi pag.49



TH. 22 MM

OLTRE Neck
LUX

TECHNICAL FEATURES

DOORS AND DRAWER FRONTS

Aluminium frame Th.22 mm dust painted with matt finish matching with the glass and back coated with an HDF panel colour ash grey

Hardened satin glass, lacquered in the following **cold** colours:
absolute white (opt.V740S), ash (opt.V9547), bromine grey (opt.V9533), black (opt.V7892)

Hardened satin glass, lacquered in the following **hot** colours:
warm white (opt.V7401), hemp (opt.V8531), beaver (opt.V8907), smoke (opt.V9531), lichen green (opt.V8463), bistro (opt.V9535), tuscan red (opt.V8157), amber yellow (opt.V327S), lead grey (opt.V9537), positano green (opt.V8471), bronze (opt.V8903)

NECK VERSION

square edge door, for "L-SHAPED" finger rail



PROFILES AND FINGER RAILS LUX VERSION **standard:** inclined edge door, for "L-SHAPED" finger rail
on request: inclined edge door, for flat finger rail

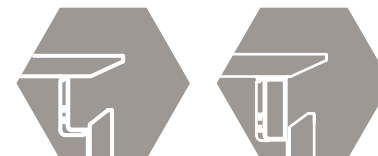

STRUCTURES

standard: melamine-coated white (opt.001), white back panel and shelf (opt.001)

on request: melamine-coated mink (opt.948M), mink back panel and shelf (opt.948M)
melamine-coated slate grey (opt.9620), slate grey back panel and shelf (opt.9620)
melamine-coated oriental pearl (opt.940), white back panel and shelf (opt.001)
melamine-coated mud (opt.8860), mud back panel and shelf (opt.8860)
melamine-coated shell (opt.8910), shell back panel and shelf (opt.8910)
melamine-coated clay (opt.9690), clay back panel and shelf (opt.9690)

SHELVES

standard: : height 3.8 cm, in laminate to match structure: white (opt.001) oriental pearl (opt.940), mink (opt.948M), slate grey (opt.9620), mud (opt.8860), clay (opt.9690), shell (opt.8910)

on request: height 3.8 cm, matt lacquered same finish as laquered doors

PLINTHS

see page 49

TH. 22 MM

OLTRE **N**eck
LUX

TECHNICAL FEATURES

**DOORS AND
DRAWER FRONTS**

aluminium frame Th.22 mm dust painted with matt finish matching with the glass and back coated with an HDF panel colour ash grey

Hardened glossy glass, lacquered in the following **cold** colours:
absolute white (opt.V741), ash (opt.V9548), bromine grey (opt.V9534), black (opt.V7893)

Hardened glossy glass, lacquered in the following **hot** colours:
warm white (opt.V7402), hemp (opt.V8532), beaver (opt.V8908), smoke (opt.V9532), lichen green (opt.V8464), bistro (opt.V9536), tuscan red (opt.V8158), amber yellow (opt.V328), lead grey (opt.V9538), positano green (opt.V8472), bronze (opt.V8904)

NECK VERSION

square edge door, for "L-SHAPED" finger rail

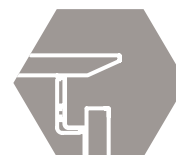

**PROFILES AND FINGER
RAILS LUX VERSION**

standard: inclined edge door, for "L-SHAPED" finger rail
on request: inclined edge door, for flat finger rail

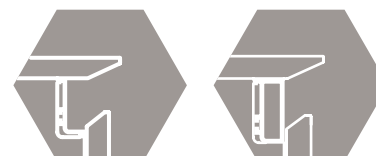

STRUCTURES

standard: melamine-coated white (opt.001), white back panel and shelf (opt.001)

on request: melamine-coated mink (opt.948M), mink back panel and shelf (opt.948M)
melamine-coated slate grey (opt.9620), slate grey back panel and shelf (opt.9620)
melamine-coated oriental pearl (opt.940), white back panel and shelf (opt.001)
melamine-coated mud (opt.8860), mud back panel and shelf (opt.8860)
melamine-coated shell (opt.8910), shell back panel and shelf (opt.8910)
melamine-coated clay (opt.9690), clay back panel and shelf (opt.9690)

SHELVES

standard: : height 3.8 cm, in laminate to match structure: white (opt.001) oriental pearl (opt.940), mink (opt.948M), slate grey (opt.9620), mud (opt.8860), clay (opt.9690), shell (opt.8910)

on request: height 3.8 cm, glossy lacquered same finish as lacquered doors

PLINTHS

see page 49

OLTRE **N**eck
LUX

SP. 22 MM TH. 22 MM

anta vetro satinato
satin glass door



telaio alluminio, vetro fumo (opz.V9531)
aluminum frame, smoke glass (opt.V9531)



particolare retro anta grigio cenere
detail of the back side of the door,
ash grey colour

Neck

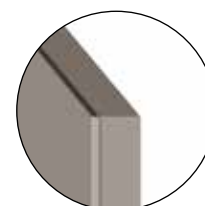

particolare anta squadrata
squared edge door detail

COLORI FREDDI SATINATI SATIN COLD COLOURS



bianco assoluto
satinato (opz.V740S)
satin absolute white

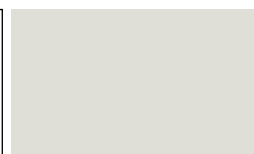

cenere satinato
(opz.V9547)
satin ash



grigio bromo satinato
(opz.V9533)
satin bromine grey



nero satinato
(opz.V7892)
satin black

LUX

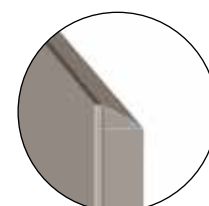

particolare anta inclinata
inclined edge door detail

COLORI CALDI SATINATI SATIN HOT COLOURS

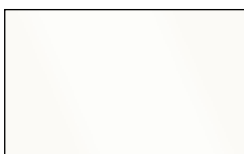

bianco caldo satinato
(opz.V7401)
satin warm white



canapa satinato
(opz.V8531)
satin hemp



castoro satinato
(opz.V8907)
satin beaver



fumo satinato
(opz.V9531)
satin smoke



verde lichene satinato
(opz.V8463)
satin lichen green



bistro satinato
(opz.V9535)
satin bistro



rosso toscano satinato
(opz.V8157)
satin tuscan red



giallo ambra satinato
(opz.V327S)
satin amber yellow



grigio piombo satinato
(opz.V9537)
satin lead grey



verde positano satinato
(opz.V8471)
satin positano green



bronzo satinato
(opz.V8903)
satin bronze

SP. 22 MM TH. 22 MM

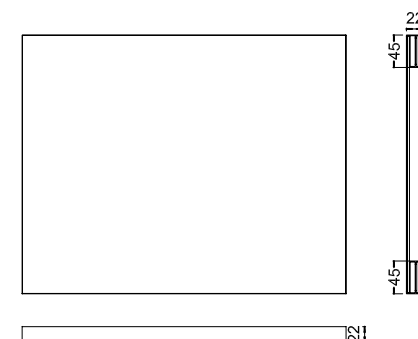

cod. **G56** Neck **G66** Lux

Vetro Lucido
Glossy Glass

OLTRE **N**eck
Lux

SP. 22 MM TH. 22 MM

anta vetro lucido
glossy glass doors



telaio alluminio, vetro fumo (opz.V9532)
aluminum frame, smoke glass (opt.V9532)



particolare retro anta grigio cenere
detail of the back side of the door,
ash grey colour

COLORI FREDDI LUCIDO GLOSSY COLD COLOURS



bianco assoluto lucido (opz.V741) glossy absolute white
cenere lucido (opz.V9548) glossy ash
grigio bromo lucido (opz.V9534) glossy bromine grey
nero lucido (opz.V7893) glossy black

COLORI CALDI LUCIDO GLOSSY HOT COLOURS



bianco caldo lucido (opz.V7402) glossy warm white
canapa lucido (opz.V8532) glossy hemp
castoro lucido (opz.V8908) glossy beaver
fumo lucido (opz.V9532) glossy smoke

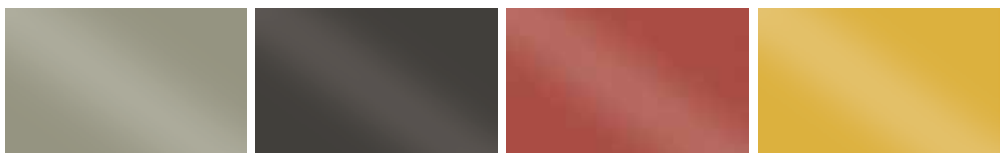

verde lichene lucido (opz.V8464) glossy lichen green
bistro lucido (opz.V9536) glossy bistro
rosso toscano lucido (opz.V8158) glossy tuscan red
giallo ambra lucido (opz.V328) glossy amber yellow



grigio piombo lucido (opz.V9538) glossy lead grey
verde positano lucido (opz.V8472) glossy positano green
bronzio lucido (opz.V8904) glossy bronze

Neck

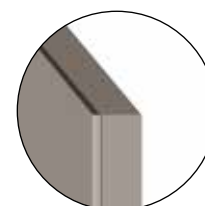

particolare anta squadrata
squared edge door detail

Lux

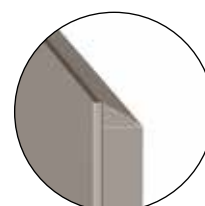

particolare anta inclinata
inclined edge door detail

SP. 22 MM TH. 22 MM

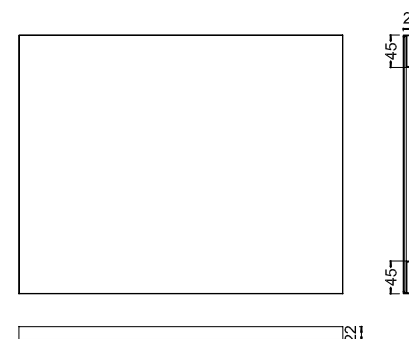

strutture carcasses

NEW

NEW



bianco (opz.001)
schiena e ripiano bianco
(opz.001)
white (opt.001)
white back panel and shelf
(opt.001)



perla d'oriente (opz.940)
schiena e ripiano bianco
(opz.001)
oriental pearl (opt.940)
white back panel and shelf
(opt.001)



conchiglia (opz.8910)
schiena e ripiano conchiglia
(opz.8910)
shell (opt.8910)
shell back panel and shelf
(opt.8910)



argilla (opz.9690)
schiena e ripiano argilla
(opz.9690)
clay (opt.9690)
clay back panel and shelf
(opt.9690)



lavagna (opz.9620)
schiena e ripiano lavagna
(opz.9620)
slate grey (opt.9620)
slate grey back panel
and shelf (opt.9620)



fango (opz.8860)
schiena e ripiano fango
(opz.8860)
mud (opt.8860)
mud back panel and
shelf (opt.8860)



visone (opz.948M)
schiena e ripiano visone
(opz.948M)
mink (opt.948M)
mink back panel and shelf
(opt.948M)



LUBE ECOLOGIC

IL GRUPPO LUBE HA SCELTO DI UTILIZZARE PER I COMPONENTI COSTITUENTI LE STRUTTURE DELLE CUCINE SOLO MATERIALE A BASSISSIMA EMISSIONE DI FORMALDEIDE: CONFORMI ALLO STANDARD F**** SECONDO LA NORMA JIS, CERTIFICATO DAL MINISTERO GIAPPONESE, IL PIU' SEVERO IN MERITO ALLE NORMATIVE DI SALVAGUARDIA AMBIENTALE.

LUBE GROUP HAS CHOSEN TO EXCLUSIVELY USE MATERIALS WITH VERY LOW FORMALDEHYDE EMISSIONS FOR THE COMPONENTS MAKING UP THE KITCHEN CARCASSES: THESE ELEMENTS COMPLY WITH THE F4 STAR STANDARD ACCORDING TO JIS, CERTIFIED BY THE JAPANESE GOVERNMENT - THE MOST STRINGENT WHEN IT COMES TO ENVIRONMENTAL PROTECTION.

mensole in laminato P 31-61 come strutture same colours as carcasses laminated shelves D 31-61



bianco (opz.001)
white (opt.001)



perla d'oriente (opz.940)
oriental pearl (opt.940)

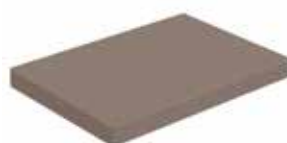

fango (opz.8860)
mud (opt.8860)



visone (opz.948M)
mink (opt.948M)



lavagna (opz.9620)
slate grey (opt.9620)

NEW

NEW



argilla (opz.9690)
clay (opt.9690)



conchiglia (opz.8910)
shell (opt.8910)

mensole impialacciate veneered shelves



impialacciata come anta
N.B.: per le finiture vedi pagina 20
veneered same finish as door
Note: for the finishes see page 20

mensole fenix fenix shelves

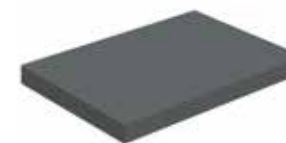

fenix come anta
N.B.: per le finiture vedi pagina 24
fenix as door
Note: for the finishes see page 24

mensole laccate lacquered shelves

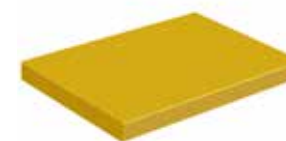

laccate opache e lucide come anta
N.B.: per le finiture vedi pagine 34-35
matt and glossy lacquered as door
Note: for the finishes see pages 34-35

mensole laccate vintage vintage lacquered shelves



laccate vintage come anta
N.B.: per le finiture vedi pagina 38
vintage lacquered as door
Note: for the finishes see page 38

zoccoli in alluminio H 6 aluminium plinth H 6

di serie
standard



alluminio finitura titanio
ossidato (opz.414)
aluminium titanium
oxidized finish (opt.414)

**N.B.: ABBINAMENTO CONSIGLIATO
CON L'ANTA BRONZO BRUNITO
NOTE: BEST MATCHING WITH THE
BURNISHED BRONZE DOOR**

zoccoli in alluminio H 6 aluminium plinth H 6

a richiesta
on request



alluminio finitura urban
ossidato (opz.NU)
aluminium urban
oxidized finish (opt.NU)



alluminio
finitura brill (opz.412)
aluminium
brill finish (opt.412)

NEW



alluminio finitura rame
anticato (opz.422)
aluminium antique
copper finish
(opt.422)

NEW



alluminio finitura
grafite (opz.421)
aluminium graphite
finish (opt.421)

NEW



alluminio finitura nichel
(opz.420)
aluminium nickel
finish (opt.420)

NEW



alluminio finitura
bronzo anticato
(opz.423)
aluminium antique
bronze finish (opt.423)

zoccoli in alluminio H 6 verniciati a polvere finitura opaca aluminum plinth height H 6 powder coated matt finish



alluminio finitura nero
(opz.7892)
aluminium
black finish (opt.7892)



alluminio finitura fumo
(opz.9531)
aluminium
smoke finish
(opt.9531)



alluminio finitura
bianco caldo (opz.7401)
aluminium warm white
finish (opt.7401)



alluminio finitura
bianco assoluto (opz.740S)
aluminium absolute
white finish (opt.740S)



alluminio finitura
verde positano
(opz.8471)
aluminium positano
green finish (opt.8471)



alluminio finitura
acquamarina
(opz.8323)
aluminium
aquamarine finish
(opt.8323)



alluminio finitura
castoro (opz.8907)
aluminium beaver
finish (opt.8907)



alluminio finitura rosso
toscano (opz.8157)
aluminium tuscan red
finish (opt.8157)



alluminio finitura grigio
bromo (opz.9533)
aluminium bromine
grey finish (opt.9533)



alluminio finitura
silver dark (opz.9507)
aluminium dark silver
finish (opt.9507)



alluminio finitura
argilla (opz.9503)
aluminium clay
finish (opt.9503)



alluminio finitura
conchiglia (opz.7403)
aluminium shell
finish (opt.7403)



alluminio finitura
ghisa (opz.9509)
aluminium cast iron
finish (opt.9509)



alluminio bistro
(opz.9535)
aluminium bistro
finish (opt.9535)



alluminio finitura
grigio selce (opz.SE)
aluminium flint grey
finish (opt.SE)

MECCANISMI MOTORIZZATI SERVO-DRIVE

SERVO-DRIVE MOTORISED
MECHANISMS

Estrema facilità di apertura e chiusura ante
Extreme ease in opening and closing the doors

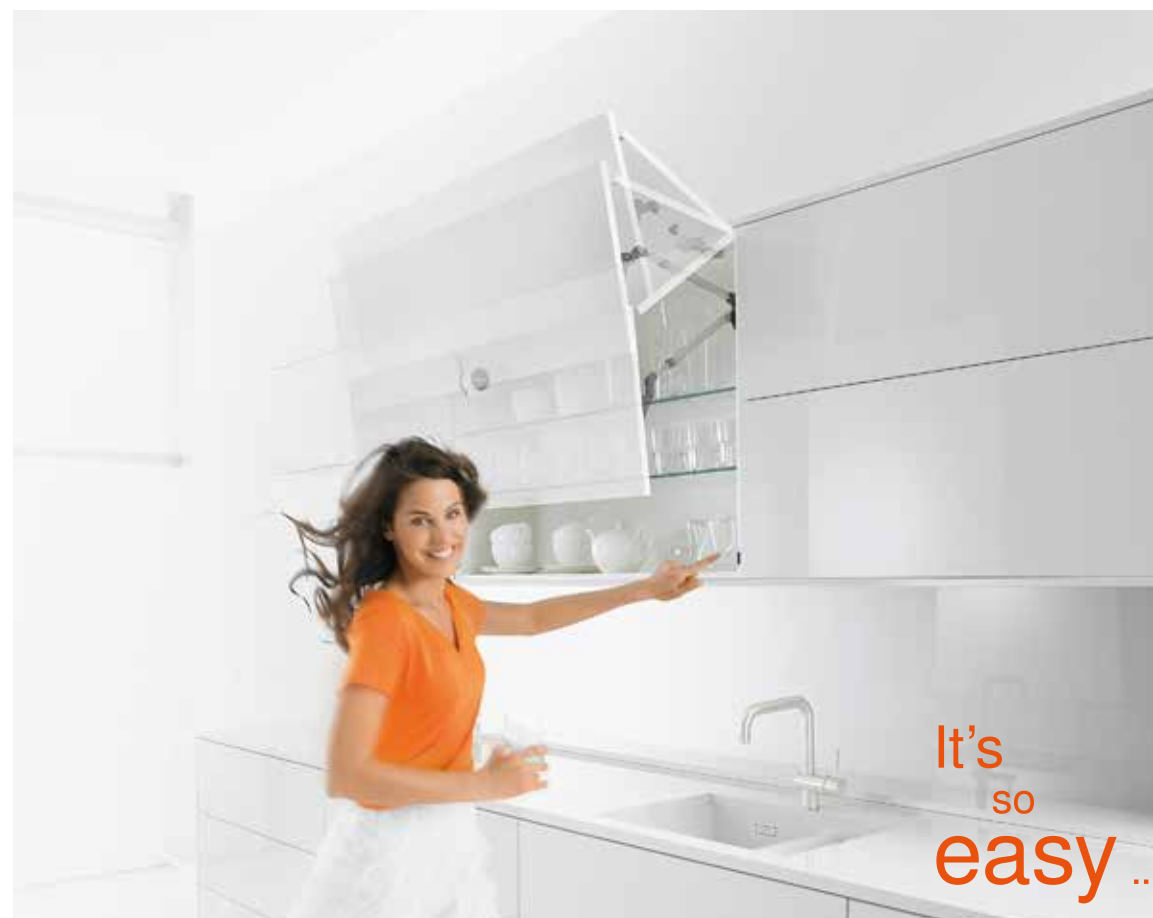

OLTRE

N.B.: il SERVO-DRIVE non può essere installato successivamente ma deve essere richiesto contemporaneamente all'ordine del pensile. Motorizzato SERVO-DRIVE (Opz.007)

NOTE: SERVO-DRIVE cannot be installed at a later date but must be ordered at the same time with the wall unit. SERVO-DRIVE motorised (Opt.007)

APERTURA ANTE A PACCHETTO
LIFT-UP FOLDING DOOR OPENING



APERTURA VERTICALE OBLIQUA
OBLIQUE VERTICAL OPENING



APERTURA RIBALTA
FLAPDOOR OPENING



APERTURA VERTICALE
VERTICAL OPENING



ESTREMAMENTE FACILE DA UTILIZZARE

EXTREMELY EASY TO USE

OLTRE



Grazie a SERVO-DRIVE basta una leggera pressione sul fronte con la mano o il gomito per aprire automaticamente le ante a ribalta.

Persino i frontali grandi e pesanti si aprono verso l'alto come in totale assenza di gravità. Inoltre, l'utilizzatore della cucina può godere di un accesso ottimale all'interno del mobile.

Thanks to SERVO-DRIVE, just apply light pressure to the front panel with the hand or elbow to automatically open the folding doors.

Even large front panels open upwards with a complete lack of gravity. In addition, the opening provides optimum access to the cabinet interior.



Chiusura comoda e semplice, assicurata dall'interruttore facilmente raggiungibile, montato sul fianco del corpo mobile.

Le chiusure delle ante a ribalta risulta così estremamente comoda ed ergonomica, mentre la rinomata funzione BLUMOTION garantisce una chiusura dolce e silenziosa.

Simple and comfortable closure by using an easy-to-reach switch fitted on the side of the cabinet.

Closing the folding doors is so easy, comfortable and ergonomic. The renowned BLUMOTION function also ensures gentle and silent closing.



KIT TRASFORMATORE

POWER SUPPLY KIT

OLTRE

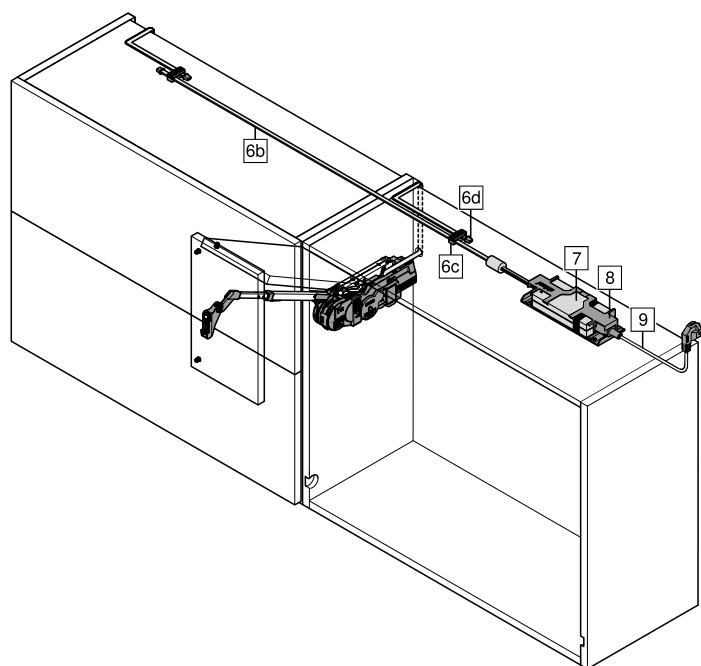

Kit trasformatore composto da:
Power supply kit includes:

- 6b** Cavo di distribuzione lunghezza 8 mt
Power supply cable length 8 m
 - 6c** 1 Connettore
Connector
 - 6d** Protezione estremità cavo
Cable end protection
 - 7** Trasformatore universale per tutti paesi del mondo
72 W completo di supporto per il montaggio
Universal power supply worldwide,
72 W complete with mounting bracket
 - 8** Supporto trasformatore
Power supply mounting bracket
 - 9** Cavo di alimentazione elettrica UE
EU electrical power supply cable
- i** Per ogni cavo di distribuzione può essere collegato un solo trasformatore Blum.
Only one Blum power supply may be connected to each power supply cable.

Per il meccanismo elettrico motorizzato SERVO-DRIVE richiedere sempre il kit trasformatore, codice 5615850 -
Un trasformatore può alimentare fino a 10 motori.

N.B.: si potrebbero verificare situazioni dove occorre utilizzare più di un kit trasformatore.

For the motorised electric SERVO-DRIVE mechanism, always request the power supply kit: code 5615850 -

One power supply can power up to 10 motors.

NOTE: in some cases one may use more than one power supply kit.

PENSILI SU PARETI CONTINUE

CONTINUOUS WALL UNITS

COMPOSIZIONE "A"

COMPOSITION "A"

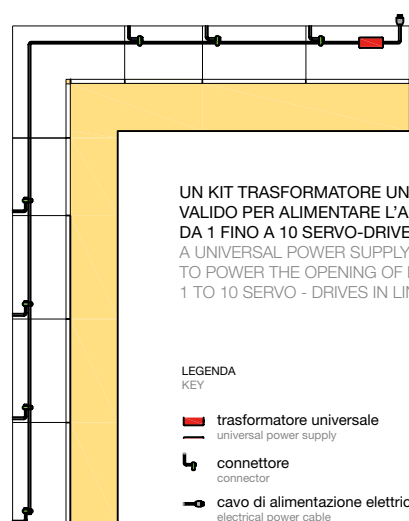

PENSILI SU PARETI SEPARATE

SEPARATE WALL UNITS

COMPOSIZIONE "B"

COMPOSITION "B"

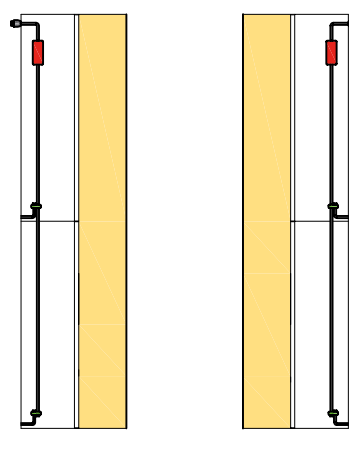

APERTURA VERTICALE OBLIQUA

I pensili con questo tipo di meccanismo necessitano per l'apertura di poco spazio libero sopra il mobile grazie al movimento basculante dell'anta che si apre senza difficoltà applicando poca forza anche in presenza di frontali pesanti. Con l'arresto progressivo le ante si fermano in qualsiasi posizione; in questo modo la maniglia è sempre facilmente raggiungibile. La chiusura è ammortizzata ed è possibile regolare la forza di tenuta in base al peso del frontale.

VERTICAL OPENING OBLIQUE

Wall units that mount this type of mechanism require little clearance above the cabinet thanks to the swivelling movement of the door that can be easily opened by applying slight pressure, even with heavy fronts. The doors stop in any position thanks to the gradual stopping movement; in this way, the handle is always easily accessible. The closing movement is cushioned and the closing force can be adjusted according to the weight of the front door.



**DI SERIE
STANDARD**

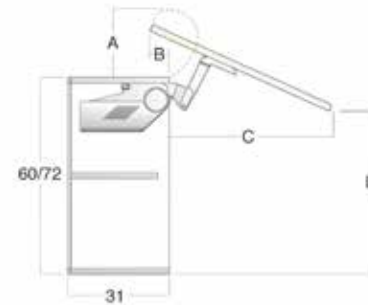

**MOTORIZZATO
SERVO-DRIVE
SERVO-DRIVE
MOTORISED
(Opz.007)**

	A	B	C	D
H 60	18	9,6	46,5	53,5
H 72	18	9,6	57	61

APERTURA VERTICALE

L'anta ad apertura verticale, potendo essere sollevata completamente verso l'alto, consente un accesso totale all'interno del pensile. Ideale per l'impiego in mobili a colonna per nascondere ad esempio apparecchi elettrici, o pensili con corpi mobili sovrastanti, ha la chiusura ammortizzata e la possibilità di regolare la forza di tenuta in base al peso del frontale.

VERTICAL OPENING

Doors with vertical opening movement can be fully raised to fully access the inside of the wall unit.

Ideal for use on column units to conceal electrical appliances for examples, or on wall units surmounted by mobile units.

The closing movement is cushioned and the closing force can be adjusted according to the weight of the front door.



**DI SERIE
STANDARD**



**MOTORIZZATO
SERVO-DRIVE
SERVO-DRIVE
MOTORISED
(Opz.007)**

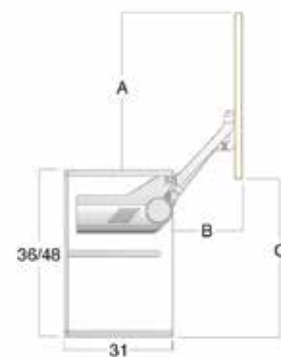

	A	B	C	
H 36	34	23,5	34,5	
H 48	43	28,5	43,5	

PENSILE CON APERTURA ANTE A PACCHETTO

Il meccanismo d'apertura ante a pacchetto è idoneo sul pensile H 72; la regolazione della forza di apertura può essere impostata in modo esatto in base ai pesi dei frontali, la chiusura è ammortizzata e la cerniera centrale clip si contraddistingue per l'innovativa tecnologia che garantisce la sicurezza per le dita.

WALL UNIT WITH LIFT-UP FOLDING DOORS

The lift-up folding door opening mechanism is suitable for wall units with H 72; the opening force can be adjusted precisely according to the weight of the fronts, while the closing movement is cushioned and the central clip-on hinge features innovative technology for safeguarding the fingers.



**DI SERIE
STANDARD**



**MOTORIZZATO
SERVO-DRIVE
SERVO-DRIVE
MOTORISED**

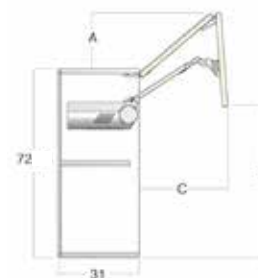

	A	B	C	
H 72	16,5	54	41	

**SCHEMA MONTAGGIO
LIMITATORE
LIMITER INSTALLATION
DIAGRAM**

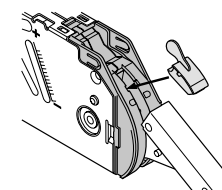

Per evitare l'interferenza dell'anta in fase di apertura con cornici o mensole, si può richiedere il limitatore dell'angolo di apertura cod. 5620005

In order to avoid that the door interferes with cornices or shelves during the opening movement, it is possible to request an opening angle limiter: code 5620005

PENSILE CON APERTURA A RIBALTA

Le ante aprendosi verso l'alto consentono di avere un' ampia visione d'insieme all'interno del mobile. In questo modo è possibile un comodo accesso agli oggetti contenuti al suo interno e, dal punto di vista ergonomico, molto vantaggioso. La regolazione della forza di apertura può essere impostata in modo esatto in base al peso del frontale. Grazie all'arresto progressivo le ante si fermano in qualsiasi posizione; in questo modo la maniglia è sempre facilmente raggiungibile. La chiusura è ammortizzata e un'unica manovra è sufficiente per regolare il frontale tridimensionalmente grazie all'assenza di cerniere e al sistema di aggancio clip.

WALL UNIT WITH FLAP DOOR

The doors that open upwards guarantee ample overall visibility inside the cabinet. In this way, all objects housed inside the cabinet can be comfortably accessed, making the system highly advantageous from an ergonomic perspective. The opening force can be adjusted precisely according to the weight of the front. The doors stop in any position thanks to the gradual stopping movement; in this way, the handle is always easily accessible. The closing movement is cushioned and a single manoeuvre is required to three-dimensionally adjust the front, thanks to the clip-on system and the absence of hinges.



DI SERIE STANDARD

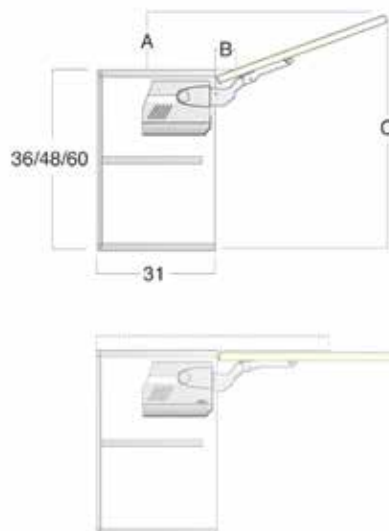

	A	B	C
H 36	11,5	3,5	37
H 48	15	3,5	49
H 60	18,5	3,5	61

MOTORIZZATO SERVO-DRIVE SERVO-DRIVE MOTORISED (Opz.007)



SCHEMA MONTAGGIO LIMITATORE PER RIBALTA H 36 FLAP DOOR LIMITER INSTALLATION DIAGRAM H 36

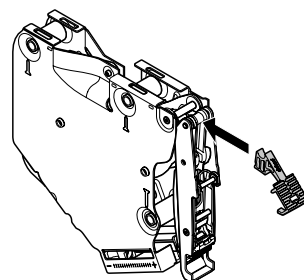

Per evitare l'interferenza dell'anta in fase di apertura con cornici o mensole, si può richiedere il limitatore dell'angolo di apertura cod. 5620010

In order to avoid that the door interferes with cornices or shelves during the opening movement, it is possible to request an opening angle limiter: code 5620010

SCHEMA MONTAGGIO LIMITATORE PER RIBALTA H 48 FLAP DOOR LIMITER INSTALLATION DIAGRAM H 48

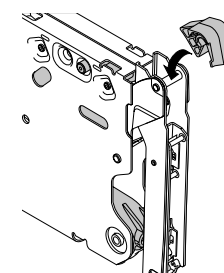

COLONNE ARMADIO “NOOK” H 222 P 70,4 CON ANTE RIENTRANTI

“NOOK” CLOSET COLUMNS H 222 D 70,4 WITH DOORS INWARDS

Le colonne armadio “Nook” con ante a scomparsa, consentono di inserire all’interno forno, frigo, tavolo e cassetti

“Nook” closet columns with pull-out doors allow to insert oven, fridge, table and drawer on the inside



COLONNE ARMADIO “NOOK” H 222 P 70,4 CON ANTE RIENTRANTI

“NOOK” CLOSET COLUMNS H 222 D 70,4 WITH DOORS INWARDS

Il tavolo estraibile è disponibile nella versione inox o in laminato, nella finitura oak cognac

The pull-out table it's available in stainless steel version or laminate oak cognac finish



LA COLLEZIONE BRIDGE DEL PROGRAMMA
OLTRE PRESENTA UNA GRANDE VARIETA' DI
MANIGLIE, DI VARIE FORME,
MATERIALI, DIMENSIONI E FINITURE,
CREATE AD HOC PER DARE UNICITA'
E PERSONALITA' AD OGNI CUCINA.

THE BRIDGE COLLECTION OF OLTRE PROGRAM PROPOSE A WIDE
RANGE OF HANDLES, IN VARIOUS FORMS,
MATERIALS, DIMENSIONS AND FINISHES,
SPECIFICALLY CREATED TO GIVE UNIQUENESS AND PERSONALITY
TO EACH KITCHEN.

OLTRE

Bridge



FRONTALE
anta con maniglia frontale
door with front handle



IN TESTA
anta con maniglia in testa
door with top mounted handle



FUSION
anta con maniglia integrata
door with built-in handle

ANTA SQUADRATA
CON MANIGLIA
SQUARE DOOR WITH HANDLE



I MODELLI BRIDGE POSSONO ESSERE REALIZZATI ANCHE SENZA MANIGLIA CON DIVERSE TIPOLOGIE DI APERTURE.

BRIDGE MODELS CAN BE REALIZED ALSO WITHOUT HANDLE AND SEVERAL TYPES OF OPENINGS.

PENSILI APERTURA PRESA SU FONDO WALL UNITS WITH GRIP ON BOTTOM OPENING



PARTICOLARE PRESA SU FONDO
DETAIL WITH GRIP ON BOTTOM

ANTA PUSH-PULL PER BASI E COLONNE PUSH-PULL DOOR FOR BASE UNITS AND COLUMNS

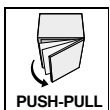

MECCANISMO PUSH-PULL
PUSH-PULL MACHNISM

CASSETTO E CESTONE TIP-ON DRAWER AND DEEP DRAWER TIP-ON

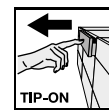

MECCANISMO TIP-ON
TIP-ON MACHNISM

LAVASTOVIGLIE CON SERVO-DRIVE FLEX DISHWASHER WITH FLEX SERVO-DRIVE



MECCANISMO SERVO-DRIVE
SERVO-DRIVE MACHNISM

FRIGO CON SERVO-DRIVE FLEX FRIDGE WITH FLEX SERVO-DRIVE



MECCANISMO SERVO-DRIVE
SERVO-DRIVE MACHNISM

CARATTERISTICHE TECNICHE**ANTE E FRONTALI
CASSETTI**

anta sp.22 mm impiallacciata **rovere vintage con nodi e stuccature venatura verticale finitura materica** nei colori: rovere bianco invecchiato (opz.5380), rovere juta invecchiato (opz.5381), rovere corteccia invecchiato (opz.5382), rovere mielato invecchiato (opz.5383), rovere antracite invecchiato (opz.5384), rovere argilla invecchiato (opz.5385), rovere moro invecchiato (opz.5386), rovere naturale invecchiato parquetato (opz.5387), rovere grigio terra (opz.5389), rovere madera termocotto con finto tarlo (opz.5388)

MANIGLIE

vedi pag.206-215

STRUTTURE**ANTE: rovere argilla invecchiato**

di serie : nobilitato bianco (opz.001) schiena e ripiano bianco (opz.001)

ANTE: rovere bianco invecchiato, rovere juta invecchiato

di serie : nobilitato visone (opz.948M) schiena e ripiano visone (opz.948M)

ANTE: rovere antracite invecchiato

di serie : nobilitato lavagna (opz.9620) schiena e ripiano lavagna (opz.9620)

ANTE: rovere corteccia invecchiato, rovere mielato invecchiato, rovere moro invecchiato, rovere naturale parquetato, rovere madera termocotto, rovere grigio terra

di serie : nobilitato fango (opz.8860) schiena e ripiano fango (opz.8860)

a richiesta : nobilitato perla d'oriente (opz.940) schiena e ripiano bianco (opz.001)
nobilitato conchiglia (opz.8910) schiena e ripiano conchiglia (opz.8910)
nobilitato argilla (opz.9690) schiena e ripiano argilla (opz.9690)

**MENSOLE**

di serie: altezza cm 3,8 in laminato come strutture: bianco (opz.001), perla d'oriente (opz.940), visone (opz.948M), lavagna (opz.9620), fango (opz.8860), argilla (opz.9690), conchiglia (opz.8910)

a richiesta: altezza cm 3,8 impiallacciata finiture come ante

ZOCCOLI

vedi pag.221



TH. 22 MM

OLTRE Bridge**TECHNICAL FEATURES****DOORS AND
DRAWER FRONTS**

22 mm th. veneered door **vintage oak with knots and filler vertical grain textured finish** in the following colours:
white aged oak (opt.5380), jute aged oak (opt.5381), bark aged oak (opt.5382), honey aged oak (opt.5383),
anthracite aged oak (opt.5384), clay aged oak (opt.5385), dark aged oak (opt.5386), parquet-effect natural aged oak (opt.5387)
grey earth oak (opt.5389), heat treated madera oak with worm-eaten effect (opt.5388)

HANDLES

[see page 206-215](#)

STRUCTURES**DOORS: clay aged oak**

standard: melamine-coated white (opt.001), white back panel and shelf (opt.001)

DOORS: white aged oak, jute aged oak

standard: melamine-coated mink (opt.948M), mink back panel and shelf (opt.948M)

DOORS: anthracite aged oak

standard: melamine-coated slate grey (opt.9620), slate grey back panel and shelf (opt.9620)

DOORS: bark aged oak, honey aged oak, dark aged oak, parquet-effect natural aged oak, heat treated madera oak, grey earth oak

standard: melamine-coated mud (opt.8860), mud back panel and shelf (opt.8860)

on request: melamine-coated oriental pearl (opt.940), white back panel and shelf (opt.001)

melamine-coated shell (opt.8910), shell back panel and shelf (opt.8910)

melamine-coated clay (opt.9690), clay back panel and shelf (opt.9690)

SHELVES

standard: height 3.8 cm, in laminate to match structure: white (opt.001), oriental pearl (opt.940),
mink (opt.948M), slate grey (opt.9620), mud (opt.8860), clay (opt.9690), shell (opt.8910)

on request: height 3.8 cm, veneered to match doors

PLINTHS

[see page 221](#)

SP. 22 MM TH. 22 MM

anta finitura materica vintage
door with textured vintage finish



rovere bianco invecchiato
(opz.5380)
white aged oak (opt.5380)



rovere juta invecchiato
(opz.5381)
jute aged oak (opt.5381)



rovere corteccia invecchiato
(opz.5382)
bark aged oak (opt.5382)



rovere mielato invecchiato
(opz.5383)
honey aged oak (opt.5383)



rovere antracite invecchiato
(opz.5384)
anthracite aged oak
(opt.5384)



rovere argilla invecchiato
(opz.5385)
clay aged oak (opt.5385)



rovere moro invecchiato
(opz.5386)
dark aged oak (opt.5386)



rovere naturale invecchiato
parquettato (opz.5387)
parquet-effect natural aged
oak (opt.5387)



rovere mader termocotto
con finto tarlo (opz.5388)
heat treated mader oak with
worm-eaten effect (opt.5388)



particolare anta con finto tarlo
door with worm-eaten effect detail



rovere grigio terra (opz.5389)
grey earth oak (opt.5389)



SP. 22 MM

OLTRE Bridge**CARATTERISTICHE TECNICHE****ANTE E FRONTALI
CASSETTI**

anta sp.22 mm con pannello in truciolare E1 rivestito lato esterno con fenix spessore 9/10 lato interno in laminato spessore 9/10 in tinta come esterno, bordata in polipropilene con incollaggio laser spessore 10/10, nei colori:
bianco caldo (opz.7446), castoro (opz.8864), nero (opz.7861), grigio bromo (opz.9628), fumo (opz.9629), cacao orinoco (opz.8865), beige arizona (opz.7705), grigio efeso (opz.9630), blu fes (opz.8301), bianco dover (opz.7449)

MANIGLIE

vedi pag.206-215

STRUTTURE**ANTE: bianco caldo, bianco dover**

di serie : nobilitato bianco (opz.001) schiena e ripiano bianco (opz.001)

ANTE: fumo, beige arizona

di serie : nobilitato visone (opz.948M) schiena e ripiano visone (opz.948M)

ANTE: nero, grigio bromo, blu fes

di serie : nobilitato lavagna (opz.9620) schiena e ripiano lavagna (opz.9620)

ANTA: castoro

di serie : nobilitato conchiglia (opz.8910) schiena e ripiano conchiglia (opz.8910)

ANTA: cacao orinoco

nobilitato fango (opz.8860) schiena e ripiano fango (opz.8860)

ANTA: grigio efeso

nobilitato argilla (opz.9690) schiena e ripiano argilla (opz.9690)

a richiesta : nobilitato perla d'oriente (opz.940) schiena e ripiano bianco (opz.001)

MENSOLE

di serie: altezza cm 3,8 in laminato come strutture: bianco (opz.001), perla d'oriente (opz.940), visone (opz.948M), lavagna (opz.9620), fango (opz.8860), argilla (opz.9690), conchiglia (opz.8910)

a richiesta: altezza cm 3,8 finiture come ante

ZOCCOLI

vedi pag.221



TH. 22 MM

OLTRE Bridge**TECHNICAL FEATURES****DOORS AND
DRAWER FRONTS**

22 mm th. door with E1 chipboard panel with exterior coated in 9/10 thickness Fenix and interior in 9/10 thickness laminate in the same colour as the exterior. Edge in 10/10 thickness polypropylene with laser gluing, in the following colours:
warm white (opt.7446), beaver (opt.8864), black (opt.7861), bromine grey (opt.9628), smoke (opt.9629),
cocoa orinoco (opt.8865), arizona beige (opt.7705), ephesus grey (opt.9630), blue fes (opt.8301), dover white (opt.7449)

HANDLES

[see page 206-215](#)

STRUCTURES

DOORS: warm white, dover white
standard: melamine-coated white (opt.001), white back panel and shelf (opt.001)
DOORS: smoke, arizona beige
standard: melamine-coated mink (opt.948M), mink back panel and shelf (opt.948M)
DOORS: black, bromine grey, fles blue
standard: melamine-coated slate grey (opt.9620), slate grey back panel and shelf (opt.9620)
DOOR: beaver
standard: melamine-coated shell (opt.8910), shell back panel and shelf (opt.8910)
DOOR: orinoco cocoa
standard: melamine-coated mud (opt.8860), mud back panel and shelf (opt.8860)
DOOR: ephesus grey
standard: melamine-coated clay (opt.9690), clay back panel and shelf (opt.9690)

on request: melamine-coated oriental pearl (opt.940), white back panel and shelf (opt.001)

SHELVES

standard: height 3.8 cm, in laminate to match structure: white (opt.001) oriental pearl (opt.940),
mink (opt.948M), slate grey (opt.9620), mud (opt.8860), clay (opt.9690), shell (opt.8910)

on request: height 3.8 cm, finished to match doors

PLINTHS

[see page 221](#)

SP. 22 MM TH. 22 MM

OLTRE **B**ridge

anta finitura fenix

door with fenix finish



bianco caldo (opz.7446)
warm white (opt.7446)



castoro (opz.8864)
beaver (opt.8864)

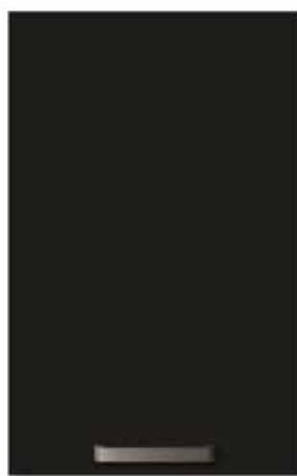

nero (opz.7861)
black (opt.7861)



grigio bromo (opz.9628)
bromine grey (opt.9628)



fumo (opz.9629)
smoke (opt.9629)



cacao orinoco (opz.8865)
cocoa orinoco (opt.8865)



beige arizona (opz.7705)
arizona beige (opt.7705)



grigio efeso (opz.9630)
ephesus grey (opt.9630)



blu fes (opz.8301)
blue fes (opt.8301)

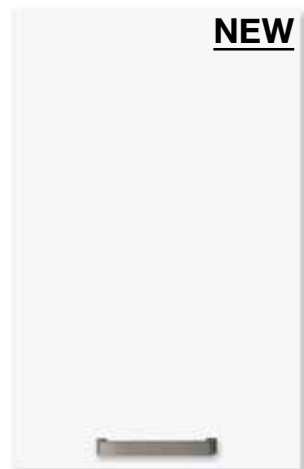

bianco dover (opz.7449)
dover white (opt.7449)

Informazioni tecniche

FENIX NTM™

È un nuovissimo prodotto per l'interior design sviluppato da Arpa Industriale.

Prodotto grazie a resine di nuova generazione, questo materiale intelligente si contraddistingue per una superficie dalle proprietà straordinarie.

Con una bassa riflessione della luce, la sua superficie è estremamente opaca (valore di riflessione speculare: 1,5 e 60°) e anti impronte digitali.

Grazie all'utilizzo della nanotecnologia, eventuali micrograffi possono essere riparati termicamente ed è inoltre piacevolmente soft touch.

FENIX NTM™ è Made in Italy.

FENIX NTM™ è un materiale innovativo di Arpa Industriale creato per l'interior design prodotto mediante l'applicazione simultanea di calore (circa 150°C) e alta pressione specifica (> 7 MPa) per ottenere un prodotto omogeneo non poroso con densità elevata.

Il suo core è composto da carta impregnata in resina termoindurente mentre la superficie decorativa, ottenuta con l'ausilio di nanotecnologie, è costituita da una carta decorativa trattata con resine di nuova generazione frutto della ricerca di Arpa Industriale.

FENIX NTM™ è un materiale che si distingue per particolari caratteristiche quali: alta resistenza al graffio e al calore, anti impronta, morbidezza al tatto, bassa riflessione della luce, riparabilità termica dei micrograffi, alta attività di abbattimento della carica batterica.

FENIX NTM™ è un marchio registrato da Arpa Industriale.

FENIX NTM™ è placcato su truciolare idrorepellente e il top è bordato sui lati a vista con polipropilene spessore 1 mm in tinta.

Technical information

FENIX NTM™

It is a brand new interior design product developed by Arpa Industriale.

Using the most modern resins, this intelligent material stands out for the extraordinary characteristics of its surface.

The matt surface has an exceptionally low reflectivity (specular reflection index: 1.5 and 60°) and is highly resistant to hand and finger prints.

The material uses nanotechnology to enable micro-scratches to be healed thermally, and it also has a very pleasant soft touch effect.

FENIX NTM™ is Made in Italy.

FENIX NTM™ is an innovative interior design product from Arpa Industriale, made by applying heat (around 150°C) and high pressure (> 7 MPa) to obtain a non-porous very dense material.





















Its core is composed of paper impregnated with thermosetting resin, while the surface, which employs nanotechnology processes, is composed of a decorative paper treated with the most recently developed resins from the Arpa Industriale research labs.

FENIX NTM™ stands out for its exceptional resistance to scratching, heat and hand and finger prints, soft touch, low reflectivity, thermal healing of micro-scratches, and effective anti-bacterial action.

FENIX NTM™ is a registered trademark of Arpa Industriale.

FENIX NTM™ is fixed on waterproof fiberboard and the top is trimmed on visible sides with 1 mm polypropylene in matching colour.

FENIX NTM™

- | | | | |
|---|--|---|--|
|  | Resistenza ai graffi e all'abrasione
Resistance to scratches and abrasion |  | Stabilità dimensionale in presenza di elevata variazione termica
Dimensional stability even at high temperature changes |
|  | Alta attività di abbattimento della carica batterica
Enhanced anti-bacterial properties |  | Resistenza all'urto
Resistance to impact |
|  | Igienico
Hygienic |  | Stabilità alla luce
Lightfastness |
|  | Idoneo al contatto con gli alimenti
Suitable for contact with food |  | Resistenza al calore secco
Resistance to dry heat |
|  | Facile da pulire
Easy to clean |  | Eccellente intensità e profondità del colore
Excellent intensity and colour depth |
|  | Antimuffa
Mold-resistant |  | Resistenza allo strofinamento
Rub resistance |
|  | Antistatico
Antistatic |  | Elevata resistenza a solventi acidi e ai reagenti di uso domestico
High resistance to acid solvents and household reagents |
|  | Idrorepellente
Water proof |  | Autoportante (solo per gli spessori 10 e 12 mm)
Self-supporting (only for 10 and 12 mm) |
|  | Bassa riflessione della luce, superficie estremamente opaca
Low light reflection, extremely matt surface |  | Riparabilità termica dei micrograffi
Repairability thermal micro-scratches |
|  | Anti-impronta
Anti-fuella digital |  | Morbidezza al tatto
Soft to the touch |

FENIX NTM™

RIPARABILITÀ TERMICA DEI MICROGRAFFI
Nanotech matt material for interior design



ISTRUZIONI PER LA MANUTENZIONE.
MAINTENANCE

FERRO DA STIRO.
CLOTHES IRON

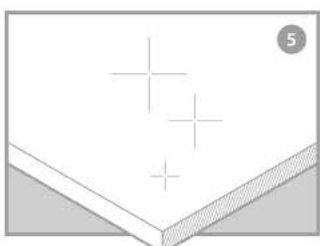
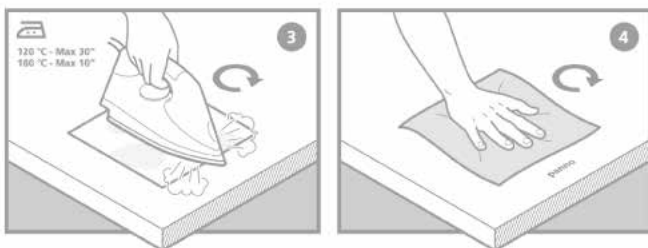
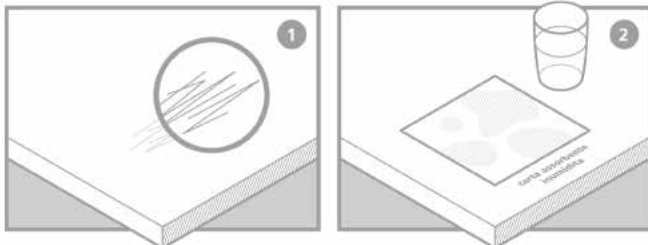

ISTRUZIONI PER LA MANUTENZIONE.
MAINTENANCE

SPUGNA DI SCHIUMA MELAMMINICA.
MELAMINE FOAM SPONGE

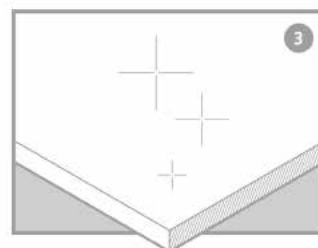
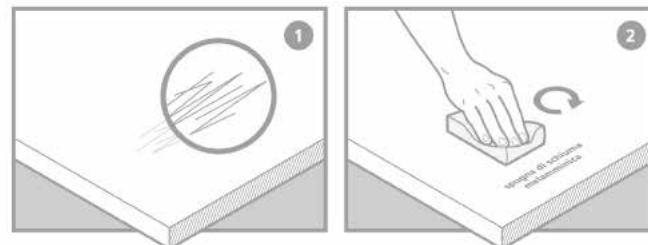

Visiti fenixntm.com
go to fenixntm.com

per scoprire tutte le proprietà
for further details

made in Italy by Arpa Industriale

CARATTERISTICHE TECNICHE

ANTE E FRONTALI CASSETTI

anta sp.22 mm in mdf laccata **finitura opaca testurizzata soft nei colori:**

 [CLICCA QUI PER LA GAMMA COLORI DISPONIBILI](#)

 [CLICK HERE FOR THE RANGE OF AVAILABLE COLORS](#)

MANIGLIE

[vedi pag.206-215](#)

STRUTTURE

di serie: nobilitato bianco (opz.001) schiena e ripiano bianco (opz.001)

a richiesta: nobilitato visone (opz.948M) schiena e ripiano visone (opz.948M)
 nobilitato lavagna (opz.9620) schiena e ripiano lavagna (opz.9620)
 nobilitato perla d'oriente (opz.940) schiena e ripiano bianco (opz.001)
 nobilitato fango (opz.8860) schiena e ripiano fango (opz.8860)
 nobilitato conchiglia (opz.8910) schiena e ripiano conchiglia (opz.8910)
 nobilitato argilla (opz.9690) schiena e ripiano argilla (opz.9690)



MENSOLE

di serie: altezza cm 3,8 in laminato come strutture: bianco (opz.001), perla d'oriente (opz.940), visone (opz.948M), lavagna (opz.9620), fango (opz.8860), argilla (opz.9690), conchiglia (opz.8910)

a richiesta: altezza cm 3,8 laccate opache finiture come ante

ZOCCOLI

[vedi pag.221](#)



cod. **284**

Laccato Lucido Spazzolato

SP. 22 MM

OLTRE **B**ridge

CARATTERISTICHE TECNICHE

ANTE E FRONTALI
CASSETTI

anta sp.22 mm in mdf laccata **finitura lucida spazzolata nei colori:**

 [CLICCA QUI PER LA GAMMA COLORI DISPONIBILI](#)

 [CLICK HERE FOR THE RANGE OF AVAILABLE COLORS](#)

MANIGLIE

[vedi pag.206-215](#)

STRUTTURE

di serie: nobilitato bianco (opz.001) schiena e ripiano bianco (opz.001)

a richiesta: nobilitato visone (opz.948M) schiena e ripiano visone (opz.948M)
nobilitato lavagna (opz.9620) schiena e ripiano lavagna (opz.9620)
nobilitato perla d'oriente (opz.940) schiena e ripiano bianco (opz.001)
nobilitato fango (opz.8860) schiena e ripiano fango (opz.8860)
nobilitato conchiglia (opz.8910) schiena e ripiano conchiglia (opz.8910)
nobilitato argilla (opz.9690) schiena e ripiano argilla (opz.9690)



MENSOLE

di serie: altezza cm 3,8 in laminato come strutture: bianco (opz.001), perla d'oriente (opz.940), visone (opz.948M), lavagna (opz.9620), fango (opz.8860), argilla (opz.9690), conchiglia (opz.8910)

a richiesta: altezza cm 3,8 laccate opache finiture come ante

ZOCCOLI

[vedi pag.221](#)



TECHNICAL FEATURES**DOORS AND
DRAWER FRONTS**

22 mm th. MDF door, with **soft textured matt lacquered finish in the following colours:**

 [CLICCA QUI PER LA GAMMA COLORI DISPONIBILI](#)

 [CLICK HERE FOR THE RANGE OF AVAILABLE COLORS](#)

HANDLES

[see page 206-215](#)

STRUCTURES

standard: melamine-coated white (opt.001), white back panel and shelf (opt.001)

on request: melamine-coated mink (opt.948M), mink back panel and shelf (opt.948M)
melamine-coated slate grey (opt.9620), slate grey back panel and shelf (opt.9620)
melamine-coated oriental pearl (opt.940), white back panel and shelf (opt.001)
melamine-coated mud (opt.8860), mud back panel and shelf (opt.8860)
melamine-coated shell (opt.8910), shell back panel and shelf (opt.8910)
melamine-coated clay (opt.9690), clay back panel and shelf (opt.9690)

SHELVES

standard: : height 3.8 cm, in laminate to match structure: white (opt.001) oriental pearl (opt.940), mink (opt.948M), slate grey (opt.9620), mud (opt.8860), clay (opt.9690), shell (opt.8910)

on request: height 3.8 cm, matt lacquered finish to match doors

PLINTHS

[see page 221](#)

cod. **284**

Brushed Glossy Lacquered

OLTRE **B**ridge

TH. 22 MM

TECHNICAL FEATURES

DOORS AND DRAWER FRONTS

22 mm th. MDF door, with **brushed glossy lacquered finish in the following colours:**

 [CLICCA QUI PER LA GAMMA COLORI DISPONIBILI](#)

 [CLICK HERE FOR THE RANGE OF AVAILABLE COLORS](#)

HANDLES

[see page 206-215](#)

STRUCTURES

standard: melamine-coated white (opt.001), white back panel and shelf (opt.001)

on request: melamine-coated mink (opt.948M), mink back panel and shelf (opt.948M)
melamine-coated slate grey (opt.9620), slate grey back panel and shelf (opt.9620)
melamine-coated oriental pearl (opt.940), white back panel and shelf (opt.001)
melamine-coated mud (opt.8860), mud back panel and shelf (opt.8860)
melamine-coated shell (opt.8910), shell back panel and shelf (opt.8910)
melamine-coated clay (opt.9690), clay back panel and shelf (opt.9690)

SHELVES

standard: : height 3.8 cm, in laminate to match structure: white (opt.001) oriental pearl (opt.940), mink (opt.948M), slate grey (opt.9620), mud (opt.8860), clay (opt.9690), shell (opt.8910)

on request: height 3.8 cm, matt lacquered finish to match doors

PLINTHS

[see page 221](#)

cod. **283**

Laccato Opaco
Matt Lacquered

SP. 22 MM TH. 22 MM

ante laccate opache
matt doors lacquered

OLTRE **B**ridge

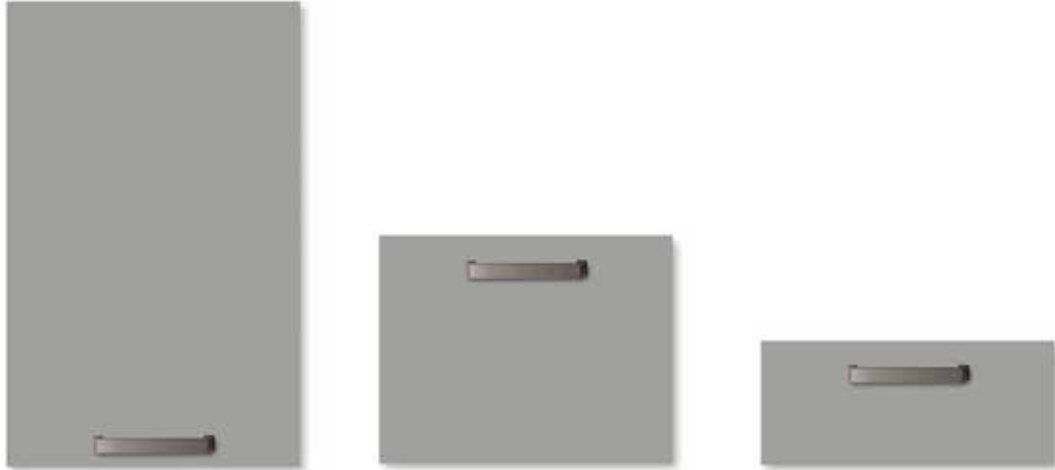

cod. **284**

Laccato Lucido Spazzolato

Brushed Glossy Lacquered

SP. 22 MM TH. 22 MM

ante laccate lucide
glossy doors lacquered

OLTRE **B**ridge



SP. 22 MM

OLTRE **B**ridge**CARATTERISTICHE TECNICHE****ANTE E FRONTALI
CASSETTI**

anta sp.22 mm in mdf laccata **finitura semilucida effetto metallo vintage** nei colori:
peltro (opz.9549), ferro (opz.9506), bronzo (opz.8904)

anta sp.22 mm in mdf laccata **finitura semilucida effetto metallo vintage spazzolato** nei colori:
bronzo anticato (opz.8909), rame anticato (opz.8159), nichel (opz.9505), bronzo brunito (opz.8903), grafite (opz.9508), urban (opz.7894)

MANIGLIE

[vedi pag.206-215](#)

STRUTTURE

ANTE: peltro, ferro, urban, grafite
di serie: nobilitato lavagna (opz.9620) schiena e ripiano lavagna (opz.9620)

ANTE: bronzo, rame anticato, bronzo brunito, bronzo anticato
di serie: nobilitato fango (opz.8860) schiena e ripiano fango (opz.8860)

ANTA: nichel
di serie: nobilitato visone (opz.948M) schiena e ripiano visone (opz.948M)

a richiesta: nobilitato bianco (opz.001) schiena e ripiano bianco (opz.001)
nobilitato perla d'oriente (opz.940) schiena e ripiano bianco (opz.001)
nobilitato conchiglia (opz.8910) schiena e ripiano conchiglia (opz.8910)
nobilitato argilla (opz.9690) schiena e ripiano argilla (opz.9690)

**MENSOLE**

di serie: altezza cm 3,8 in laminato come strutture: bianco (opz.001), perla d'oriente (opz.940), visone (opz.948M), lavagna (opz.9620), fango (opz.8860), argilla (opz.9690), conchiglia (opz.8910)

a richiesta: altezza cm 3,8 finiture come ante

ZOCCOLI

[vedi pag.221](#)



TH. 22 MM

TECHNICAL FEATURES**DOORS AND
DRAWER FRONTS**

22 mm th. door in mdf with **vintage metal effect semi-gloss lacquer finish** in the following colours:
pewter (opt. 9549), iron (opt. 9506), bronze (opt. 8904)

22 mm th. door in mdf with **vintage metal effect semi-gloss lacquer brushed finish** in the following colours:
antique bronze (opt. 8909), antique copper (opt. 8159), nickel (opt. 9505), burnished bronze (opt. 8903),
graphite (opt. 9508), urban (opt. 7894)

HANDLES

[see page 206-215](#)

STRUCTURES

DOORS: pewter, iron, urban, graphite

standard: melamine-coated slate grey (opt.9620), slate grey back panel and shelf (opt.9620)

DOORS: bronze, antique copper, burnished bronze, antique bronze

standard: melamine-coated mud (opt.8860), mud back panel and shelf (opt.8860)

DOOR: nickel

standard: melamine-coated mink (opt.948M), mink back panel and shelf (opt.948M)

on request: melamine-coated white (opt.001), white back panel and shelf (opt.001)

melamine-coated oriental pearl (opt.940), white back panel and shelf (opt.001)

melamine-coated shell (opt.8910), shell back panel and shelf (opt.8910)

melamine-coated clay (opt.9690), clay back panel and shelf (opt.9690)

SHELVES

standard: : height 3.8 cm, in laminate to match structure: white (opt. 001) oriental pearl (opt. 940),
mink (opt. 948M), slate grey (opt. 9620), mud (opt. 8860), clay (opt.9690), shell (opt.8910)

on request: height 3.8 cm, finished to match doors

PLINTHS

[see page 221](#)

SP. 22 MM TH. 22 MM

OLTRE **B**ridge

ante laccate vintage effetto metallo
lacquered vintage doors metal effect



peltro (opz.9549)
pewter (opt.9549)



ferro (opz.9506)
iron opt.9506



bronzo (opz.8904)
bronze (opt.8904)

ante laccate vintage effetto spazzolato
lacquered vintage doors brushed effect



bronzo brunito (opz.8903)
burnished bronze (opt.8903)



grafite (opz.9508)
graphite (opt.9508)



nichel (opz.9505)
nickel (opt.9505)



bronzo antico (opz.8909)
antique bronze (opt.8909)



rame antico (opz.8159)
antique copper (opt.8159)



urban (opz.7894)
urban (opt.7894)

OLTRE **B**ridge Telaio alluminio

Aluminium frame

Vetro
Glass

abbinabile alle versioni: 280-281-282-283-284

matched with versions: 280-281-282-283-284

di serie: telaio alluminio sp.22 mm verniciato a polvere nero,
vetro temperato master line sp.4 mm (opz.NML)

standard: 22mm th. aluminium frame with black powder coating,
4mm th. master line tempered glass (opt.NML)



particolare telaio svasatura esterna
detail frame with external flared



particolare maniglia
detail frame with handle

SP. 22 MM TH. 22 MM

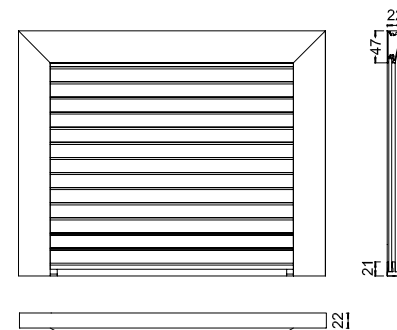

a richiesta: telaio alluminio sp.22 mm verniciato a polvere nero,
vetro temperato bronzo o fumè trasparente sp.4 mm

on request: 22mm th. aluminium frame with black powder coating,
4mm th. tempered bronze or smoked transparent glass

NEW

NEW



vetro bronzo (opz.NBZ)
bronze glass (opt.NBZ)



vetro fumè (opz.NFUM)
smoked glass (opt.NFUM)



particolare maniglia
detail frame with handle

SP. 22 MM TH. 22 MM

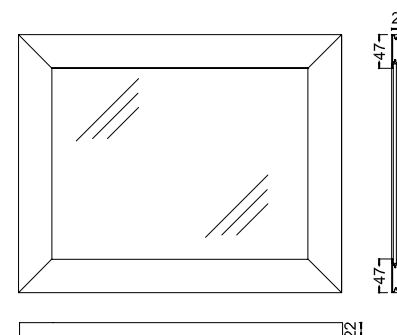

TELAIO
ALLUMINIO
ALUMINIUM FRAME

Vetro Lucido e Satinato

Glossy and Satin Glass

OLTRE **B**ridge

abbinata a OLTRE Neck e Lux
model matched with OLTRE Neck and Lux

Nelle versioni OLTRE BRIDGE è possibile abbinare i vetri colorati delle versioni NECK e LUX

The colored glossy of versions NECK and LUX is possible to match in BRIDGE OLTRE versions

CARATTERISTICHE TECNICHE TECHNICAL FEATURES

Telaio alluminio sp.22 mm verniciato a polvere finitura opaca in tinta con il vetro, tamburato nella parte posteriore con pannello in HDF grigio cenere sp.3 mm.

Vetro temperato satinato sp.4 mm laccato nei colori caldi e freddi.

Vetro temperato lucido sp.4 mm laccato nei colori caldi e freddi.

Aluminium frame Th.22 mm dust painted with matt finish matching with the glass and back coated with an HDF panel colour ash grey.

Hardened satin glass, lacquered in the following hot and cold colours.

Hardened glossy glass, lacquered in the following hot and cold colours.



telaio alluminio, vetro fumo
aluminum frame, smoke glass



particolare retro anta grigio cenere
detail of the back side of the door,
ash grey colour

Neck

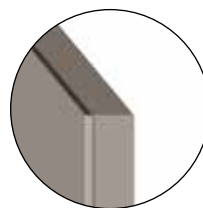

particolare anta squadrata
squared edge door detail

Lux

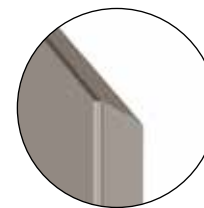

particolare anta inclinata
inclined edge door detail



SP. 22 MM TH. 22 MM

anta vetro satinato satin glass door

OLTRE **N**eck **G55** **L**ux **G65**

COLORI FREDDI SATINATI SATIN COLD COLOURS



COLORI CALDI SATINATI SATIN HOT COLOURS

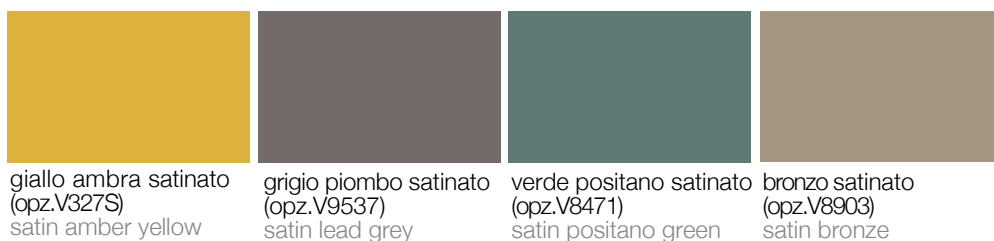

anta vetro lucido glossy glass doors

OLTRE **N**eck **G56** **L**ux **G66**

COLORI FREDDI LUCIDO GLOSSY COLD COLOURS



COLORI CALDI LUCIDO GLOSSY HOT COLOURS



VETRO
COLORATO
COLOURED GLASS

MANIGLIE HANDLES

OLTRE **B**ridge

DI SERIE STANDARD



Maniglia 574 finitura acciaio ossidato brown
 anta L 15 → passo 16 mm
 anta da L 30 a L 60 → passo 160 mm
 anta da L 90 a L 120 → passo 320 mm

Handle 574 brown oxidized steel finish
 door W 15 → centre-to-centre distance 16 mm
 door from W 30 to W 60 → centre-to-centre distance 160 mm
 door from W 90 to W 120 → centre-to-centre distance 320 mm



Maniglia 575 finitura ferro
 anta L 15 → passo 64 mm
 anta da L 30 a L 45 → passo 192 mm
 anta da L 60 a L 120 → passo 320 mm

Handle 575 iron finish
 door W 15 → centre-to-centre distance 64 mm
 door from W 30 to W 45 → centre-to-centre distance 192 mm
 door from W 60 to W 120 → centre-to-centre distance 320 mm



Maniglia 491 finitura inox satinato
 anta L 15 → passo 96 mm
 anta da L 30 a L 60 → passo 160 mm
 anta da L 90 a L 120 → passo 320 mm

Handle 491 stainless steel satin finish
 door W 15 → centre-to-centre distance 96 mm
 door from W 30 to W 60 → centre-to-centre distance 160 mm
 door from W 90 to W 120 → centre-to-centre distance 320 mm



Maniglia 477 finitura cromo
 anta L 15 → passo 64 mm
 anta da L 30 a L 45 → passo 160 mm
 anta da L 60 a L 120 → passo 320 mm

Handle 477 chrome finish
 door W 15 → centre-to-centre distance 64 mm
 door from W 30 to W 45 → centre-to-centre distance 160 mm
 door from W 60 to W 120 → centre-to-centre distance 320 mm

A RICHIESTA ON REQUEST



Maniglia 576 finitura urban
 anta L 15 → passo 96 mm
 anta da L 30 a L 45 → passo 160 mm
 anta da L 60 a L 120 → passo 320 mm

Handle 576 urban finish
 door W 15 → centre-to-centre distance 96 mm
 door from W 30 to W 45 → centre-to-centre distance 160 mm
 door from W 60 to W 120 → centre-to-centre distance 320 mm



Maniglia 585 finitura acciaio ossidato semiopaco
 anta L 15 → passo 64 mm
 anta da L 30 a L 120 → passo 160 mm

Handle 585 half-matt oxidized steel finish
 door W 15 → centre-to-centre distance 64 mm
 door from W 30 to W 120 → centre-to-centre distance 160 mm



Maniglia 578G finitura old grey
 anta L 15 → passo 64 mm
 anta da L 30 a L 45 → passo 192 mm
 anta da L 60 a L 120 → passo 320 mm

Handle 578G old grey finish
 door W 15 → centre-to-centre distance 64 mm
 door from W 30 to W 45 → centre-to-centre distance 192 mm
 door from W 60 to W 120 → centre-to-centre distance 320 mm



Maniglia 551 finitura cromo
 anta L 15 → passo 64 mm
 anta da L 30 a L 45 → passo 160 mm
 anta da L 60 a L 120 → passo 320 mm

Handle 551 chrome finish
 door W 15 → centre-to-centre distance 64 mm
 door from W 30 to W 45 → centre-to-centre distance 160 mm
 door from W 60 to W 120 → centre-to-centre distance 320 mm



Maniglia 581 finitura bronzo titanio
 anta L 15 → passo 64 mm
 anta da L 30 a L 120 → passo 128 mm

Handle 581 titanium bronze finish
 door W 15 → centre-to-centre distance 64 mm
 door from W 30 to W 120 → centre-to-centre distance 128 mm

AD INCASSO RECESSED

A RICHIESTA ON REQUEST



Maniglia 59RA finitura anodizzato rame anticato
anta L 15 → passo 32 mm
anta L 30 a L 45 → passo 160 mm
anta da L 60 a L 120 → passo 448 mm

Handle 59RA oxidized antique copper finish
door W 15 → centre-to-centre distance 32 mm
door W 30 to W 45 → centre-to-centre distance 160 mm
door from W 60 to W 120 → centre-to-centre distance 448 mm



Maniglia 59BA finitura anodizzato bronzo anticato
anta L 15 → passo 32 mm
anta L 30 a L 45 → passo 160 mm
anta da L 60 a L 120 → passo 448 mm

Handle 59BA oxidized antique bronze finish
door W 15 → centre-to-centre distance 32 mm
door W 30 to W 45 → centre-to-centre distance 160 mm
door from W 60 to W 120 → centre-to-centre distance 448 mm



Maniglia 59BB finitura anodizzato titanio
anta L 15 → passo 32 mm
anta L 30 a L 45 → passo 160 mm
anta da L 60 a L 120 → passo 448 mm

Handle 59BB oxidized titanium finish
door W 15 → centre-to-centre distance 32 mm
door W 30 to W 45 → centre-to-centre distance 160 mm
door from W 60 to W 120 → centre-to-centre distance 448 mm



Maniglia 59F finitura anodizzato grafite
anta L 15 → passo 32 mm
anta L 30 a L 45 → passo 160 mm
anta da L 60 a L 120 → passo 448 mm

Handle 59F oxidized graphite finish
door W 15 → centre-to-centre distance 32 mm
door W 30 to W 45 → centre-to-centre distance 160 mm
door from W 60 to W 120 → centre-to-centre distance 448 mm



Maniglia 59K finitura anodizzato acciaio
anta L 15 → passo 32 mm
anta L 30 a L 45 → passo 160 mm
anta da L 60 a L 120 → passo 448 mm

Handle 59K oxidized stainless steel finish
door W 15 → centre-to-centre distance 32 mm
door W 30 to W 45 → centre-to-centre distance 160 mm
door from W 60 to W 120 → centre-to-centre distance 448 mm



Maniglia 59N finitura anodizzato nero
anta L 15 → passo 32 mm
anta L 30 a L 45 → passo 160 mm
anta da L 60 a L 120 → passo 448 mm

Handle 59N oxidized black finish
door W 15 → centre-to-centre distance 32 mm
door W 30 to W 45 → centre-to-centre distance 160 mm
door from W 60 to W 120 → centre-to-centre distance 448 mm



Maniglia 57RA finitura rame anticato
anta L 15 → passo 12 mm
anta L 30 a L 45 → passo 160 mm
anta da L 60 a L 120 → passo 320 mm

Handle 57RA antique copper finish
door W 15 → centre-to-centre distance 12 mm
door W 30 to W 45 → centre-to-centre distance 160 mm
door from W 60 to W 120 → centre-to-centre distance 320 mm



Maniglia 57BA finitura bronzo anticato
anta L 15 → passo 12 mm
anta L 30 a L 45 → passo 160 mm
anta da L 60 a L 120 → passo 320 mm

Handle 57BA antique bronze finish
door W 15 → centre-to-centre distance 12 mm
door W 30 to W 45 → centre-to-centre distance 160 mm
door from W 60 to W 120 → centre-to-centre distance 320 mm



Maniglia 57BB finitura bronzo brunito
anta L 15 → passo 12 mm
anta L 30 a L 45 → passo 160 mm
anta da L 60 a L 120 → passo 320 mm

Handle 57BB burnished bronze finish
door W 15 → centre-to-centre distance 12 mm
door W 30 to W 45 → centre-to-centre distance 160 mm
door from W 60 to W 120 → centre-to-centre distance 320 mm



Maniglia 57F finitura grafite
anta L 15 → passo 12 mm
anta L 30 a L 45 → passo 160 mm
anta da L 60 a L 120 → passo 320 mm

Handle 57F graphite finish
door W 15 → centre-to-centre distance 12 mm
door W 30 to W 45 → centre-to-centre distance 160 mm
door from W 60 to W 120 → centre-to-centre distance 320 mm



Maniglia 57K finitura nichel
anta L 15 → passo 12 mm
anta L 30 a L 45 → passo 160 mm
anta da L 60 a L 120 → passo 320 mm

Handle 57K nickel finish
door W 15 → centre-to-centre distance 12 mm
door W 30 to W 45 → centre-to-centre distance 160 mm
door from W 60 to W 120 → centre-to-centre distance 320 mm



Maniglia M42 finitura nichel satinata
 passo in funzione dell'anta
 Handle M42 nickel satin finish
 centre-to-centre distance varies according to the door

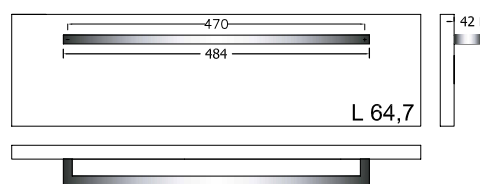
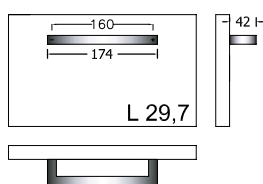
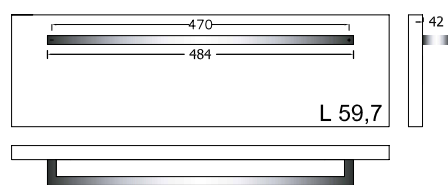
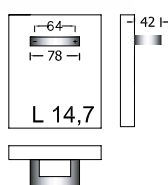

ANGOLO PENSILE A LIBRO
 corner wall unit folding

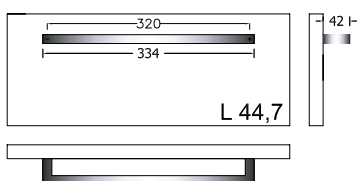
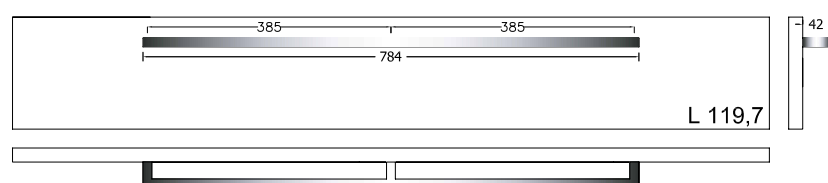
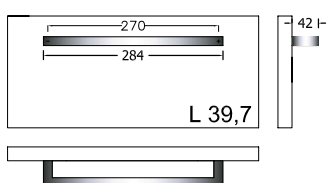
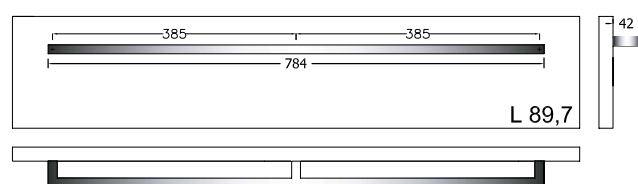
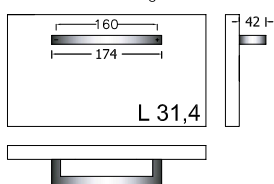

MANIGLIA ORIZZONTALE HANDLE HORIZONTAL

OLTRE **B**ridge



Maniglia M41 finitura ferro grezzo
 passo in funzione dell'anta
 Handle M41 unrefined iron finish
 centre-to-centre distance varies according to the door

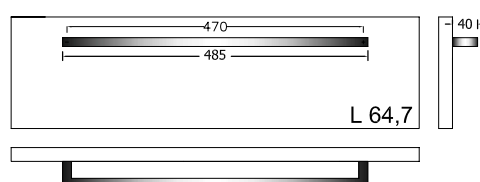
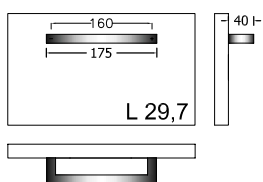
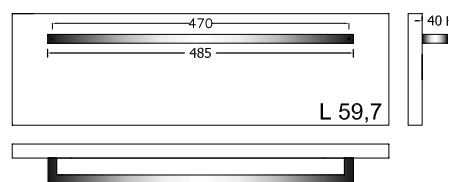
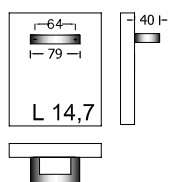

ANGOLO PENSILE A LIBRO
 corner wall unit folding

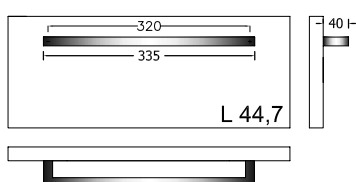
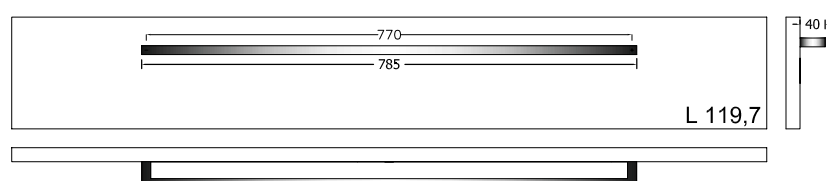
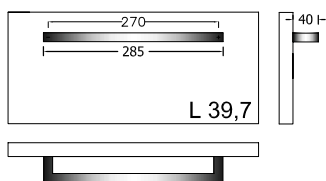
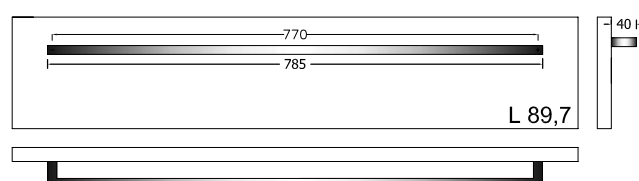
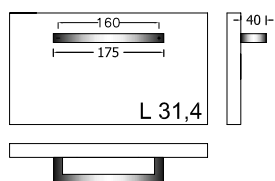

MANIGLIA VERTICALE HANDLE VERTICAL

OLTRE **B**ridge



Maniglia M42V finitura nichel satinata
 passo in funzione dell'anta
 Handle M42V nickel satin finish
 centre-to-centre distance varies according to the door

N.B.: la maniglia verticale non è disponibile per tutti gli elementi. Non inseribile su pensili, basi con cassetti e cestone
 Note: The vertical handle is not compatible with all the elements. Is not possible to insert it on the wall units and base units with drawers and deep drawers.

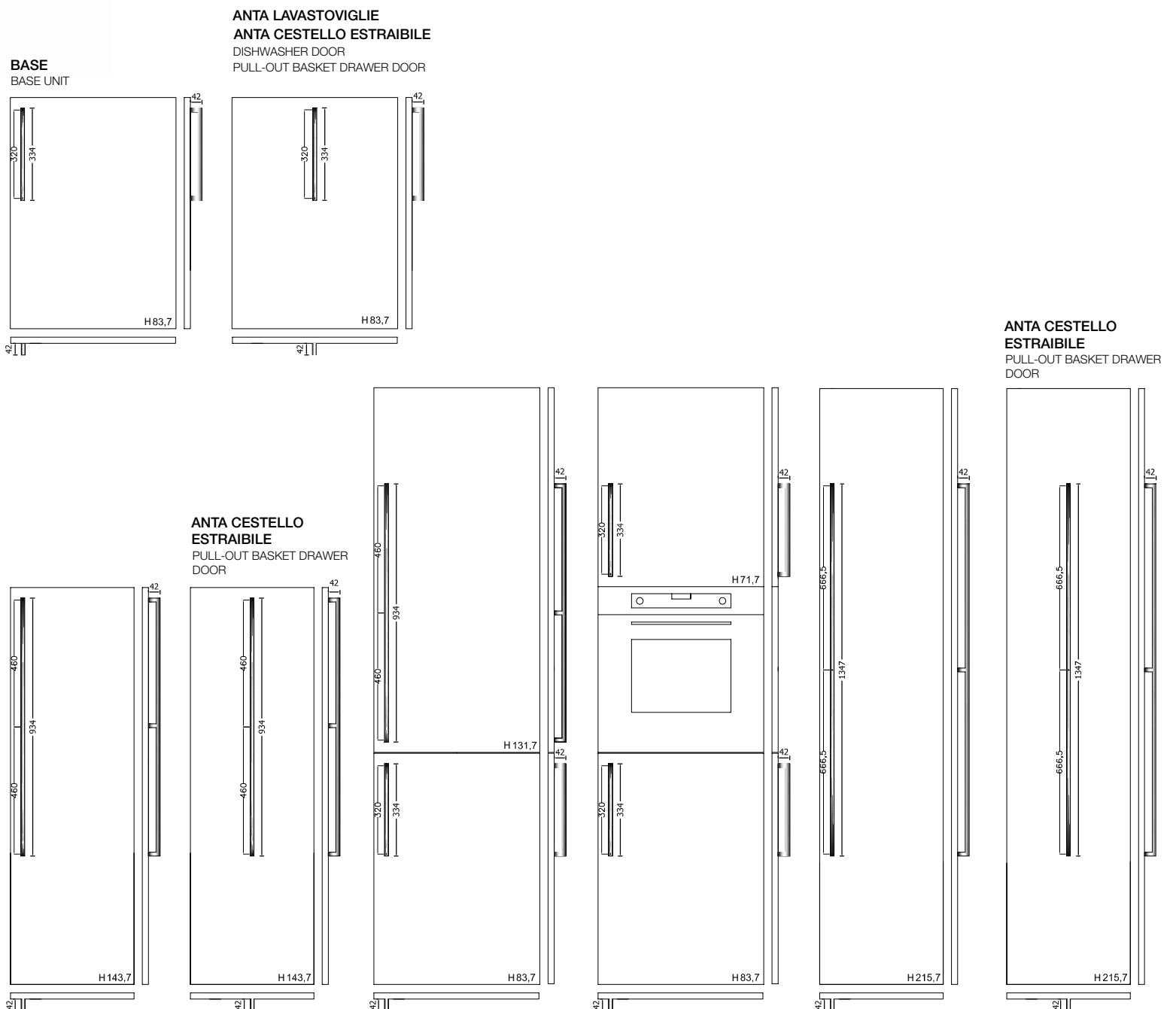

MANIGLIA APPLICATA IN TESTA TOP-MOUNTED HANDLE

OLTRE **B**ridge

N.B.: In presenza di questa maniglia non si possono tassativamente realizzare fuori misura in larghezza.
Note: Custom-sized length elements cannot be realized using this handle.



Maniglia H51 finitura urban . vedi schema tecnico

Handle H51 urban finish size see technical diagram



Maniglia H52 finitura titanio vedi schema tecnico

Handle H52 titanium finish size see technical diagram



SCHEMA MANIGLIA

HANDLE DIAGRAM

MANIGLIA APPLICATA IN TESTA TOP-MOUNTED HANDLE

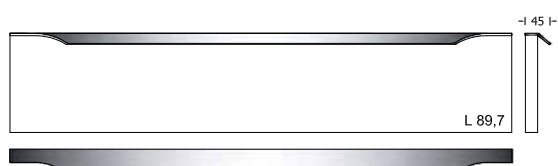
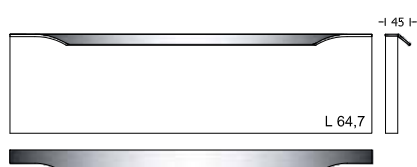
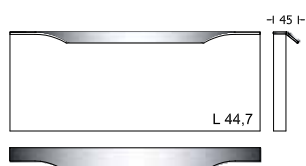
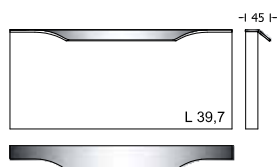
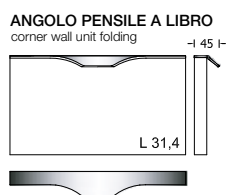
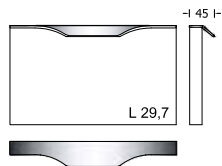
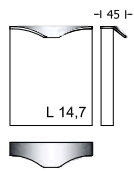

MANIGLIA FRONTALE PER ANTA COLONNA FRONT DOOR HANDLE FOR COLUMN

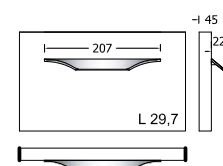
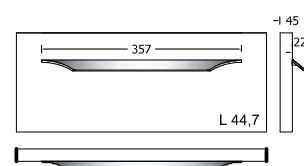
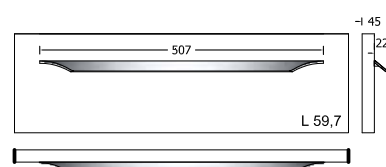
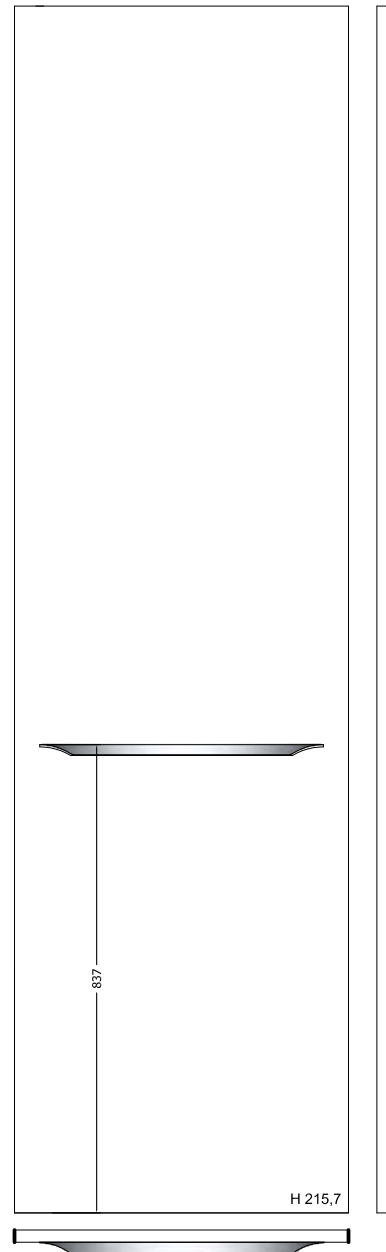

MANIGLIA FUSION

FUSION HANDLE

OLTRE **B**ridge



Maniglia fusion FU11
finitura nero opaco
passo in funzione dell'anta
vedi schema tecnico
Handle fusion FU11 matt black finish
centre-to-centre distance varies according
to the door
size see technical diagram



particolare maniglia fusion nero opaco
detail black fusion matt black handle



Maniglia fusion FU12
finitura titanio
passo in funzione dell'anta
vedi schema tecnico
Handle fusion FU12 titanium finish
centre-to-centre distance varies according
to the door
size see technical diagram



particolare maniglia fusion titanio
detail titanium fusion handle



SCHEMA MANIGLIA

HANDLE DIAGRAM

N.B.: non inseribile su pensili, basi cassetti e cestoni
Note.: not inserted on wall units, base units drawers and deep drawers

OLTRE **B**ridge

BASI H 90

BASE UNITS H 90

BASE
BASE UNIT

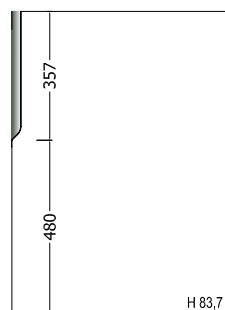

ANTA LAVASTOVIGLIE
CON SERVO-DRIVE FLEX
DISHWASHER DOOR
WITH SERVO-DRIVE FLEX

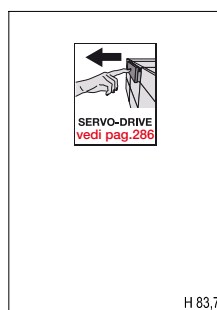

COLONNE H 114-150

COLUMNS H 114-150

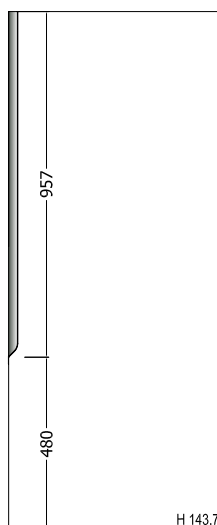
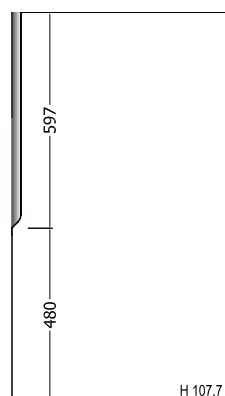

COLONNE H 222

COLUMNS H 222

ANTA COLONNA ATTREZZATA
COLUMN EQUIPPED DOOR

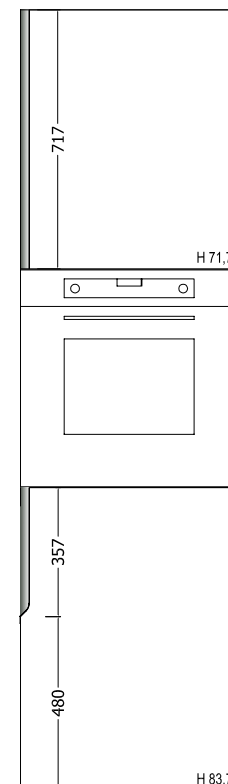
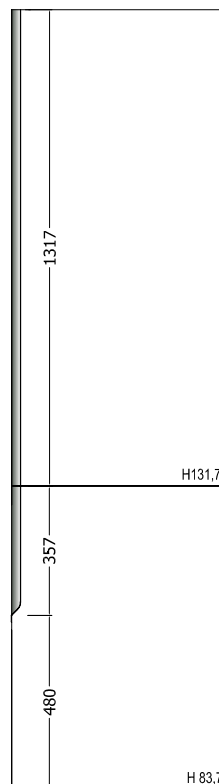
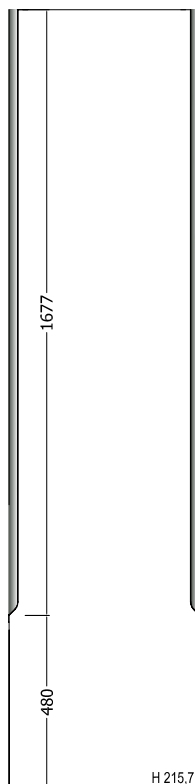
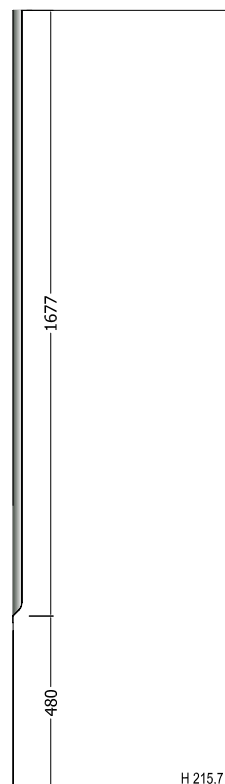



LA COLLEZIONE HI-LINE
RIVOLUZIONA IL CONCETTO DEI
MATERIALI E DEI COMPLEMENTI CHE
COSTITUISCONO UNA CUCINA.
ELEMENTI IN ALLUMINIO, ANTE AD
EFFETTO METALLO, ACCESSORI DAL
DESIGN UNICO, APPOSITAMENTE CREATI
PER ESALTARE IL PROGRAMMA OLTRE.

THE HI-LINE COLLECTION CHANGES THE CONCEPT
OF MATERIALS AND ACCESSORIES THAT MAKES UP A KITCHEN.
ALUMINIUM ELEMENTS, DOORS FINISHES WITH METAL
EFFECT AND ACCESSORIES WITH A UNIQUE DESIGN, HAVE BEEN
CREATED TO ENHANCE THE OLTRE PROGRAM.

OLTRE

Hi-line

COMPLEMENTI
DI ALTO LIVELLO
HIGH LEVEL ACCESSORIES



SP. 22 MM TH. 22 MM

OLTRE

CARATTERISTICHE TECNICHE

ANTE E FRONTALI CASSETTI

anta sp.22 mm composta da un telaio di alluminio estruso dove viene alloggiata sul fronte una lamina imbutita e sul retro un pannello di tamponamento entrambi in alluminio.
Tra le due lamiere nell'intercapedine viene inserito un materiale con proprietà fonoassorbenti e termoisolanti capaci di rendere l'anta consistente pur mantenendo la sua leggerezza.
L'anta Hi-line forte del proprio design è interamente riciclabile.
La finitura dell'anta viene realizzata con un unico bagno anodico nei colori: nero (opz.AL11) e titanio (opz.AL12)

MANIGLIE

AL11 finitura nera passo mm 192
AL12 finitura titanio passo mm 192

N.B.: disponibilità apertura senza maniglia

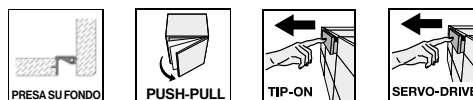

STRUTTURE

ANTA: nero
nobilitato lavagna (opz.9620) schiena e ripiano lavagna (opz.9620)
ANTA: titanio
nobilitato fango (opz.8860) schiena e ripiano fango (opz.8860)



MENSOLE

altezza cm 3,8 in laminato come strutture: lavagna (opz.9620), fango (opz.8860)

ZOCCOLI

zoccolo H 6 in alluminio titanio ossidato (opz.414)
zoccolo H 6 in alluminio verniciato a polvere finitura opaca nel colore: nero (opz.7892)

TECHNICAL FEATURES

DOORS AND DRAWER FRONTS

Th. mm 22 door composed by an extruded aluminum frame. In the front side of the door is placed an aluminum deep-drawn foil and on the back side an aluminum filler panel.
In the gap between the two sheets it is inserted a material with sound-absorbing and heat-insulating properties, that can make the door more consistent, without modify its lightweight.
The Hi-line door is completely recyclable.
The door finish is realized with a single anodic bath in the colors: black (opt.AL11) and titanium (opt.AL12)

HANDLES

AL11 black finish centre-to-centre distance 192 mm
AL12 titanium finish centre-to-centre distance 192 mm

Note: no handle opening available

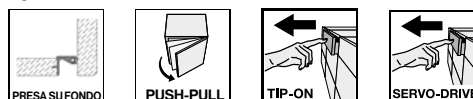

STRUCTURES

DOOR: black
melamine-coated slate grey (opt.9620), slate grey back panel and shelf (opt.9620)
DOOR: titanium
melamine-coated mud (opt.8860), mud back panel and shelf (opt.8860)

SHELVES

height 3.8 cm, in laminate to match structure: slate grey (opt.9620), mud (opt.8860)

PLINTHS

plinth H 6 cm in aluminium with oxidised titanium (opt.414)
plinth H 6 cm in aluminium with matt powder coating in the following colours: black (opt.7892),



OLTRE

SP. 22 MM TH. 22 MM

anta Hi-line con maniglia

Hi-line door with handle



anta nera (opz.AL11)
black door (opt.AL11)



anta titanio (opz.AL12)
titanium door (opt.AL12)



particolare maniglia
detail frame with
handle

SP. 22 MM TH. 22 MM

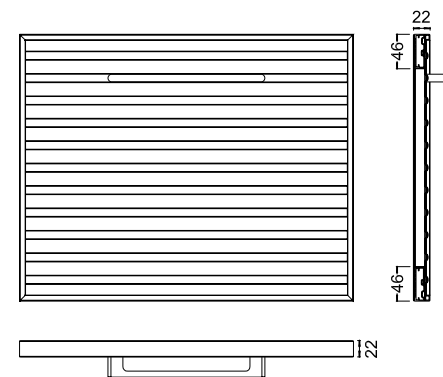

anta Hi-line senza maniglia

Hi-line door without handle



anta nera (opz.AL11)
black door (opt.AL11)



anta titanio (opz.AL12)
titanium door (opt.AL12)

SP. 22 MM TH. 22 MM

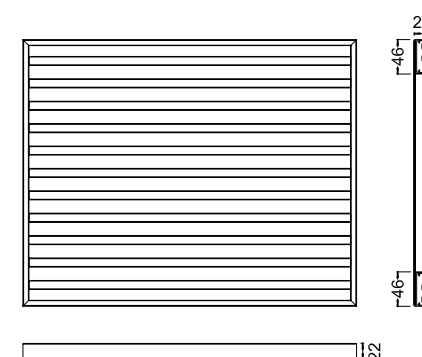

strutture carcasses

NEW

NEW



bianco (opz.001)
schiena e ripiano bianco
(opz.001)
white (opt.001)
white back panel and shelf
(opt.001)



perla d'oriente (opz.940)
schiena e ripiano bianco
(opz.001)
oriental pearl (opt.940)
white back panel and shelf
(opt.001)



conchiglia (opz.8910)
schiena e ripiano conchiglia
(opz.8910)
shell (opt.8910)
shell back panel and shelf
(opt.8910)



argilla (opz.9690)
schiena e ripiano argilla
(opz.9690)
clay (opt.9690)
clay back panel and shelf
(opt.9690)



lavagna (opz.9620)
schiena e ripiano lavagna
(opz.9620)
slate grey (opt.9620)
slate grey back panel
and shelf (opt.9620)



fango (opz.8860)
schiena e ripiano fango
(opz.8860)
mud (opt.8860)
mud back panel and
shelf (opt.8860)



visone (opz.948M)
schiena e ripiano visone
(opz.948M)
mink (opt.948M)
mink back panel and shelf
(opt.948M)



LUBE ECOLOGIC

IL GRUPPO LUBE HA SCELTO DI UTILIZZARE PER I COMPONENTI COSTITUENTI LE STRUTTURE DELLE CUCINE SOLO MATERIALE A BASSISSIMA EMISSIONE DI FORMALDEIDE: CONFORMI ALLO STANDARD F**** SECONDO LA NORMA JIS, CERTIFICATO DAL MINISTERO GIAPPONESE, IL PIU' SEVERO IN MERITO ALLE NORMATIVE DI SALVAGUARDIA AMBIENTALE.

LUBE GROUP HAS CHOSEN TO EXCLUSIVELY USE MATERIALS WITH VERY LOW FORMALDEHYDE EMISSIONS FOR THE COMPONENTS MAKING UP THE KITCHEN CARCASSES: THESE ELEMENTS COMPLY WITH THE F4 STAR STANDARD ACCORDING TO JIS, CERTIFIED BY THE JAPANESE GOVERNMENT - THE MOST STRINGENT WHEN IT COMES TO ENVIRONMENTAL PROTECTION.

mensole in laminato P 31-61 come strutture same colours as carcasses laminated shelves D 31-61



bianco (opz.001)
white (opt.001)



perla d'oriente (opz.940)
oriental pearl (opt.940)

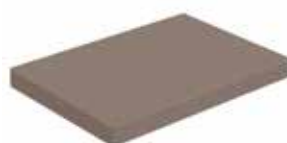

fango (opz.8860)
mud (opt.8860)



visone (opz.948M)
mink (opt.948M)



lavagna (opz.9620)
slate grey (opt.9620)

NEW

NEW



argilla (opz.9690)
clay (opt.9690)



conchiglia (opz.8910)
shell (opt.8910)

mensole impialacciate veneered shelves



impialacciata come anta
N.B.: per le finiture vedi pagina 184
veneered same finish as door
Note: for the finishes see page 184

mensole fenix fenix shelves

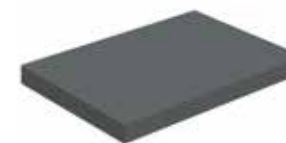

fenix come anta
N.B.: per le finiture vedi pagina 188
fenix as door
Note: for the finishes see page 188

mensole laccate lacquered shelves

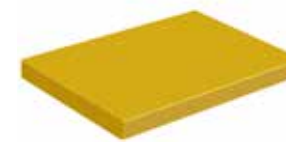

laccate opache e lucide come anta
N.B.: per le finiture vedi pagine 198-199
matt and glossy lacquered as door
Note: for the finishes see pages 198-199

mensole laccate vintage vintage lacquered shelves



laccate vintage come anta
N.B.: per le finiture vedi pagina 202
vintage lacquered as door
Note: for the finishes see page 202

zoccoli in alluminio H 6 aluminium plinth H 6

di serie
standard



alluminio finitura titanio
ossidato (opz.414)
aluminium titanium
oxidized finish (opt.414)

**N.B.: ABBINAMENTO CONSIGLIATO
CON L'ANTA BRONZO BRUNITO
NOTE: BEST MATCHING WITH THE
BURNISHED BRONZE DOOR**

zoccoli in alluminio H 6 aluminium plinth H 6

a richiesta
on request



alluminio finitura urban
ossidato (opz.NU)
aluminium urban
oxidized finish (opt.NU)



alluminio
finitura brill (opz.412)
aluminium
brill finish (opt.412)

NEW



alluminio finitura rame
anticato (opz.422)
aluminium antique
copper finish
(opt.422)

NEW



alluminio finitura
grafite (opz.421)
aluminium graphite
finish (opt.421)

NEW



alluminio finitura nichel
(opz.420)
aluminium nickel
finish (opt.420)

NEW



alluminio finitura
bronzo anticato
(opz.423)
aluminium antique
bronze finish (opt.423)

zoccoli in alluminio H 6 verniciati a polvere finitura opaca aluminum plinth height H 6 powder coated matt finish



alluminio finitura nero
(opz.7892)
aluminium
black finish (opt.7892)



alluminio finitura fumo
(opz.9531)
aluminium
smoke finish
(opt.9531)



alluminio finitura
bianco caldo (opz.7401)
aluminium warm white
finish (opt.7401)



alluminio finitura
bianco assoluto (opz.740S)
aluminium absolute
white finish (opt.740S)



alluminio finitura
verde positano
(opz.8471)
aluminium positano
green finish (opt.8471)



alluminio finitura
acquamarina
(opz.8323)
aluminium
aquamarine finish
(opt.8323)



alluminio finitura
castoro (opz.8907)
aluminium beaver
finish (opt.8907)



alluminio finitura rosso
toscano (opz.8157)
aluminium tuscan red
finish (opt.8157)



alluminio finitura grigio
bromo (opz.9533)
aluminium bromine
grey finish (opt.9533)



alluminio finitura
silver dark (opz.9507)
aluminium dark silver
finish (opt.9507)



alluminio finitura
argilla (opz.9503)
aluminium clay
finish (opt.9503)



alluminio finitura
conchiglia (opz.7403)
aluminium shell
finish (opt.7403)



alluminio finitura
ghisa (opz.9509)
aluminium cast iron
finish (opt.9509)



alluminio bistro
(opz.9535)
aluminium bistro
finish (opt.9535)



alluminio finitura
grigio selce (opz.SE)
aluminium flint grey
finish (opt.SE)

MODULARITÀ E COMPONIBILITÀ MODULARITY AND FITTING SOLUTIONS

- ESCLUSO 65 EXCLUDING 65
- ESCLUSO 45 EXCLUDING 45
- ESCLUSO 120 EXCLUDING 120
- ★ SOLO 90 ONLY 90

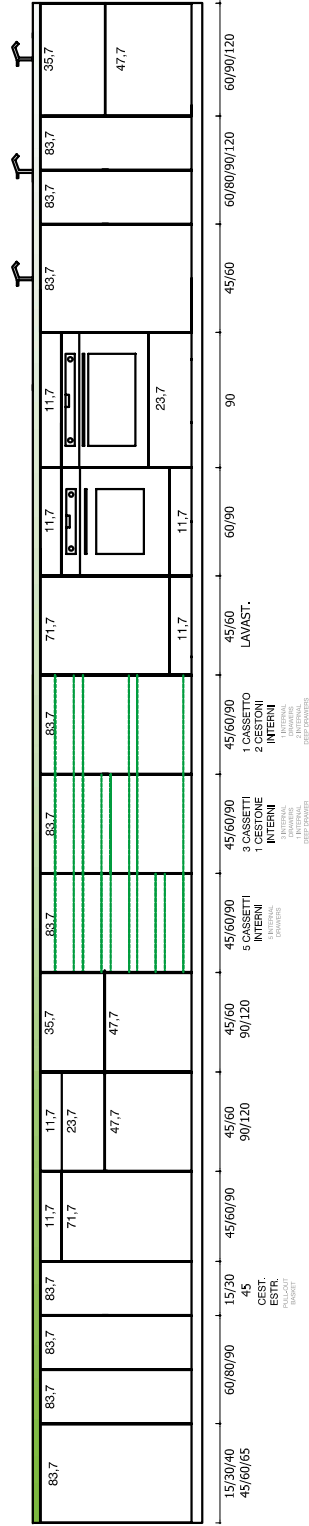
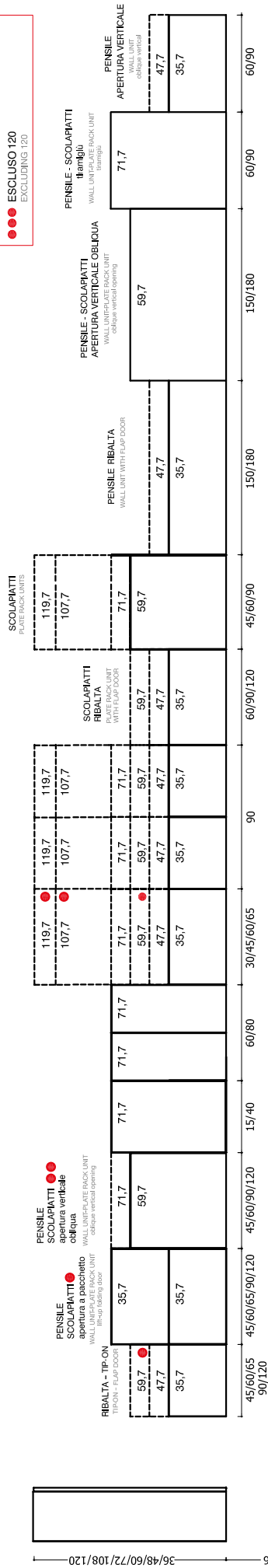

BASI H 78

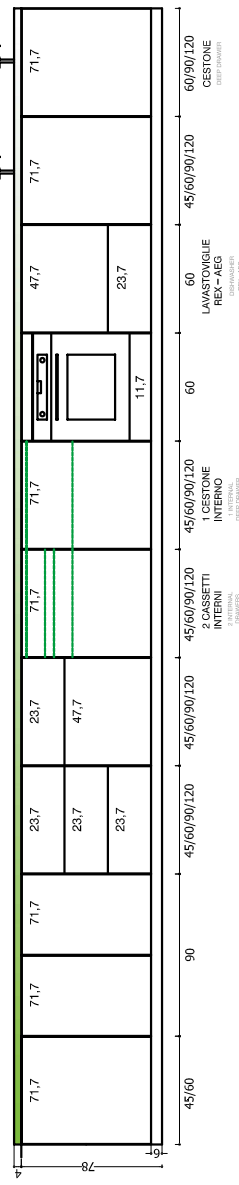
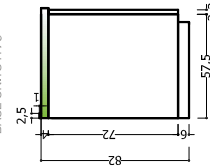

BASI ROOM LIVING

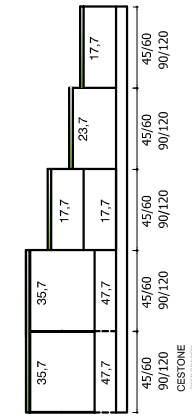
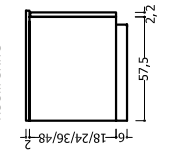

COLONNE H 114 - 150

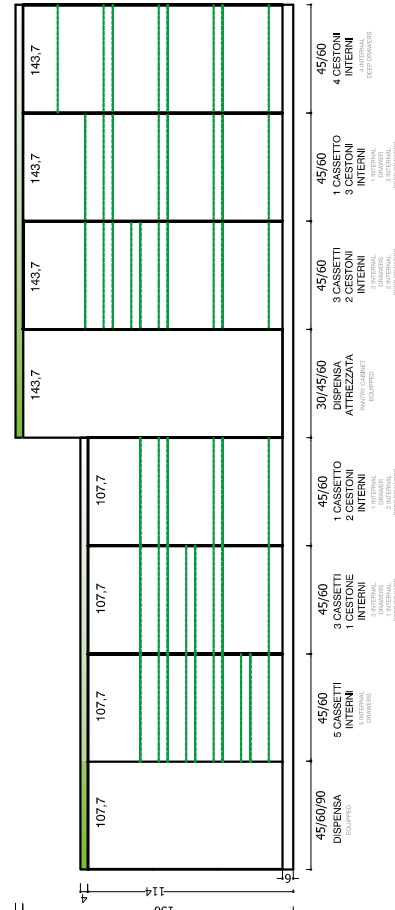
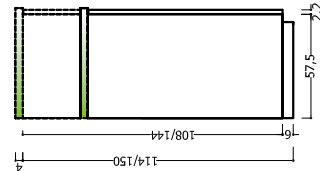

BASI SOSEPSE HANGING BASE UNITS

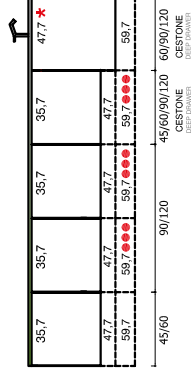
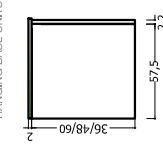

ELEMENTI A GIORNO IN ALLUMINIO “AIR” HI-LINE

ALUMINIUM OPEN UNITS “AIR” HI-LINE

Gli elementi a giorno “AIR” sono realizzati con profilo da mm 20x20 e schienale in alluminio con ripiani in vetro bronzo 4 mm. temperato.

“AIR” open units are realized with a mm 20x20 profile, aluminium back panel and tempered bronze glass th 4 mm.



FINITURE FINISHES



nero (opz.AL11)
black (opt.AL11)



titanio (opz.AL12)
titanium (opt.AL12)

CONTENITORI "AIR"

"AIR" CONTAINER SHELVES

La linea "AIR" può essere personalizzata con dei contenitori impiallacciati e fenix realizzati in folding (vedi pag.317)

The "AIR" line can be customized with several container shelves made with folding process, in veneered or fenix finishes (see page 317)



ELEMENTI A GIORNO
OPEN UNITS

FINITURE IMPIALLACCiate

VENEERED FINISHES



rovere bianco invecchiato
(opz.5380)
white aged oak (opt.5380)



rovere juta invecchiato
(opz.5381)
jute aged oak (opt.5381)



rovere corteccia invecchiato
(opz.5382)
bark aged oak (opt.5382)



rovere mielato invecchiato
(opz.5383)
honey aged oak (opt.5383)



rovere antracite invecchiato
(opz.5384)
anthracite aged oak
(opt.5384)



rovere argilla invecchiato
(opz.5385)
clay aged oak (opt.5385)



rovere moro invecchiato
(opz.5386)
dark aged oak (opt.5386)



rovere grigio terra (opz.5389)
grey earth oak (opt.5389)



rovere naturale invecchiato
parquettato (opz.5387)
parquet-effect natural
aged oak (opt.5387)



rovere madera termocotto
(opz.5388)
heat treated mader oak
(opt.5388)

FINITURE FENIX

FENIX FINISHES



bianco caldo (opz.7446)
warm white (opt.7446)



castoro (opz.8864)
beaver (opt.8864)

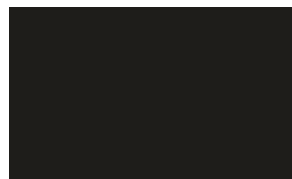

nero (opz.7861)
black (opt.7861)



grigio bromo (opz.9628)
bromine grey (opt.9628)



fumo (opz.9629)
smoke (opt.9629)

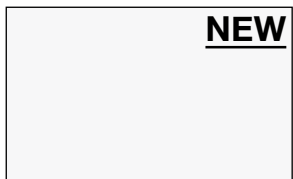

bianco dover (opz.7449)
dover white (opt.7449)



cacao orinoco (opz.8865)
cocoa orinoco (opt.8865)

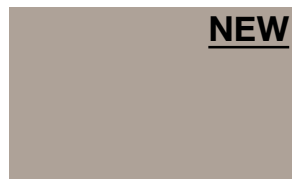

beige arizona (opz.7705)
arizona beige (opt.7705)

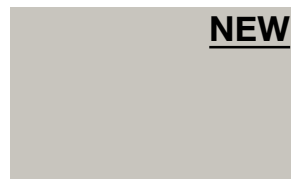

grigio efeso (opz.9630)
ephesus grey (opt.9630)



blu fes (opz.8301)
blue fes (opt.8301)

ELEMENTI A GIORNO IN LAMIERA VERNICIATI A POLVERE SP.2 MM

POWDER PAINTED METAL SHEET OPEN UNITS TH.2 MM



colori freddi opachi soft soft matt cold colours

bianco assoluto (opz.740S) absolute white	grigio bromo (opz.9533) bromine grey	grigio traffico (opz.9511) traffic grey	argilla (opz.9503) clay	silver dark (opz.9507) dark silver
---	--	---	-------------------------------	--

colori caldi opachi soft soft matt hot colours

bianco caldo (opz.7401) warm white	grigio kenya (opz.9501) kenya grey	castoro (opz.8907) beaver	fumo (opz.9531) smoke	bistro (opz.9535) bistro	ghisa (opz.9509) cast iron
conchiglia (opz.7403) shell	lino (opz.9513) linen	creta (opz.9515) clay	mandorla (opz.W820) almond	visone (opz.9463) mink	verde positano (opz.8471) positano green
rosso toscano (opz.8157) tuscan red	grigio selce (opz.95SE) flint grey	acquamarina (opz.8323) aquamarine			

ELEMENTI A GIORNO SP. 14 MM

OPEN ELEMENTS TH.14 MM



COLORI IMPIALLACCIATI VENEERED COLOURS



COLORI LACCATI OPACHI MATT LACQUERED COLOURS

MOBILE DI COMPLEMENTO

ACCESSORY FURNITURE



COLORI LACCATI VINTAGE EFFETTO METALLO

LACQUERED VINTAGE COLOURS METAL EFFECT

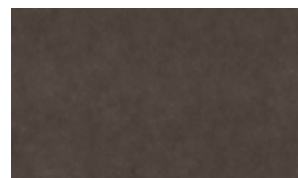

peltro (opz.9549)
pewter (opt.9549)



ferro (opz.9506)
iron (opt.9506)



urban (opz.7894)
urban (opt.7894)

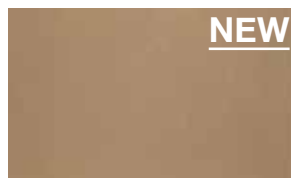

NEW

bronzo antico (opz.8909)
antique bronze (opt.8909)



NEW

rame antico (opz.8159)
antique copper (opt.8159)



NEW

nichel (opz.9505)
nickel (opt.9505)

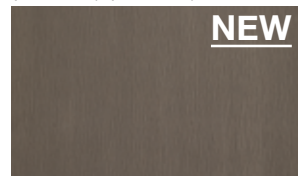

NEW

bronzo brunito (opz.8903)
burnished bronze (opt.8903)

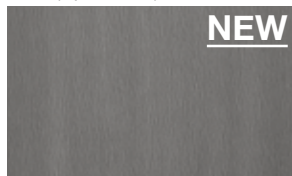

NEW

grafite (opz.9508)
graphite (opt.9508)

COLORI IMPIALLACCIATI DISPONIBILI SOLO PER BASI

VENEERED COLOURS AVAILABLE ONLY FOR BASE UNITS



rovere bianco invecchiato (opz.5380)
white aged oak (opt.5380)



rovere juta invecchiato (opz.5381)
jute aged oak (opt.5381)



rovere corteccia invecchiato (opz.5382)
bark aged oak (opt.5382)



rovere mielato invecchiato (opz.5383)
honey aged oak (opt.5383)



rovere antracite invecchiato (opz.5384)
anthracite aged oak (opt.5384)



rovere argilla invecchiato (opz.5385)
clay aged oak (opt.5385)



rovere moro invecchiato (opz.5386)
dark aged oak (opt.5386)



rovere grigio terra (opz.5389)
grey earth oak (opt.5389)



rovere naturale invecchiato parquetto (opz.5387)
parquet-effect natural aged oak (opt.5387)



rovere madera termocotto (opz.5388)
heat treated madera oak (opt.5388)

MOBILE DI COMPLEMENTO L 107

ACCESSORY FURNITURE W 107

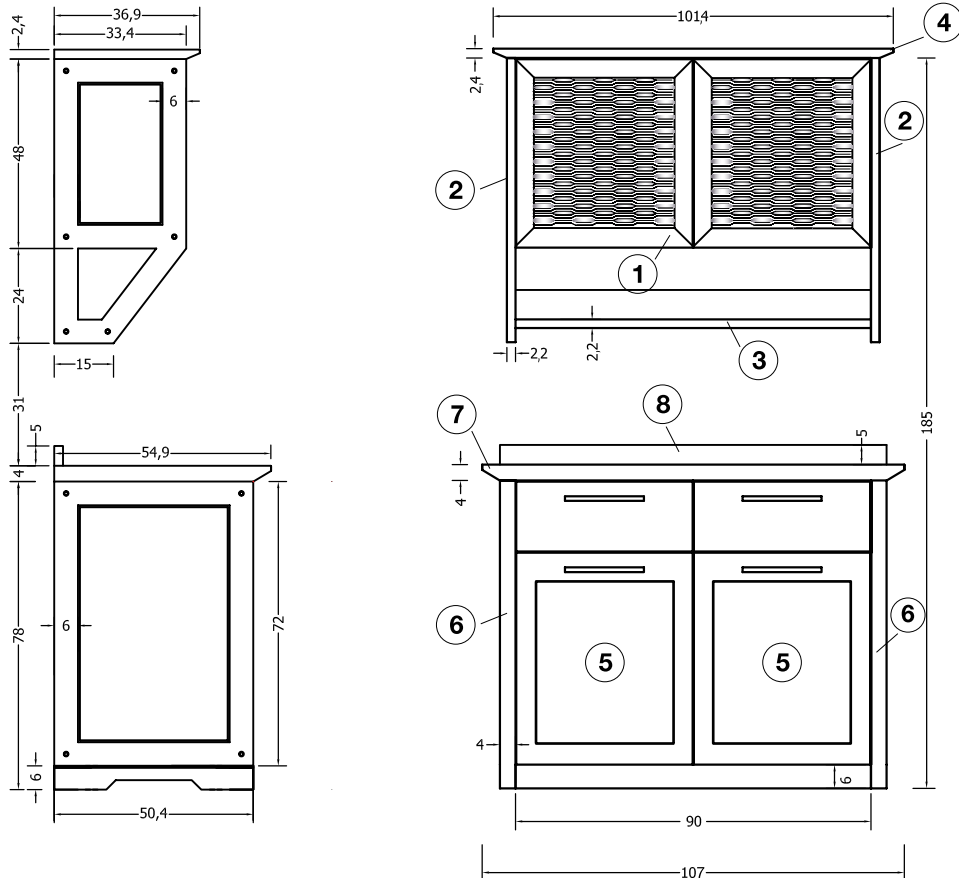

DESCRIZIONE		CODICE		
1) Pensile L 90 H 48 P 31, 2 ante telaio alluminio, presa sul fondo	cad.	G1042900		
2) Fianco pensile sagomato L 33,4 H 72 sp.2,2	cad.	12844625/6		
3) Schienale con mensola L 90 H 10,2 P 17,2	al ml	12844627		
4) Mensola soprapensile con bordo inclinato su 3 lati L 101,4 P 36,9 sp.2,4	al ml	0917358		
5) Base L 90 H 78 P 50,4, 2 cassetti H 12, 2 ante H 60	anta liscia cad.	E4022900		
	anta fresata cad.	E4022900		
6) Fianco sagomato per base H 78 P 50,4 sp.4	impiallacciato liscio cad.	12804631/2		
	laccato fresato cad.	12844631/2		
7) Top con bordo inclinato su 3 lati L 107 P 54,9 sp.4	impiallacciato al ml	TLH405		
	laccato al ml	TLC405		
8) Alzatina H 5 L 98 sp.2,2	impiallacciato al ml	TLH22A		
	laccato al ml	TLC22A		
description		code		
1) Wall unit W 90 H 48 D 31, 2 aluminium frame doors, grip on bottom opening	each	G1042900		
2) Shaped side panel W 33,4 H 72 TH.2,2 for wall unit	each	12844625/6		
3) Back panel with shelf W 90 H 10,2 D 17,2	per lm	12844627		
4) Top mounted shelf with inclined edge on 3 sides W 101,4 D 36,9 TH.2,4	per lm	0917358		
5) Base unit W 90 H 78 D 50,4, 2 drawers H 12, 2 doors H 60	smooth door each	E4022900		
	milled door each	E4022900		
6) Shaped side panel H 78 D 50,4 TH.4	smooth veneered each	12804631/2		
	milled lacquered each	12844631/2		
7) Worktop with inclined edge on 3 sides W 107 D 54,9 TH.4	veneered per lm	TLH405		
	lacquered per lm	TLC405		
8) Backsplash H 5 W 98 TH.2,2	veneered per lm	TLH22A		
	lacquered per lm	TLC22A		

MOBILE DI COMPLEMENTO L 137

ACCESSORY FURNITURE W 137

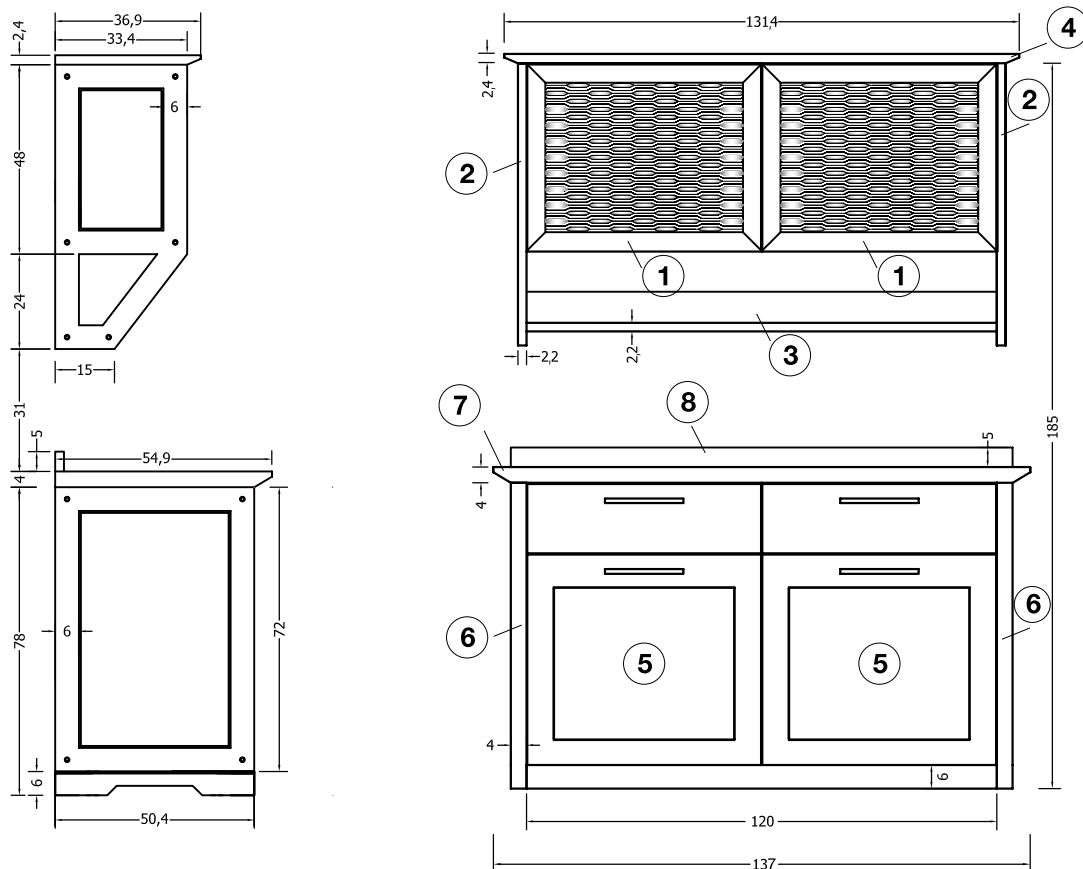

DESCRIZIONE		CODICE		
1) Pensile ribalta L 60 H 48 P 31, anta telaio alluminio, presa sul fondo	cad.	G1122600		
2) Fianco pensile sagomato L 33,4 H 72 sp.2,2	cad.	12844625/6		
3) Schienale con mensola L 120 H 10,2 P 17,5	al ml	12844627		
4) Mensola soprapensile con bordo inclinato su 3 lati L 131,4 P 36,9 sp.2,4	al ml	0917358		
5) Base L 60 H 78 P 50,4, cassetto H 12, anta H 60	anta liscia cad.	E4022681/2		
	anta fresata cad.	E4022681/2		
6) Fianco sagomato per base H 78 P 50,4 sp.4	impiallacciato liscio cad.	12804631/2		
	laccato fresato cad.	12844631/2		
7) Top con bordo inclinato su 3 lati L 137 P 54,9 sp.4	impiallacciato al ml	TLH405		
	laccato al ml	TLC405		
8) Alzatina H 5 L 128 sp.2,2	impiallacciato al ml	TLH22A		
	laccato al ml	TLC22A		
description		code		
1) Wall unit W 60 H 48 D 31, flap door with aluminium frame, grip on bottom opening	each	G1042900		
2) Shaped side panel W 33,4 H 72 TH.2,2 for wall unit	each	12844625/6		
3) Back panel with shelf W 120 H 10,2 D 17,5	per lm	12844627		
4) Top mounted shelf with inclined edge on 3 sides W 131,4 D 36,9 TH.2,4	per lm	0917358		
5) Base unit W 60 H 78 D 50,4, drawer H 12, door H 60	smooth door each	E4022900		
	milled door each	E4022900		
6) Shaped side panel H 78 D 50,4 TH.4	smooth veneered each	12804631/2		
	milled lacquered each	12844631/2		
7) Worktop with inclined edge on 3 sides W 137 D 54,9 TH.4	veneered per lm	TLH405		
	lacquered per lm	TLC405		
8) Backsplash H 5 W 128 TH.2,2	veneered per lm	TLH22A		
	lacquered per lm	TLC22A		

MOBILE DI COMPLEMENTO L 197

ACCESSORY FURNITURE W 197

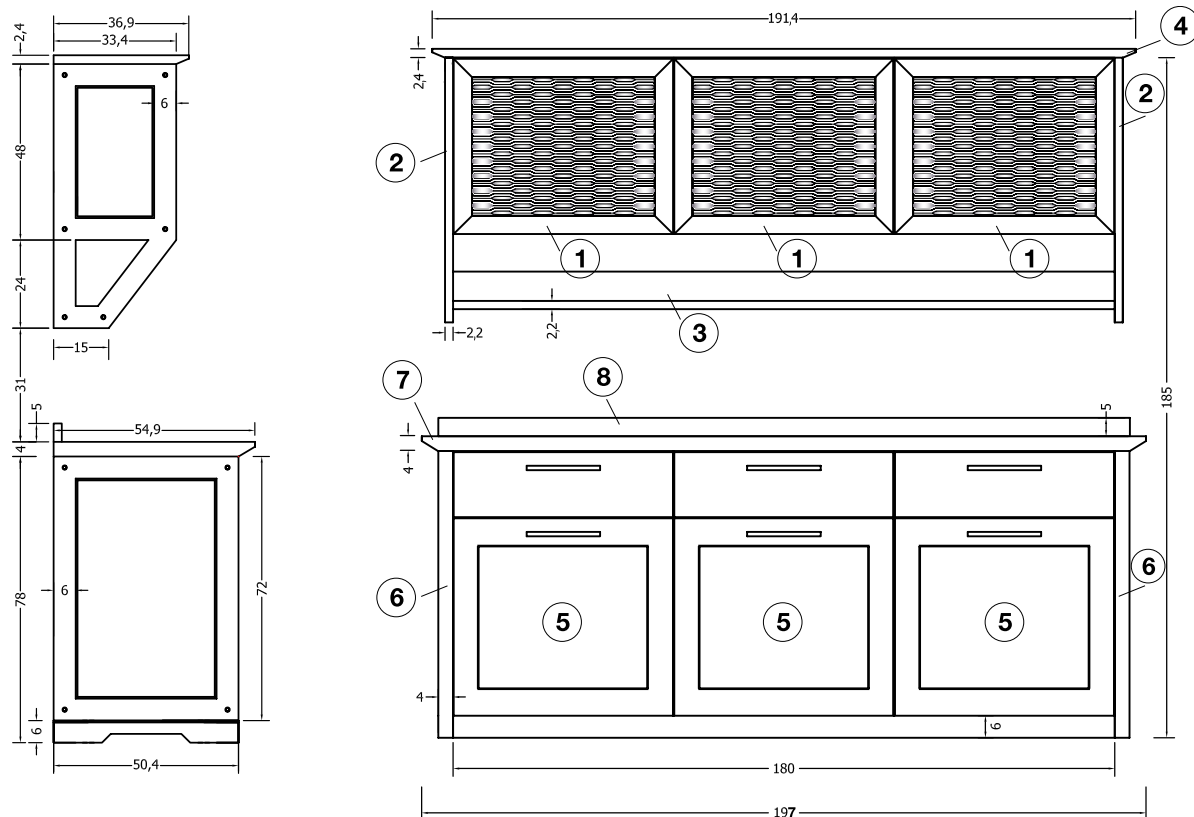

DESCRIZIONE	CODICE			
1) Pensile ribalta L 60 H 48 P 31, anta telaio alluminio con presa sul fondo	cad. G1122600			
2) Fianco pensile sagomato L 33,4 H 72 sp.2,2	cad. 12844625/6			
3) Schienale con mensola L 180 H 10,2 P 17,5	al ml 12844627			
4) Mensola soprapensile con bordo inclinato su 3 lati L 191,4 P 36,9 sp.2,4	al ml 0917358			
5) Base L 60 H 78 P 50,4, cassetto H 12, anta H 60	anta liscia cad. E4022681/2			
	anta fresata cad. E4022681/2			
6) Fianco sagomato per base H 78 P 50,4 sp.4	impiallacciato liscio cad. 12804631/2			
	laccato fresato cad. 12844631/2			
7) Top con bordo inclinato su 3 lati L 197 P 54,9 sp.4	impiallacciato al ml TLH405			
	laccato al ml TLC405			
8) Alzatina H 5 L 188 sp.2,2	impiallacciato al ml TLH22A			
	laccato al ml TLC22A			
description	code			
1) Wall unit W 60 H 48 D 31, flap door with aluminium frame, grip on bottom opening	each G1042900			
2) Shaped side panel W 33,4 H 72 TH.2,2 for wall unit	each 12844625/6			
3) Back panel with shelf W 180 H 10,2 D 17,5	per lm 12844627			
4) Top mounted shelf with inclined edge on 3 sides W 191,4 D 36,9 TH.2,4	per lm 0917358			
5) Base unit W 60 H 78 D 50,4, drawer H 12, door H 60	smooth door each E4022900			
	milled door each E4022900			
6) Shaped side panel H 78 D 50,4 TH.4	smooth veneered each 12804631/2			
	milled lacquered each 12844631/2			
7) Worktop with inclined edge on 3 sides W 197 D 54,9 TH.4	veneered per lm TLH405			
	lacquered per lm TLC405			
8) Backsplash H 5 W 188 TH.2,2	veneered per lm TLH22A			
	lacquered per lm TLC22A			

PANNELLI ACCESSORIATI CON TELAIO ALLUMINIO

FITTED PANELS WITH ALUMINIUM FRAME



COLORI TELAIO E ACCESSORI IN ALLUMINIO

ALUMINIUM FRAME AND ACCESSORIES COLOURS



urban (opt.NU)
urban (opt.NU)

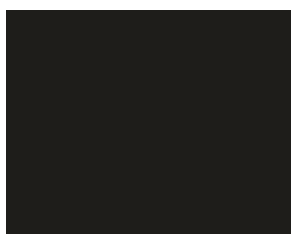

nero (opt.7892)
black (opt.7892)



titanio (opt.414)
titanium (opt.414)

COLORI PANNELLI

COLOURS FOR PANELS

PANNELLO IMPIALLACCIATO

VENEERED PANEL



rovere bianco invecchiato
(opz.5380)
white aged oak (opt.5380)



rovere juta invecchiato
(opz.5381)
jute aged oak (opt.5381)



rovere corteccia invecchiato
(opz.5382)
bark aged oak (opt.5382)



rovere mielato invecchiato
(opz.5383)
honey aged oak (opt.5383)



rovere antracite invecchiato
(opz.5384)
anthracite aged oak
(opt.5384)



rovere argilla invecchiato
(opz.5385)
clay aged oak (opt.5385)

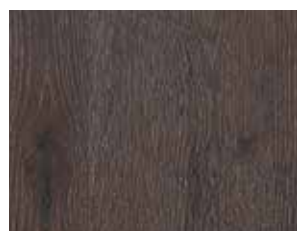

rovere moro invecchiato
(opz.5386)
dark aged oak (opt.5386)



rovere grigio terra (opz.5389)
grey earth oak (opt.5389)



rovere naturale invecchiato
parquettato (opz.5387)
parquet-effect natural
aged oak (opt.5387)



rovere madera termocotto
(opz.5388)
heat treated madera oak
(opt.5388)

PANNELLO FENIX

FENIX PANEL

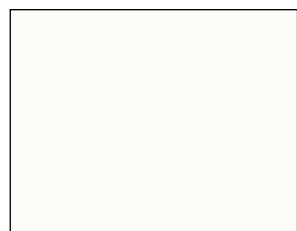

bianco caldo (opz.7446)
warm white (opt.7446)



castoro (opz.8864)
beaver (opt.8864)



nero (opz.7861)
black (opt.7861)



grigio bromo (opz.9628)
bromine grey (opt.9628)



fumo (opz.9629)
smoke (opt.9629)



bianco dover (opz.7449)
dover white (opt.7449)



cacao orinoco (opz.8865)
cocoa orinoco (opt.8865)



beige arizona (opz.7705)
arizona beige (opt.7705)



grigio efeso (opz.9630)
ephesus grey (opt.9630)

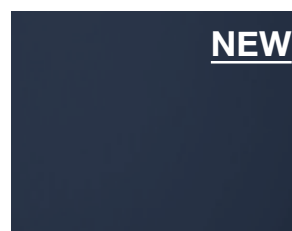

blu fes (opz.8301)
blue fes (opt.8301)



VIVI IL LIVING

LIVE THE LIVING

Vasta gamma di soluzioni e totale modularità per creare nuove composizioni living adatte ad ogni spazio.

Wide range of solutions and total of modules to create new lively furnishing compositions suitable for every kind of space.



LIBRERIA LIVING

LIVING BOOKCASE

La libreria va ad ampliare la gamma living con spessore e carattere. La sua struttura sp.2,5 è perfettamente coordinata alla cucina grazie alla possibilità di integrare le ante del programma Oltre.

N.B.: per una corretta preventivazione ed ordine delle librerie, si consiglia l'uso del programma 3cad Evolution

The bookcase expands the living range with substance and character. His th. 2,5 structure is perfectly coordinated with the kitchen, thanks to the possibility to integrate the door finishes of Oltre program.

Note: we recommend to use the 3cad Evolution software, for having a correct estimate and order.

FINITURE STRUTTURA SP.2,5 - SCHIENA SP.1 STRUCTURE FINISHES TH.2,5 - BACK PANEL TH.1

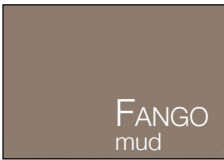
MELAMINICO melamine	 BIANCO white	 VISONE mink	 FANGO mud	 LAVAGNA slate grey	 ARGILLA clay	 CONCHIGLIA shell
LACCATO OPACO matt lacquered	N.B.: per i colori vedi pag.34 Note: for colours see page 34					

FINITURE ANTE DOORS FINISHES

 IMPIALLACCIATO veneered	 FENIX	 LACCATO lacquered
--	---	--



LIVING LO 01



ANTE
doors

IMPIALLACCIATO
veneered

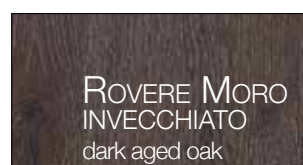

LACCATO OPACO
matt lacquered

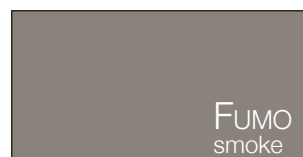

STRUTTURA
carcass

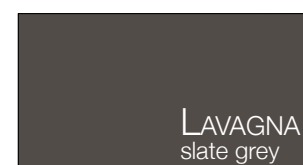

LIVING LO 01

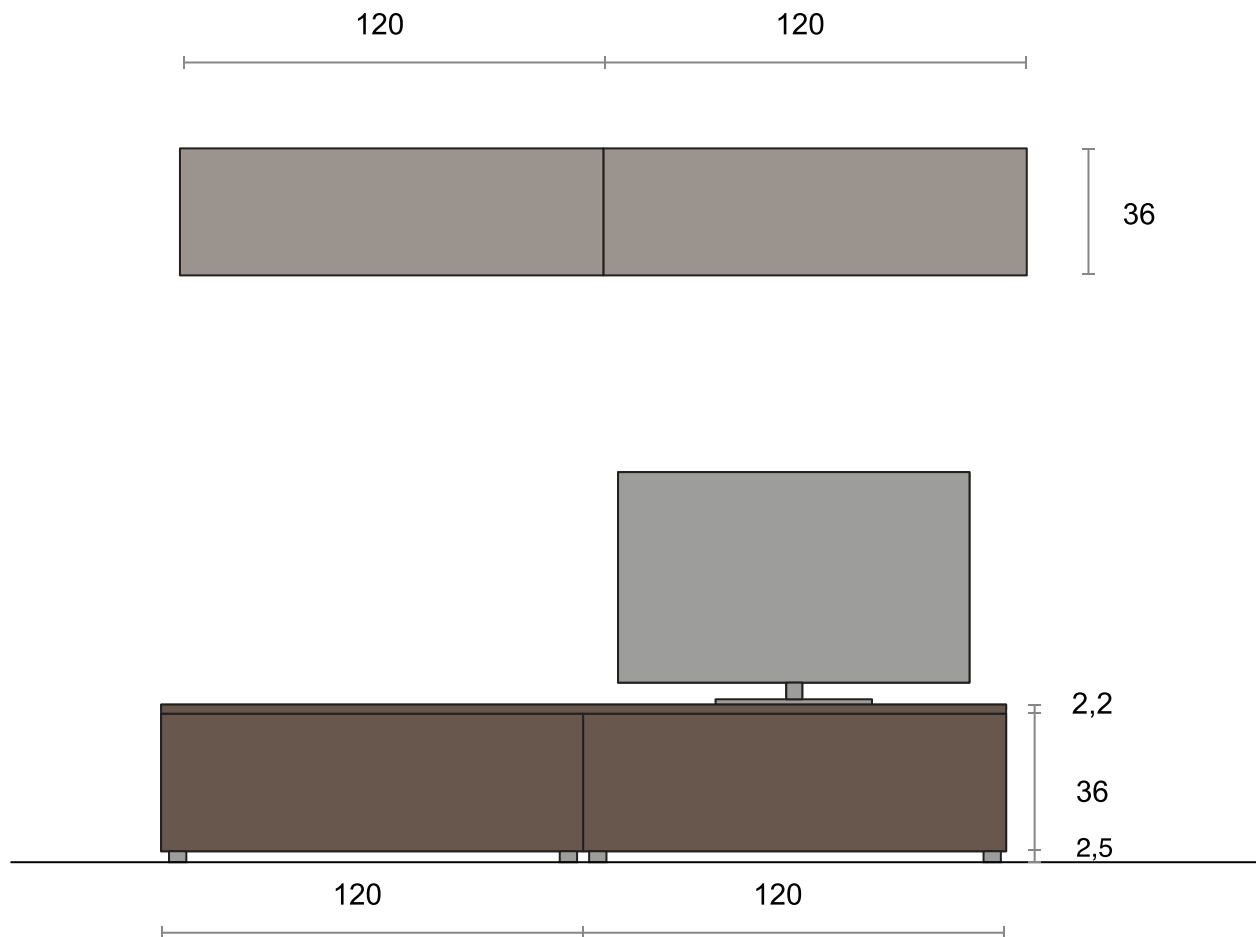

NR. ELEMENTI	DESCRIZIONE	CODICE
2	Base living L 120 H 24 P 50,4, cestone apertura tip-on, 1 fianco come anta	EBL26200
2	Pensile L 120 H 36 P 33,4 apertura tip-on	E210120T
2	Coprifianco H 36 P 31 laccato opaco come anta	T98340
1	Top impiallacciato L 120,2 P 50,4 SP. 2,2	al ml TLH225
2	Asta appendipensili ml 2	08610501
No. of ELEMENTS	DESCRIPTION	CODE
2	Living base unit W 120 H 24 D 50,4, deep drawer tip-on opening, 1 side same as door	EBL26200
2	Wall unit W 120 H 36 D 33,4 flap door opening	E210120T
2	Matt lacquered side panel H 36 D 31, same colour as door	T98340
1	Veneered worktop W 120,2 D 50,4 TH. 2,2	per lm TLH225
2	Wall unit fixing strip lm 2	08610501

LIVING LO 02



ANTE
doors

IMPIALLACCIATO
veneered

ROVERE NATURALE
INVECCHIATO
PARQUETTATO
parquet-effect natural aged oak

LACCATO OPACO
matt lacquered

BIANCO ASSOLUTO
absolute white

LACCATO OPACO
matt lacquered

BISTRO
bistro

STRUTTURA
carcass

FANGO
mud

BIANCO
white

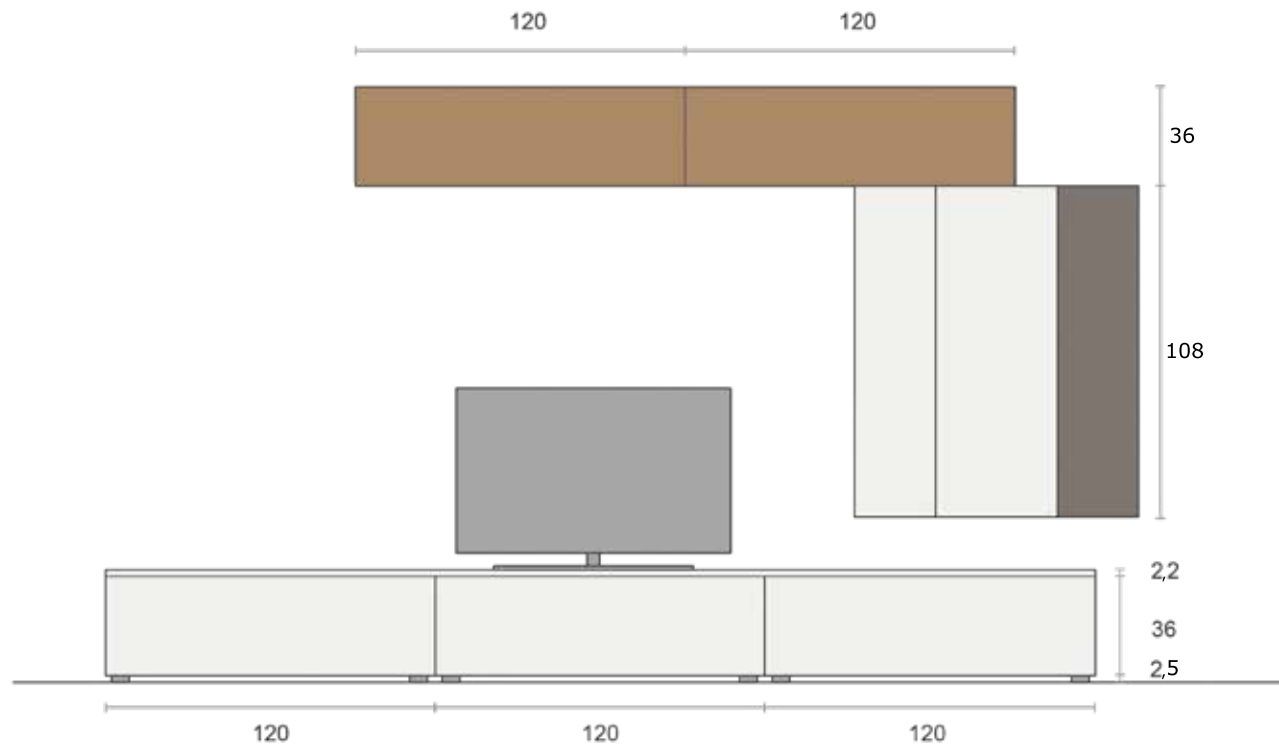

NR. ELEMENTI	DESCRIZIONE	CODICE
2	Pensile L 120 H 36 P 33,4 apertura tip-on, 1 fianco come anta	E210120T
2	Pensile L 30 H 108 P 33,4 apertura push-pull	E2144301/2
2	Coprifianco H 108 P 31 laccato opaco come anta	T98362
1	Pensile L 45 H 108 P 33,4 apertura push-pull	E2144451/2
3	Base living L 120 H 38,5 P 50,4, cestone apertura tip-on	EBL26200
2	Coprifianco H 36 P 48 laccato opaco come anta	T983382
1	Top L 360 P 50,4 SP. 2,2 laccato opaco come anta	al ml TLC225
4	Asta appendipensili ml 2	08610501

No. of ELEMENTS	DESCRIPTION	CODE
2	Wall unit W 120 H 36 D 33,4, tip-on opening, 1 side same as door	E210120T
2	Wall unit W 30 H 108 D 33,4 push-pull opening	E2144301/2
2	Matt lacquered side panel H 108 D 31 same as door	T98362
1	Wall unit W 45 H 108 D 33,4 push-pull opening	E2144451/2
3	Living base unit W 120 H 38,5 D 50,4, deep drawer tip-on opening	EBL26200
2	Matt lacquered side panel H 36 D 48, same as door	T983382
1	Matt lacquered worktop W 360 D 50,4 TH. 2,2 same as door	per lm TLC225
4	Wall unit fixing strip lm 2	08610501

LIVING A SPALLA LO 02



ELEMENTI A GIORNO
LACCATI OPACHI
matt lacquered open units

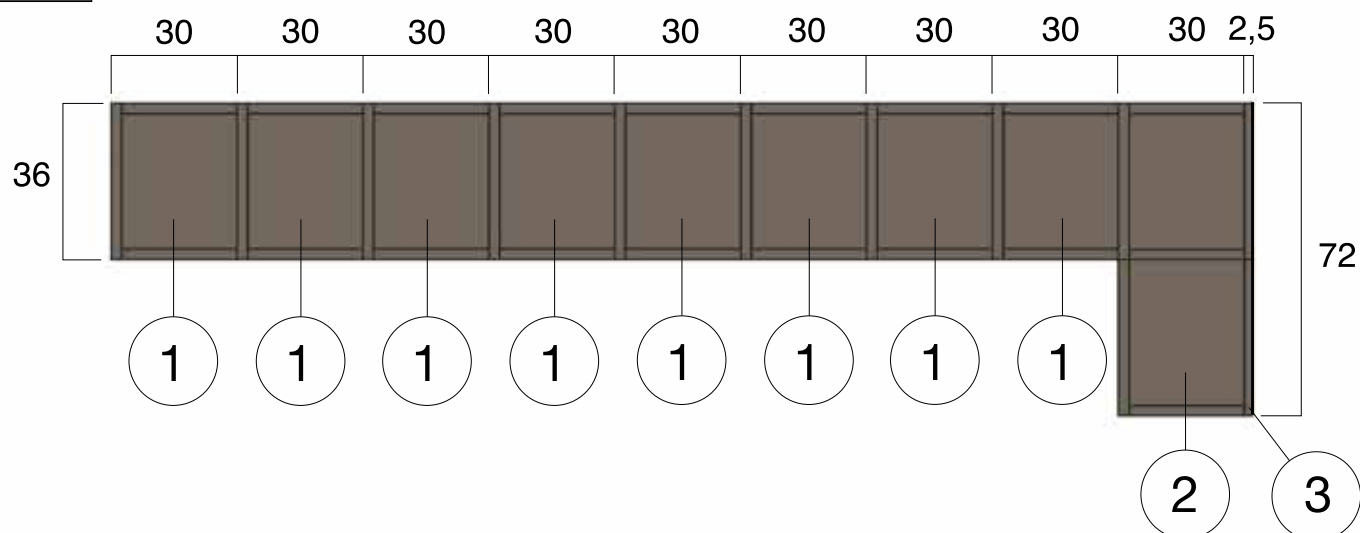

LIVING A SPALLA LO 03



ANTE
doors

SCHIENA
back panel

STRUTTURA
carcass

IMPIALLACCIATO
veneered



MELAMINICO
melamine

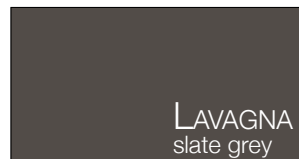

MELAMINICO
melamine



LACCATO OPACO
matt lacquered

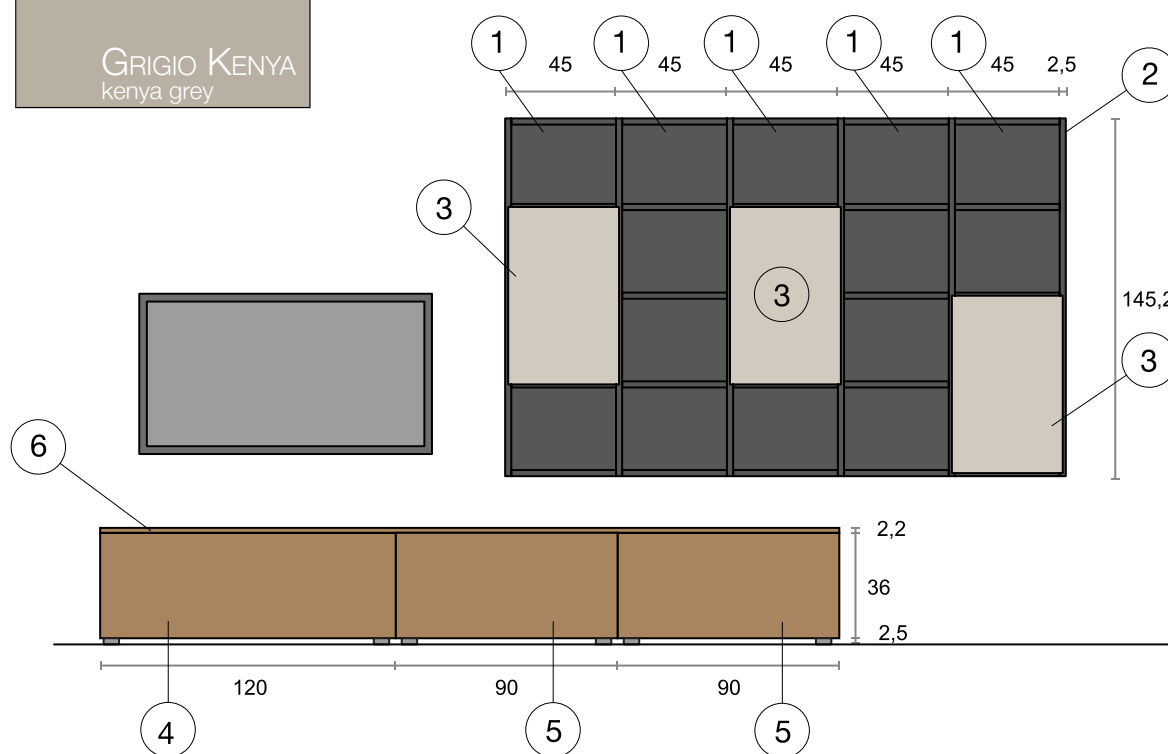
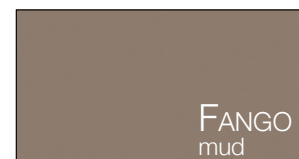

LIVING A SPALLA BIFACCIALE LO 06



ANTA
door

STRUTTURA
carcass

LACCATO OPACO
matt lacquered

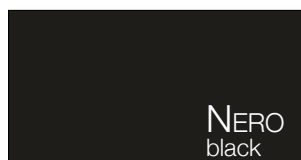

NERO
black

MELAMINICO
melamine

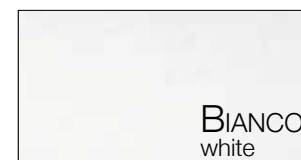

BIANCO
white

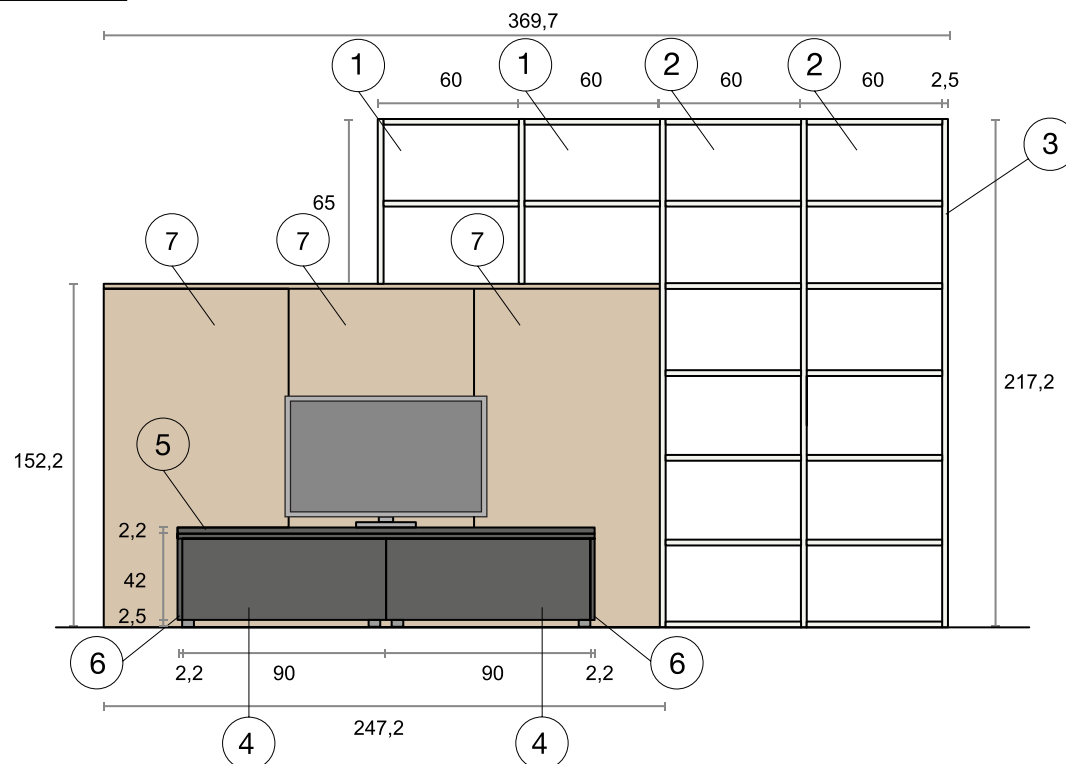

LIVING A SPALLA LO 07



SCHIENA
back panel

STRUTTURA
carcass

LACCATO OPACO
matt lacquered



LACCATO OPACO
matt lacquered

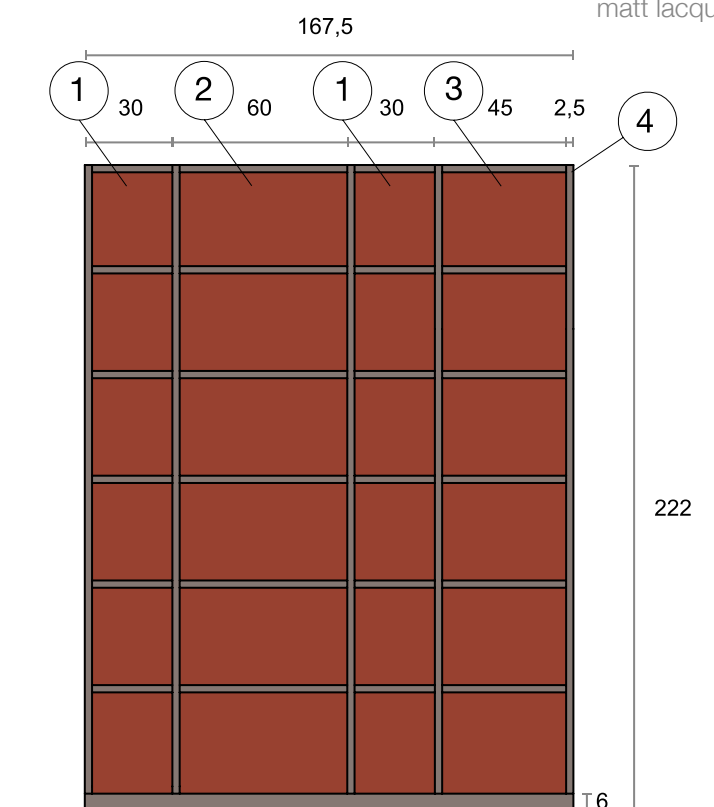
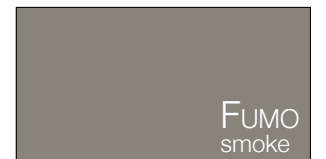

LIVING A SPALLA LO 08



ANTA
door

SCHIENA
back panel

STRUTTURA
carcass

IMPIALLACCIATO
veneered

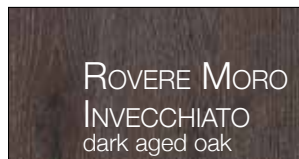

LACCATO OPACO
matt lacquered

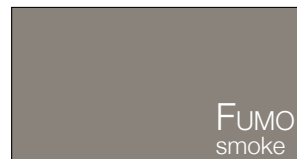

MELAMINICO
melamine

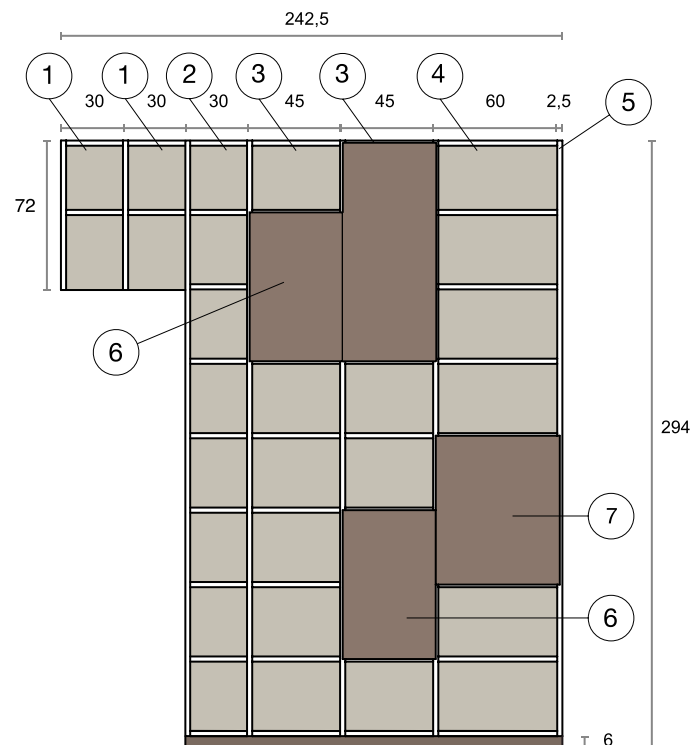
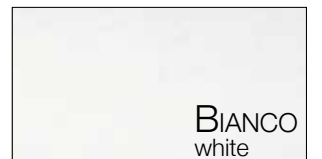

LIVING A SPALLA LO 10



ANTA
door

SCHIENA
back panel

STRUTTURA
carcass

LACCATO OPACO
matt lacquered



LACCATO OPACO
matt lacquered



LACCATO OPACO
matt lacquered

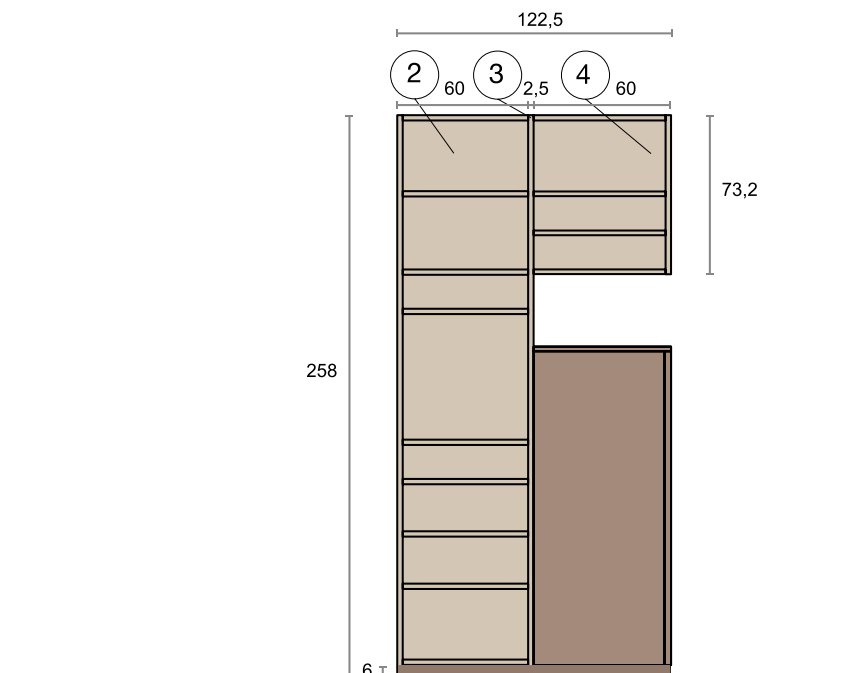
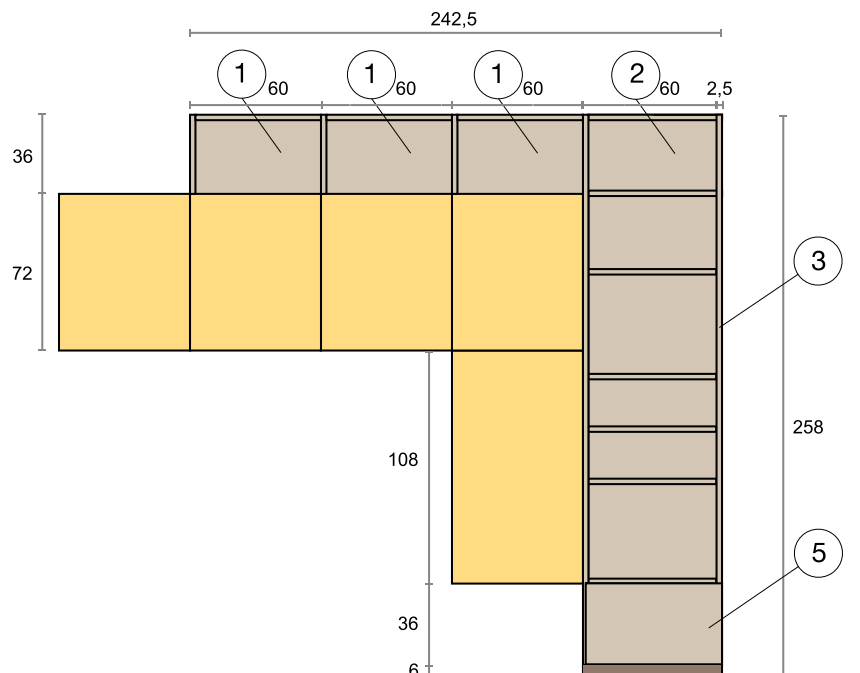

LIVING A SPALLA LO 11



ANTA
door

SCHIENA
back panel

STRUTTURA
carcass

LACCATO OPACO
matt lacquered



LACCATO OPACO
matt lacquered



LACCATO OPACO
matt lacquered

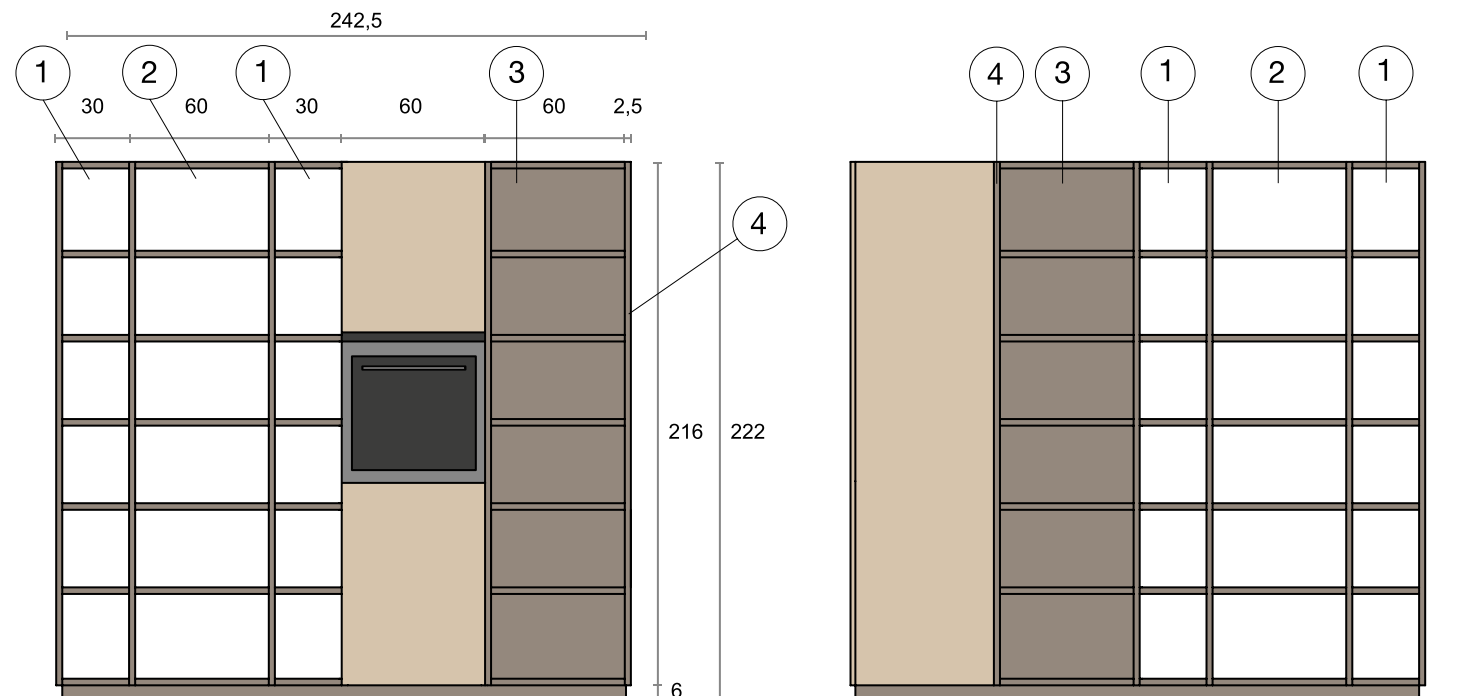

LIVING A SPALLA LO 13



SCHIENA
back panel

LACCATO OPACO
matt lacquered

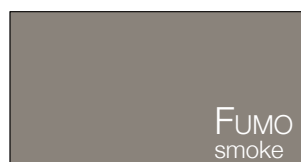

STRUTTURA
carcass

MELAMINICO
melamine

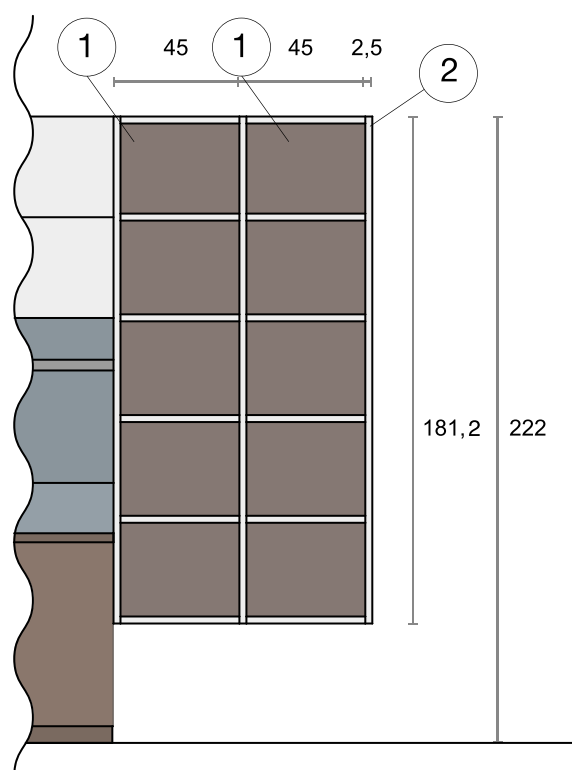

STRUTTURA A PARETE TOWER HI-LINE

TOWER HI-LINE WALL MOUNTED STRUCTURE

Struttura con cremagliera passo 4 cm corredata di piastre per fissaggio carterizzate e regolatori di posizionamento in altezza. Coppia distanziatori amovibili.
Disponibile nelle larghezze L 60 e L 90 entrambe nelle altezze H 270 (regolabile da 268 a 280), H 300 (regolabile da 288 a 300)

Rack system structure gap 4 cm provided with enclosed fixing plates and positioning regulators in height. Removable spacer pair.
Available in L 60 and L 90 widths and both available in heights H 270 (adjustable from 268 to 280), H 300 (adjustable from 288 to 300)

VISTA FRONTALE
FRONT VIEW

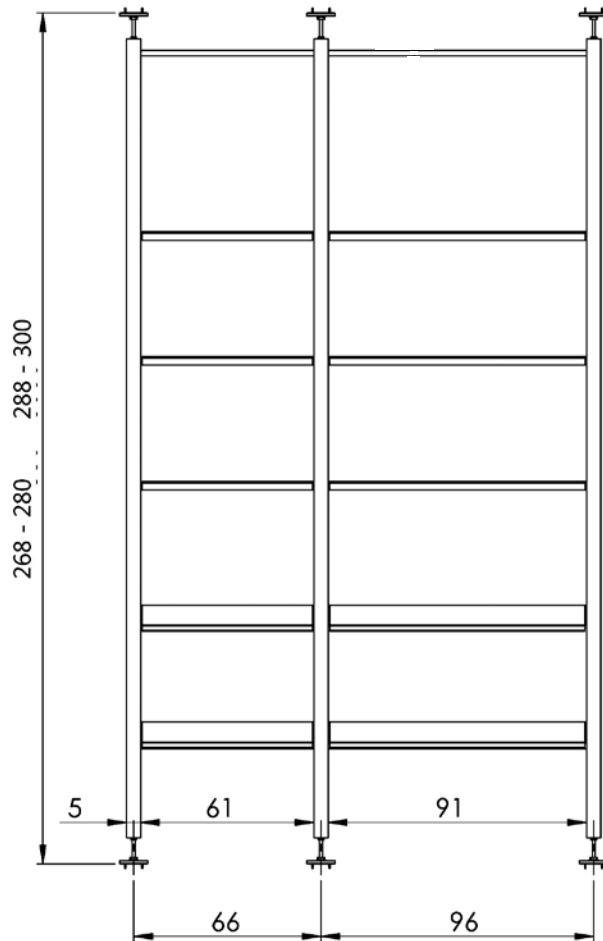

VISTA LATERALE
SIDE VIEW

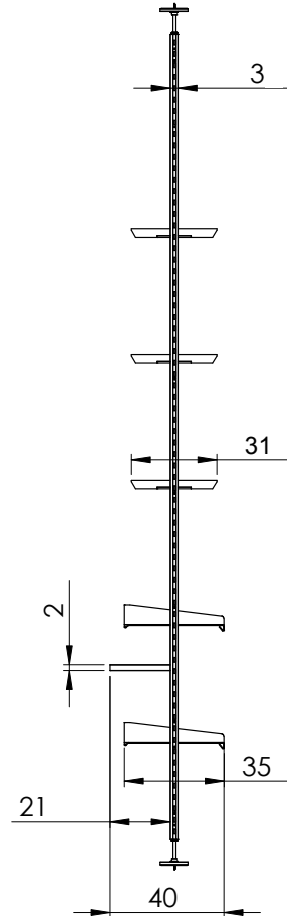

PARTICOLARE

Dettaglio della cremagliera per regolare la posizione delle mensole su tutta l'altezza del telaio

Rack system detail for adjust the position of shelves over the whole heigth of the frame

VISTA SUPERIORE
TOP VIEW

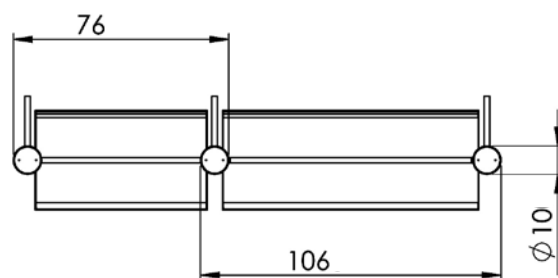

STRUTTURA A PARETE TOWER HI-LINE MODULARITÀ

TOWER HI-LINE WALL MOUNTED STRUCTURE MODULARITY



L 60



L 90

**STRUTTURA A PARETE IN METALLO H 270 (regolabile da 268 a 280)
H 300 (regolabile da 288 a 300)**

Composto da:

- 2 cremagliere corredate di piastre per fissaggio
- 2 distanziatori amovibili (60 - 90)

Metal wall mounted structure H 270 (adjustable from 268 to 280)
H 300 (adjustable from 288 to 300)

Consist of:

- 2 racks equipped provided with enclosed fixing plates
- 2 removable spacers (60 - 90)

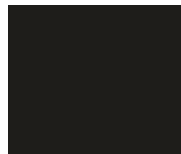

nero (opz.AL11)
black (opt.AL11)



titanio (opz.AL12)
titanium (opt.AL12)

H 270

L 60 cod.0890400

L 90 cod.0890405

H 300

L 60 cod.0890410

L 90 cod.0890415



**MONTANTE A PARETE IN METALLO H 270 (regolabile da 268 a 280)
H 300 (regolabile da 288 a 300)**

Composto da:

- 1 cremagliera corredata di piastre per fissaggio
- 2 distanziatori amovibili (60 - 90)

Metal wall mounted pillar H 270 (adjustable from 268 to 280)
H 300 (adjustable from 288 to 300)

Consist of:

- 1 rack equipped provided with enclosed fixing plates
- 2 removable spacers (60 - 90)



nero (opz.AL11)
black (opt.AL11)



titanio (opz.AL12)
titanium (opt.AL12)

H 270

L 60 cod.0890402

L 90 cod.0890407

H 300

L 60 cod.0890412

L 90 cod.0890417



STRUTTURA AD ISOLA TOWER HI-LINE

MINK MATT ACRYLIC BOOKCASE TOWER HI-LINE ISLAND LIVING AREA ELEMENTS STRUCTURE

Struttura con cremagliera passo 4 cm corredata di piastre per fissaggio carterizzate e regolatori di posizionamento in altezza. Coppia distanziatori amovibili.

Disponibile nelle larghezze L 60 e L 90 entrambe nell' altezza H 270 (regolabile da 268 a 280)

Rack system structure gap 4 cm provided with enclosed fixing plates and positioning regulators in height. Removable spacer pair.

Available in L 60 and L 90 widths and both available in height H 270 (adjustable from 268 to 280)

VISTA FRONTALE
FRONT VIEW

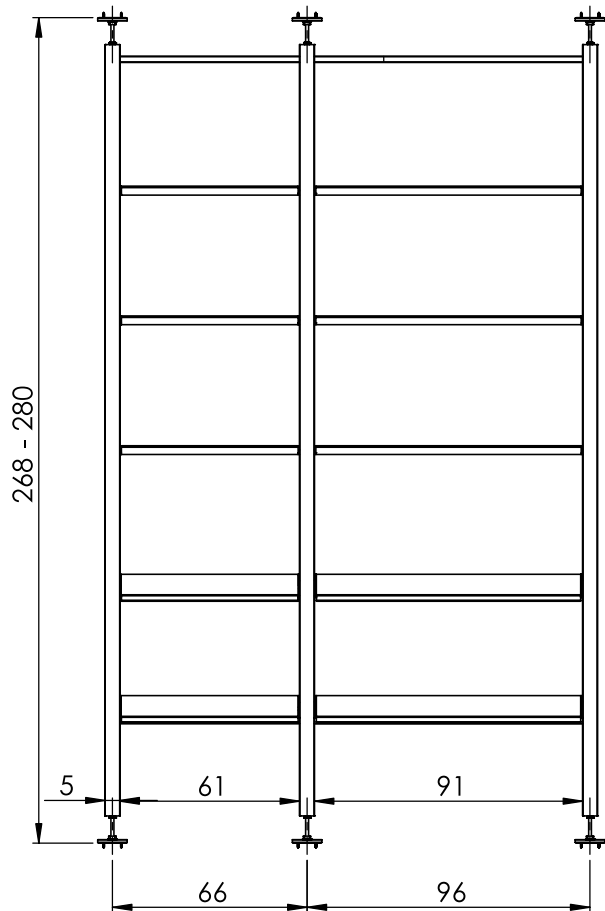

VISTA LATERALE
SIDE VIEW

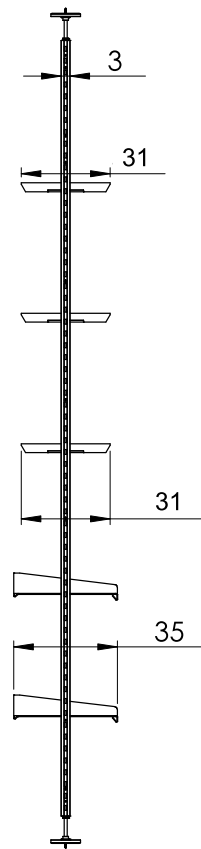

PARTICOLARE

Dettaglio della cremagliera per regolare la posizione dei ripiani su tutta l'altezza del telaio

Rack system detail for adjust the position of shelves over the whole height of the frame

VISTA SUPERIORE
TOP VIEW

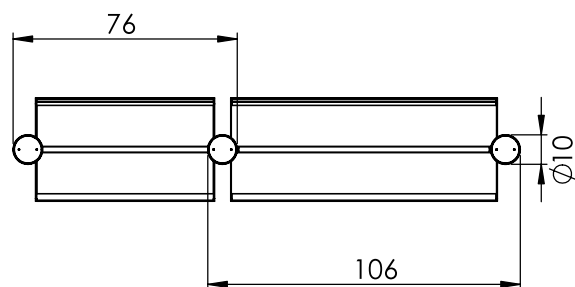

STRUTTURA CONTENITIVA AD ISOLA TOWER HI-LINE MODULARITÀ

TOWER HI-LINE ISLAND CONTAINMENT STRUCTURE MODULARITY

STRUTTURA AD ISOLA IN METALLO H 270 (regolabile da 268 a 280)

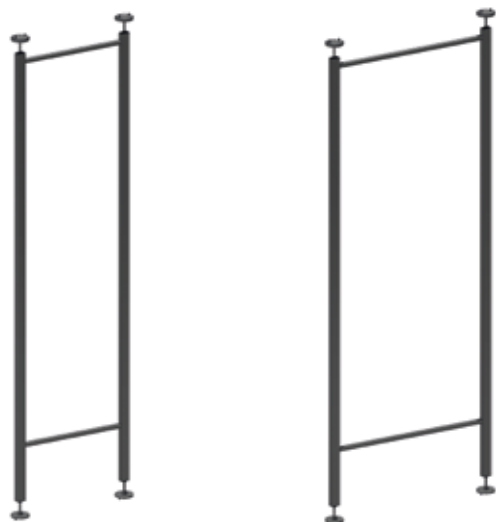

L 60

L 90

Composto da:

- 2 cremagliere corredate di piastre per fissaggio
- 2 distanziatori amovibili (60 - 90)

Metal island structure H 270 (adjustable from 268 to 280)

Consist of:

- 2 racks equipped provided with enclosed fixing plates
- 2 removable spacers (60 - 90)

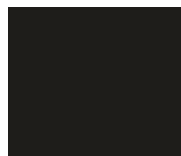

nero (opz.AL11)
black (opt.AL11)



titanio (opz.AL12)
titanium (opt.AL12)

L 60 cod.0890400

L 90 cod.0890405

MONTANTE AD ISOLA IN METALLO H 270 (regolabile da 268 a 280)



Composto da:

- 1 cremagliera corredata di piastre per fissaggio
- 2 distanziatori amovibili (60 - 90)

Metal island pilar H 270 (adjustable from 268 to 280)

Consist of:

- 1 rack equipped provided with enclosed fixing plates
- 2 removable spacers (60 - 90)



nero (opz.AL11)
black (opt.AL11)



titanio (opz.AL12)
titanium (opt.AL12)

L 60 cod.0890402

L 90 cod.0890407



MENSOLE PER STRUTTURA TOWER HI-LINE

SHELVES FOR TOWER HI-LINE STRUCTURE

MENSOLA IN ALLUMINIO L 60-90 P 35 completa di agganci per cremagliera

Aluminium shelf W 60-90 D 35 complete of rack hooks

Colori disponibili: nero e titanio

Available colours: black and titanium

N.B.: per la corretta stabilità inserire almeno 4 mensole per modulo

Note: to guarantee the correct stability of the structure, insert at least 4 shelves for any module

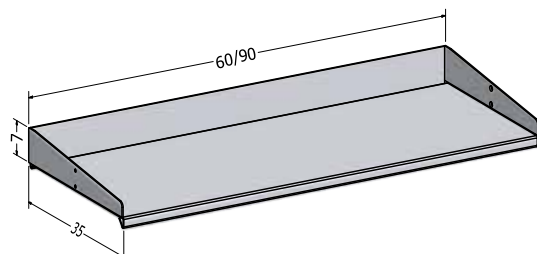

nero (opz.AL11)
black (opt.AL11)



titanio (opz.AL12)
titanium (opt.AL12)

L 60 cod.0890425

L 90 cod.0890426

MENSOLA SAGOMATA PER STRUTTURA A PARETE L 60-90 P 31 completa di agganci per cremagliera

shaped shelf for wall mounted structure W 60-90 D 31 complete of rack hooks

Finiture disponibili: fenix, impiallacciata (per colori vedi pag.400)

Available finishes: fenix, veneered (for colours see page 400)

N.B.: per la corretta stabilità inserire almeno 4 mensole per modulo

Note: to guarantee the correct stability of the structure, insert at least 4 shelves for any module

FENIX

L 60 cod.0890432

L 90 cod.0890442

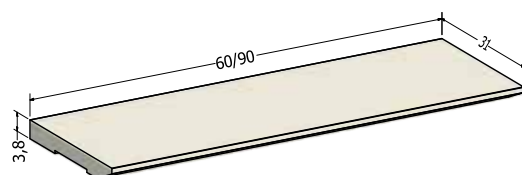

IMPIALLACCIATA - VENEERED

L 60 cod.0890436

L 90 cod.0890446

LACCATO OPACO - MATT LACQURED

L 60 cod.0890438

L 90 cod.0890448

MENSOLA SAGOMATA PER STRUTTURA A ISOLA L 60-90 P 31 completa di agganci per cremagliera

shaped shelf for island structure W 60-90 D 31 complete of rack hooks

Finiture disponibili: fenix, impiallacciata (per colori vedi pag.400)

Available finishes: fenix, veneered (for colours see page 400)

N.B.: per la corretta stabilità inserire almeno 4 mensole per modulo

Note: to guarantee the correct stability of the structure, insert at least 4 shelves for any module

FENIX

L 60 cod.0890431

L 90 cod.0890441

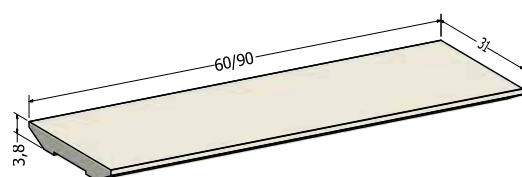

IMPIALLACCIATA - VENEERED

L 60 cod.0890435

L 90 cod.0890445

LACCATO OPACO - MATT LACQURED

L 60 cod.0890437

L 90 cod.0890447

FINITURE MENSOLE ED ELEMENTI TOWER HI-LINE

SHELVES AND ELEMENTS FINISHES FOR TOWER HI-LINE

FENIX (solo per mensole - only for shelves)

<p>bianco caldo (opz.7446) warm white (opt.7446)</p>	<p>castoro (opz.8864) beaver (opt.8864)</p>	<p>nero (opz.7861) black (opt.7861)</p>	<p>grigio bromo (opz.9628) bromine grey (opt.9628)</p>	<p>fumo (opz.9629) smoke (opt.9629)</p>
<p>NEW</p> <p>bianco dover (opz.7449) dover white (opt.7449)</p>	<p>NEW</p> <p>cacao orinoco (opz.8865) cocoa orinoco (opt.8865)</p>	<p>NEW</p> <p>beige arizona (opz.7705) arizona beige (opt.7705)</p>	<p>NEW</p> <p>grigio efeso (opz.9630) ephesus grey (opt.9630)</p>	<p>NEW</p> <p>blu fes (opz.8301) blue fes (opt.8301)</p>

IMPIALLACCIATI

VENEERED

<p>rovere bianco invecchiato (opz.5380) white aged oak (opt.5380)</p>	<p>rovere juta invecchiato (opz.5381) jute aged oak (opt.5381)</p>	<p>rovere corteccia invecchiato (opz.5382) bark aged oak (opt.5382)</p>	<p>rovere mielato invecchiato (opz.5383) honey aged oak (opt.5383)</p>	<p>rovere antracite invecchiato (opz.5384) anthracite aged oak (opt.5384)</p>	<p>rovere argilla invecchiato (opz.5385) clay aged oak (opt.5385)</p>
<p>rovere moro invecchiato (opz.5386) dark aged oak (opt.5386)</p>	<p>rovere naturale invecchiato parquettato (opz.5387) parquet-effect natural aged oak (opt.5387)</p>	<p>rovere madera termocotto (opz.5388) heat treated madera oak (opt.5388)</p>	<p>rovere grigio terra (opz.5389) grey earth oak (opt.5389)</p>		

LACCATI OPACHI

MATT LACQUERED

<p>grigio traffico (opz.9511) traffic grey (opt.9511)</p>	<p>verde lichene (opz.8463) lichen green (opt.8463)</p>	<p>creta (opz.9515) clay (opt.9515)</p>	<p>bianco caldo (opz.7401) warm white (opt.7401)</p>	<p>fumo (opz.9531) smoke (opt.9531)</p>	<p>nero (opz.7892) black (opt.7892)</p>
<p>conchiglia (opz.7403) shell (opt.7403)</p>	<p>argilla (opz.9503) clay (opt.9503)</p>	<p>castoro (opz.8907) beaver (opt.8907)</p>	<p>bistro (opz.9535) bistro (opt.9535)</p>	<p>terra di siena (opz.8161) siena earth (opt.8161)</p>	<p>blu fiordaliso (opz.8377) cornflower blue (opt.8377)</p>
<p>grigio bromo (opz.9533) bromine grey (opt.9533)</p>	<p>grigio kenya (opz.9501) kenya grey (opt.9501)</p>	<p>verde positano (opz.8471) positano green (opt.8471)</p>	<p>giallo ambra (opz.327S) amber yellow (opt.327S)</p>	<p>rosso toscano (opz.8157) tuscan red (opt.8157)</p>	<p>lino (opz.9513) linen (opt.9513)</p>



STRUTTURA A PARETE TOWER HI-LINE ESEMPIO DI COMPOSIZIONE

TOWER HI-LINE WALL MOUNTED STRUCTURE COMPOSITION EXAMPLE

ESEMPIO COMPOSIZIONE COLORE NERO L 197
 EXAMPLE OF COMPOSITION BLACK FINISH L 197

DESCRIZIONE / DESCRIPTION		
N°1 struttura a parete L 90 H 300 P 5 N°1 wall mounted structure W 90 H 300 D 5		
N°1 montante a parete L 90 H 300 P 5 N°1 wall mounted pillar W 90 H 300 D 5		
N°4 mensole in alluminio L 90 P 35 N°4 aluminim shelves W 90 D 35		
N°4 mensole laccate a parete L 90 P 35 N°4 lacquered shelves wall mounting W 90 D 35		
N°2 pensili laccati a ribalta tip-on L 90 H 36 P 33,4 N°2 lacquered wall units flap door opening W 90 H 36 D 33,4		

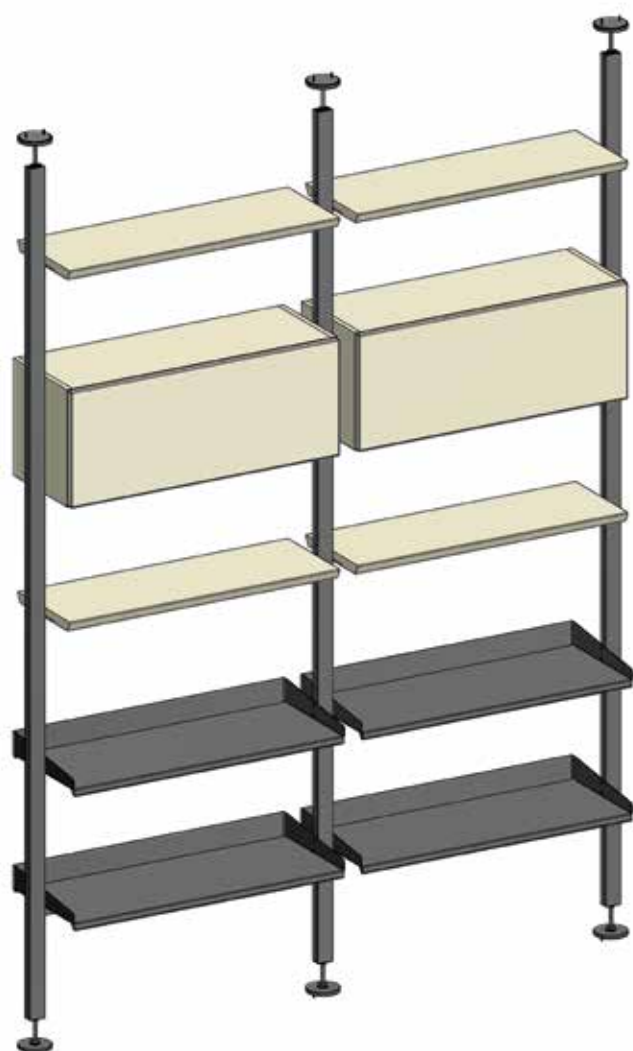

Vista frontale
 Front view

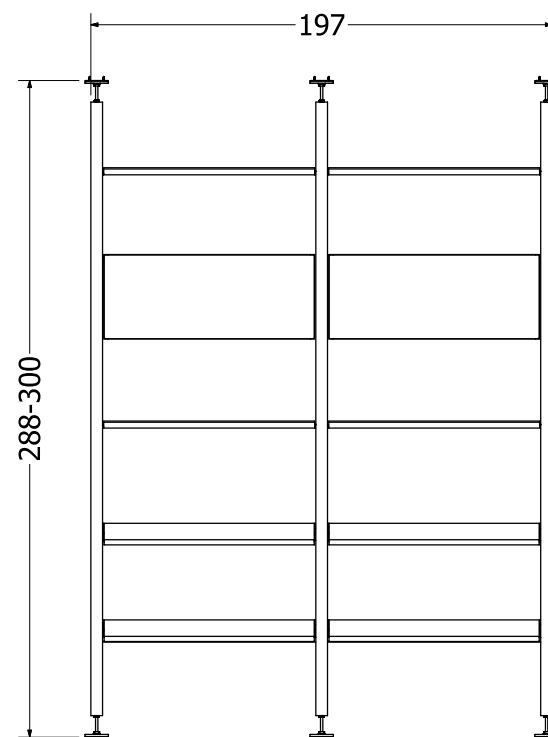

Vista superiore
 Top view

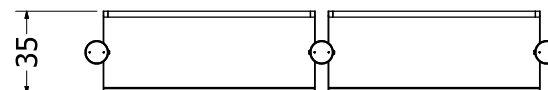

STRUTTURA AD ISOLA TOWER HI-LINE ESEMPIO DI COMPOSIZIONE

TOWER HI-LINE ISLAND STRUCTURE COMPOSITION EXAMPLE

ESEMPIO COMPOSIZIONE COLORE NERO L 233
 EXAMPLE OF COMPOSITION BLACK FINISH

DESCRIZIONE / DESCRIPTION		
N°1 struttura ad isola L 60 H 270 P 5 N°1 metal island structure W 60 H 270 D 5		
N°1 montante ad isola L 90 H 270 P 5 N°1 metal island pillar W 90 H 270 D 5		
N°1 montante ad isola L 60 H 270 P 5 N°1 metal island pillar W 60 H 270 D 5		
N°4 mensole in alluminio L 60 P 35 N°4 aluminium shelves W 60 D 35		
N°2 mensole in alluminio L 90 P 35 N°2 aluminium shelves W 90 D 35		
N°6 mensole impialacciate isola L 60 P 35 N°6 veneered shelves for island W 60 D 35		
N°2 mensole impialacciate isola L 90 P 35 N°2 veneered shelves for island W 90 D 35		

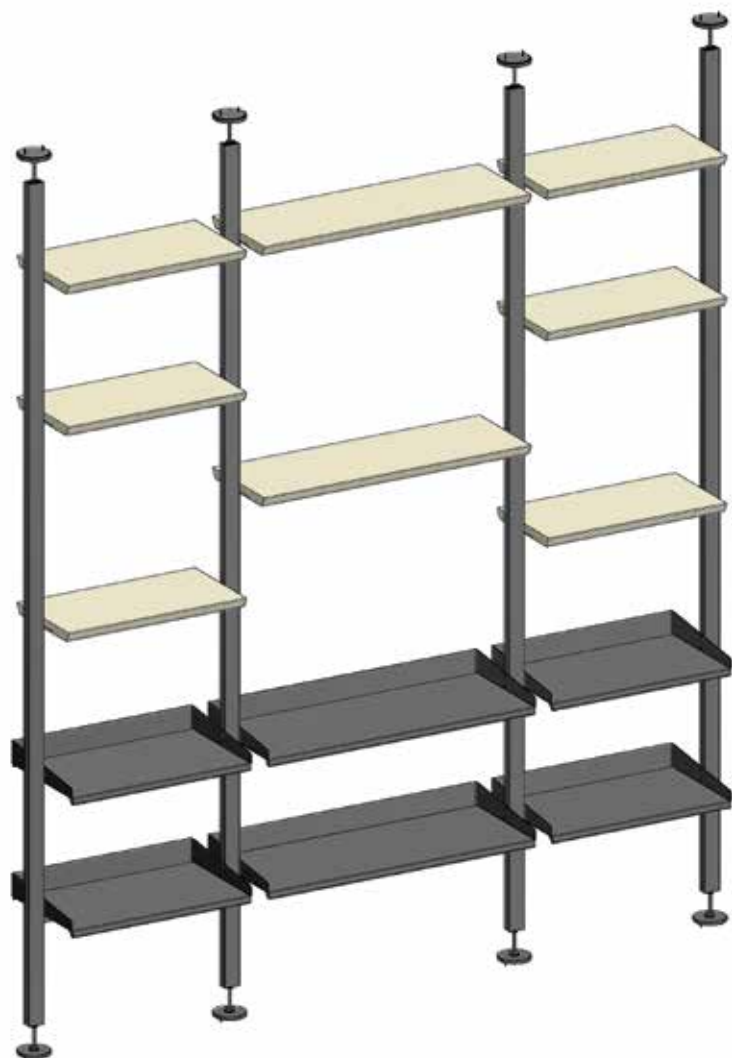

Vista frontale
Front view

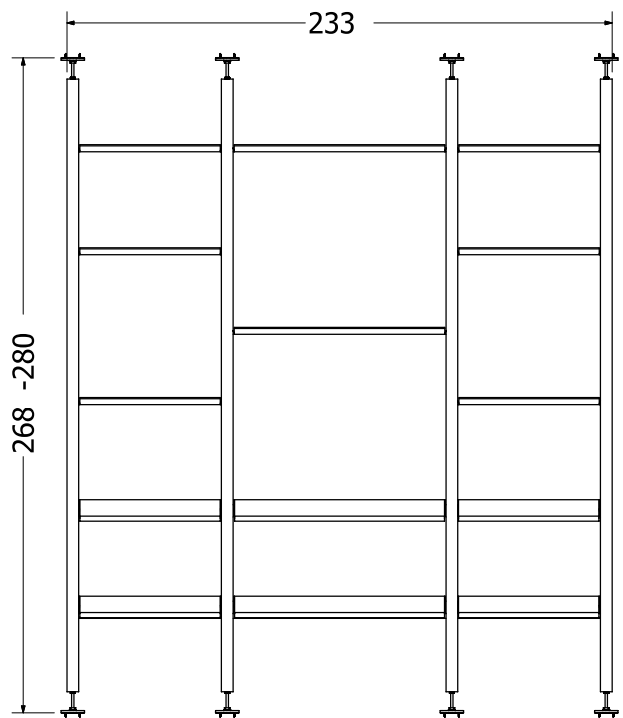

Vista superiore
Top view

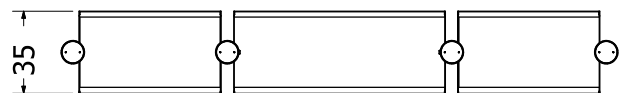

COMPOSIZIONE L 423

COMPOSITION W 423



COMPOSIZIONE L 420

COMPOSITION W 420



COMPOSIZIONE L 423

COMPOSITION W 423

COMPONENTI COMPONENTS

Colonna 60 H 222 frigo-freezer 315 classe A+

60 cm column H 222 fridge-freezer 315 class "A+"

Colonna 60 H 222 forno multifunzione inox

60 cm column H 222 for stainless steel multifunctional oven

Base 60

60 cm base unit

Piano cottura 75 5 gas inox con valvola

75 cm stainless steel hob with 5 burners with safety valve

Base 90 2 cassetti e cestone predisposta piano cottura

90 cm base unit with 2 drawers and deep drawers configured for hob

Base 60

60 cm base unit

Sottolavello 90

90 cm sink unit

Lavello ad incasso 86 x 50 1 vasca inox

86x50 cm built-in sink with 1 stainless steel bowl

Top 300 P 61 in laminato H 4

300 cm laminate worktop D 61 H 4

Pensile 60 H 72

60 cm wall unit H 72

Cappa 90 "STILO" inox

90 cm "STILO" stainless steel hood

Pensile 60 H 72

60 cm wall unit H 72

Scolapiatti 90 H 72

90 cm plate rack H 72

Asta appendispensili ml 4

4 lm wall unit fixing strip

(Elettrodomestici Hotpoint)
(Hotpoint appliances)

NECK

Impiallacciata Veneered

Fenix

Laccato Opaco Matt Lacquered

Laccato Lucido Glossy Lacquered

Laccato Vintage Vintage Lacquered

Vetro Satinato Satin Glass

Vetro Lucido Glossy Glass

LUX

Impiallacciata Veneered

Fenix

Laccato Opaco Matt Lacquered

Laccato Lucido Glossy Lacquered

Laccato Vintage Vintage Lacquered

Vetro Satinato Satin Glass

Vetro Lucido Glossy Glass

COMPOSIZIONE L 420

COMPOSITION W 420

COMPONENTI COMPONENTS

Colonna 60 H 222 frigo-freezer 315 classe A+

60 cm column H 222 fridge-freezer 315 class "A+"

Colonna 60 H 222 forno multifunzione inox

60 cm column H 222 for stainless steel multifunctional oven

Base 60

60 cm base unit

Piano cottura 75 5 gas inox con valvola

75 cm stainless steel hob with 5 burners with safety valve

Base 90 2 cassetti e cestone predisposta piano cottura

90 cm base unit with 2 drawers and deep drawers configured for hob

Base 60

60 cm base unit

Sottolavello 90

90 cm sink unit

Lavello ad incasso 86 x 50 1 vasca inox

86x50 cm built-in sink with 1 stainless steel bowl

Top 300 P 61 in laminato H 4

300 cm laminate worktop D 61 H 4

Pensile 60 H 72

60 cm wall unit H 72

Cappa 90 "STILO" inox

90 cm "STILO" stainless steel hood

Pensile 60 H 72

60 cm wall unit H 72

Scolapiatti 90 H 72

90 cm plate rack H 72

Asta appendispensili ml 4

4 lm wall unit fixing strip

(Elettrodomestici Hotpoint)
(Hotpoint appliances)

VERSIONI VERSIONS

BRIDGE

Impiallacciata Veneered

Fenix

Laccato Opaco Matt Lacquered

Laccato Lucido Glossy Lacquered

Laccato Vintage Vintage Lacquered