

DC020



Forte, moderna, tecnologicamente avanzata. Una cucina che fa della materia pura il suo asso vincente. Composizioni fortemente scenografiche e dettagli studiati per esaltare al meglio il vivere di oggi.

Strong, modern, technologically advanced. A kitchen featuring pure matter as its winning ace. Strongly scenic compositions and details designed to bring out the best of today's life.

Neck

ANTA SQUADRATA CON MANIGLIA A GOLA

SQUARE DOOR WITH FINGER
RAIL OPENING

L'ANTA SQUADRATA SI ABBINA
ALLA GOLA AD "ELLE" PER CREARE
LA COLLEZIONE NECK. UN'ANTA
PRESENTATA IN UN'AMPIA GAMMA
DI COLORI E FINITURE CHE POSSONO
PERSONALIZZARE LA GOLA.

THE SQUARE DOOR MATCHES WITH THE "L" FINGER
RAIL OPENING TO CREATE THE NECK COLLECTION.
THE DOOR IS PRESENTED ON A WIDE RANGE OF
COLOURS AND FINISHES THAT CAN CUSTOMIZE THE
FINGER RAIL OPENING.





Apertura con gola / Opening by finger rail

Neck



gola tipo "elle"
"elle" type finger rail

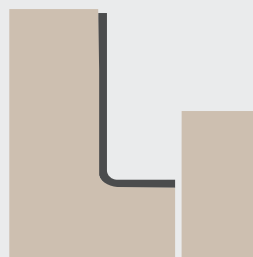

Anta neck
per gola tipo "elle"
"neck" door for "elle"
type finger rail

Finiture gole / Finger rails finishes

**Finiture gole verniciate
a polvere opache**
Matt finger rails
powder coated finishes

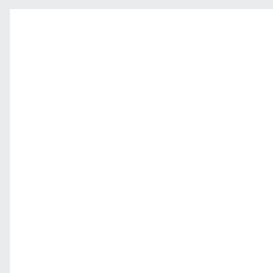

bianco assoluto (opz.740S)
absolute white (opt.740S)

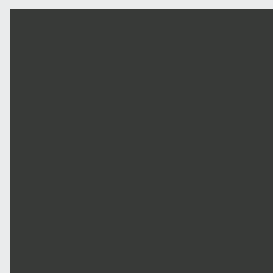

bistro (opz.9535)
bistro (opt.9535)

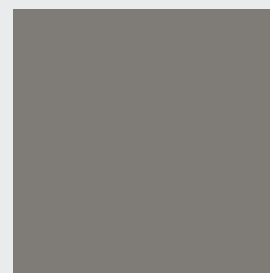

fumo (opz.9531)
smoke (opt.9531)

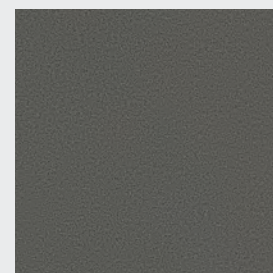

silver dark (opz.9507)
dark silver (opt.9507)

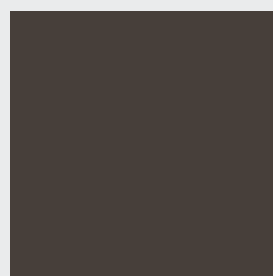

ghisa (opz.9509)
cast iron (opt.9509)



grigio selce (opz.SEL)
flint grey (opt.SEL)

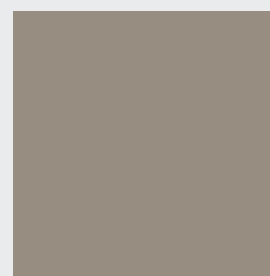

castoro (opz.8907)
beaver (opt.8907)

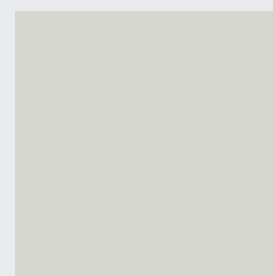

cenere (opz.9547)
ash (opt.9547)

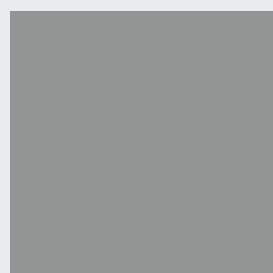

argilla (opz.9503)
clay (opt.9503)

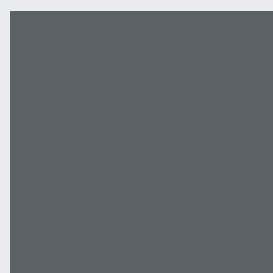

grigio bromo (opz.9533)
bromine grey (opt.9533)

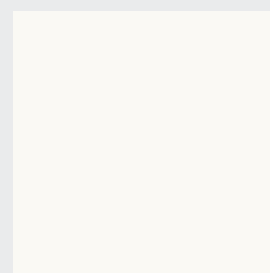

bianco caldo (opz.7401)
warm white (opt.7401)

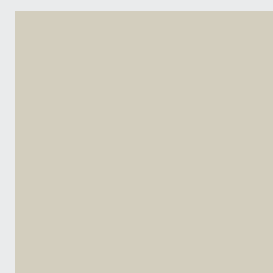

conchiglia (opz.7403)
shell (opt.7403)

Finiture gole / Finger rails finishes

**Finiture gole verniciate
a polvere opache
colori ossidati**
Matt finger rails
powder coated finishes
oxidized colours



ossido ottone
(opz.MEOT)
oxidized brass
(opt.MEOT)



ossido rame
(opz.MERM)
oxidized copper
(opt.MERM)



nero (opz.7892)
black (opt.7892)

N.B.: ABBINAMENTO CONSIGLIATO
CON L'ANTA ACCIAIO NERO EFFETTO OSSIDATO
NOTE: BEST MATCHING WITH THE
BLACK STEEL OXIDIZED EFFECT

Finiture gole spazzolate
Finger rails brushed finishes



urban ossidato (opz.NUL)
urban oxidized (opt.NUL)



brill (opz.412)
brill (opt.412)



bronzio anticato
(opz.8909)
antique bronze
(opt.8909)

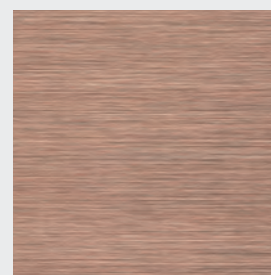

rame anticato (opz.422)
antique copper (opt.422)



grafite (opz.421)
graphite (opt.421)



nichel (opz.420)
nickel (opt.420)









titanio ossidato
(opz.414)
titanium oxidized
(opt.414)

N.B.: ABBINAMENTO CONSIGLIATO
CON L'ANTA ACCIAIO EFFETTO OSSIDATO
NOTE: BEST MATCHING WITH THE
STEEL OXIDIZED EFFECT

GOLA "ELLE" ORIZZONTALE SOTTOTOP

UNDERMOUNT HORIZONTAL "ELLE" FINGER RAIL





| | COD. | | | COD. | | |
|---|---------|--|--|---|---------|--|
| <p>Gola sottotop tipo "A" Type "A" undermount finger rail</p>  <p style="text-align: right;">al ml per lm</p> | G950010 | | | <p>Angolo interno a 90° per gola tipo "A" 90° interior corner for "A" type finger rail</p>  <p style="text-align: right;">cadauno each</p> | G950050 | |
| <p>Terminale aperto dx o sx per gola tipo "A" da utilizzare a fine composizione RH or LH open end for type "A" finger rail to be placed at the end of the composition</p>  <p style="text-align: right;">terminale DX RH end terminale SX LH end</p> | G950021 | | | <p>Angolare con snodo per unione fuori squadra per gola tipo "A" Corner piece with joint for out-of-plumb joining for type "A" finger rail</p>  | | |
| <p>Terminale chiuso dx o sx per gola tipo "A" da utilizzare solo tra basi e colonne RH or LH closure for type "A" finger rail to be placed only between base units and column</p>  <p style="text-align: right;">terminale DX RH end terminale SX LH end</p> | G950031 | | | | | |
| <p>Coppia angolari per kit raccordo base angolo 110x110 Couple corner piece for fitting kit corner base unit 110x110</p>  <p style="text-align: center;">SX LH DX RH</p> <p style="text-align: right;">in alluminio aluminium angolare DX RH corner piece angolare SX LH corner piece</p> | G950058 | | | | | |
| | G950059 | | | | | |



GOLA "ELLE" ORIZZONTALE INTERMEDIA

INTERMEDIATE HORIZONTAL "ELLE" FINGER RAIL

GOLE "ELLE" VERTICALI PER COLONNE

VERTICAL "ELLE" FINGER RAILS FOR COLUMNS

| | COD. | |
|---|--------------------|--|
| <p>Gola intermedia tipo "B" Type "B" intermediate finger rail</p>  <p style="text-align: right;">al ml per lm</p> | G950110 | |
| <p>Terminale aperto dx o sx per gola tipo "B" da utilizzare a fine composizione RH or LH open end for type "B" finger rail to be placed at the end of the composition</p>  <p style="text-align: right;">terminale DX RH end terminale SX LH end</p> | G950121 G950122 | |
| <p>Terminale chiuso dx o sx per gola tipo "B" da utilizzare solo tra cassettiere e lavastoviglie/colonne RH or LH closure for type "B" finger rail to be placed only between drawer units and dishwasher/columns</p>  <p style="text-align: right;">terminale DX RH end terminale SX LH end</p> | G950131 G950132 | |
| <p>Angolo interno a 90° per gola tipo "B" 90° interior corner for "B" type finger rail</p>  <p style="text-align: right;">cadauno each</p> | G950150 | |

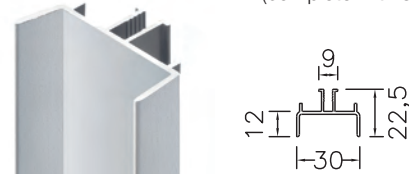
| | COD. | |
|--|--|--|
| <p>Mezza gola verticale tipo "C" (completa di distanziale) Type "C" half vertical finger rail (complete with spacer)</p>  <p style="text-align: right;">Piedi H 13 H 132 H 204 Piedi H 6 H 144 H 216</p> | G950330 G950350 G950340 G950360 | |
| <p>Gola verticale intermedia tipo "D" (completa di distanziale) Type "D" intermediate vertical finger rail (complete with spacer)</p>  <p style="text-align: right;">Piedi H 13 H 132 H 204 Piedi H 6 H 144 H 216</p> | G950430 G950450 G950440 G950460 | |
| <p>Gola verticale laterale tipo "E" (completa di distanziale) Type "E" lateral vertical finger rail (complete with spacer)</p>  <p style="text-align: right;">Piedi H 13 H 132 H 204 Piedi H 6 H 144 H 216</p> | G950530 G950550 G950540 G950560 | |

NOZIONI UTILI - gole "elle" orizzontali per basi

USEFUL INFORMATION - HORIZONTAL "ELLE" FINGER RAILS FOR BASE UNITS

VISTA FRONTALE ZOCCOLO H 13 PER BASI H 88

FRONT VIEW PLINTH H 13 FOR BASE UNITS H 88

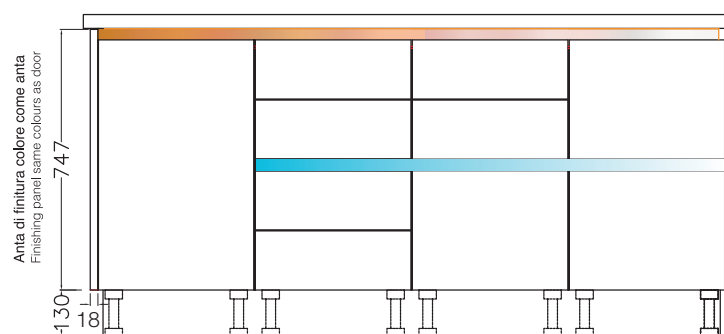
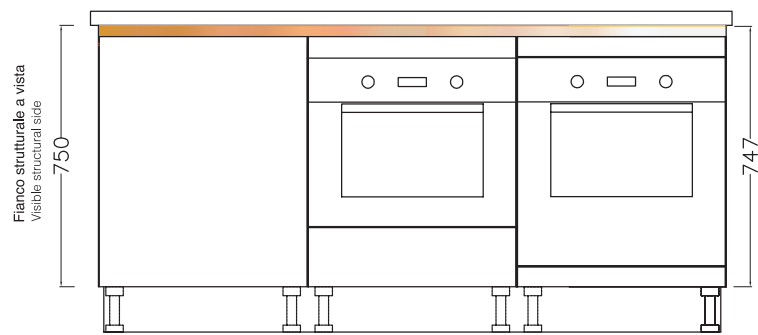

VISTA FRONTALE ZOCCOLO H 6 PER BASI H 90

FRONT VIEW PLINTH H 6 FOR BASE UNITS H 90

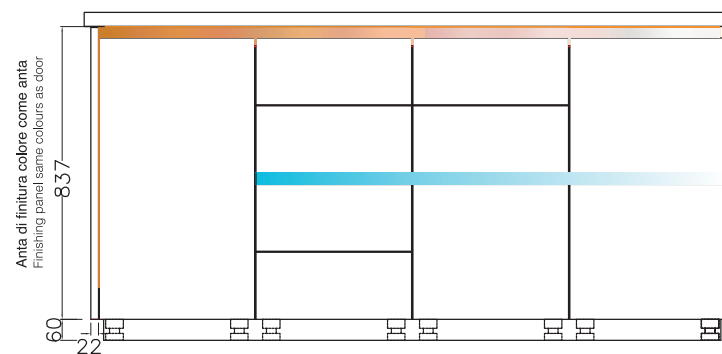
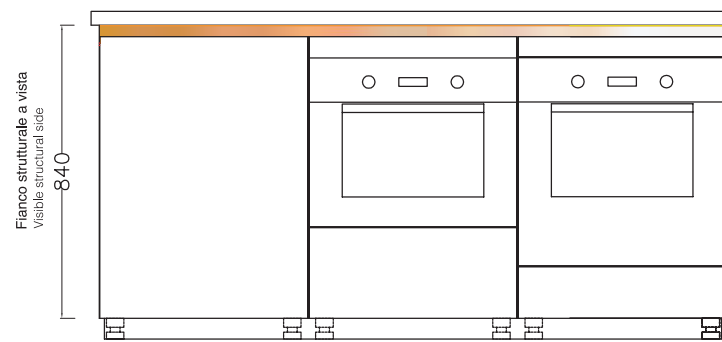

VISTA LATERALE (sezione) ZOCCOLO H 13 PER BASI H 88

SIDE VIEW (CROSS SECTION) PLINTH H 13 FOR BASE UNITS H 88

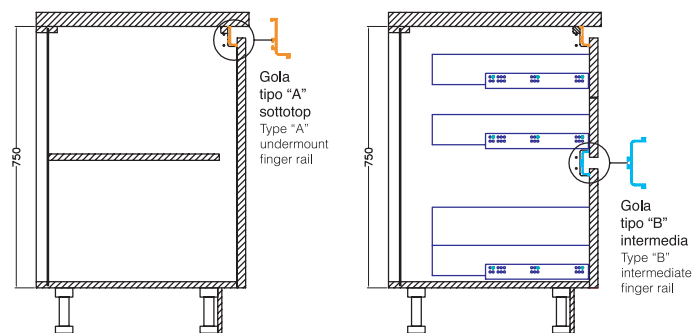

VISTA LATERALE (sezione) ZOCCOLO H 6 PER BASI H 90

SIDE VIEW (CROSS SECTION) PLINTH H 6 FOR BASE UNITS H 90

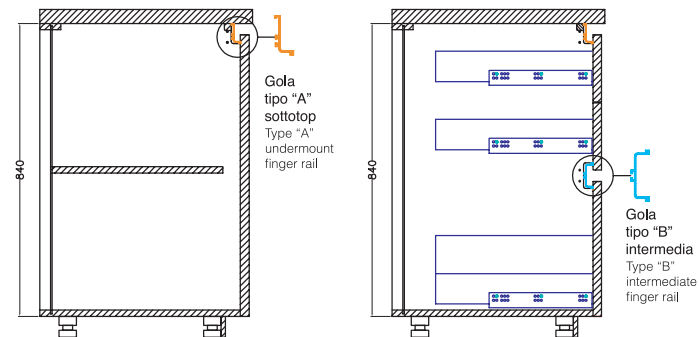

VISTA DALL'ALTO

TOP VIEW

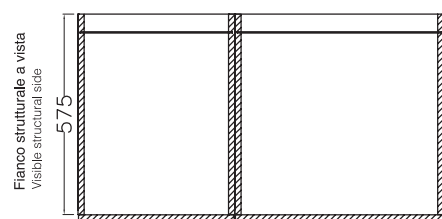

NOZIONI UTILI - gole "elle" verticali per colonne

USEFUL INFORMATION - VERTICAL "ELLE" FINGER RAILS FOR COLUMNS

VISTA FRONTALE ZOCCOLO H 13

FRONT VIEW PLINTH H 13

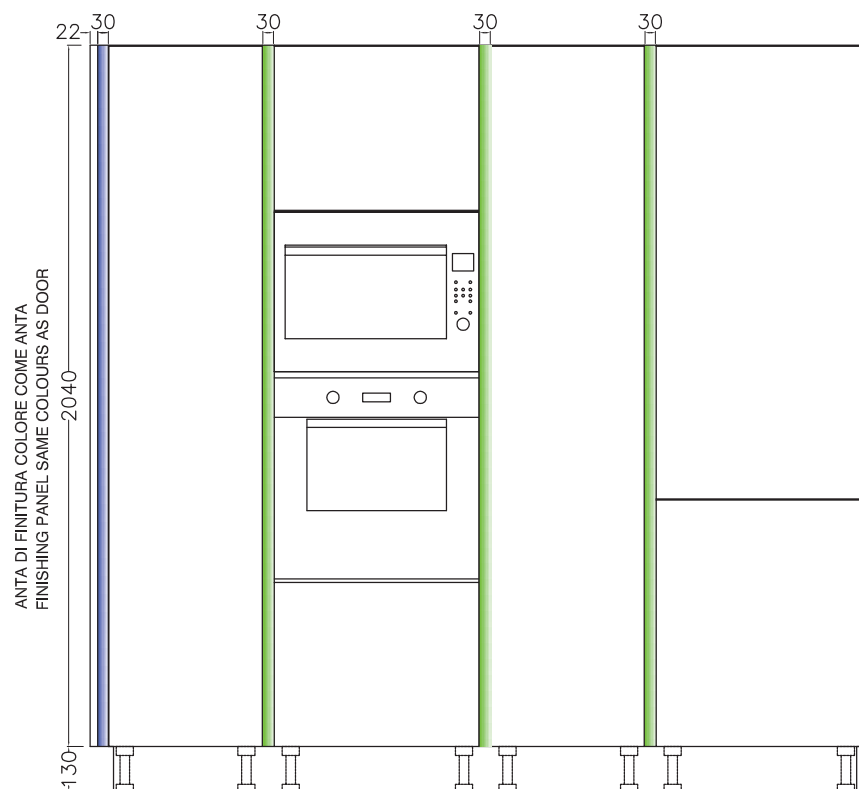

VISTA FRONTALE ZOCCOLO H 6

FRONT VIEW PLINTH H 6

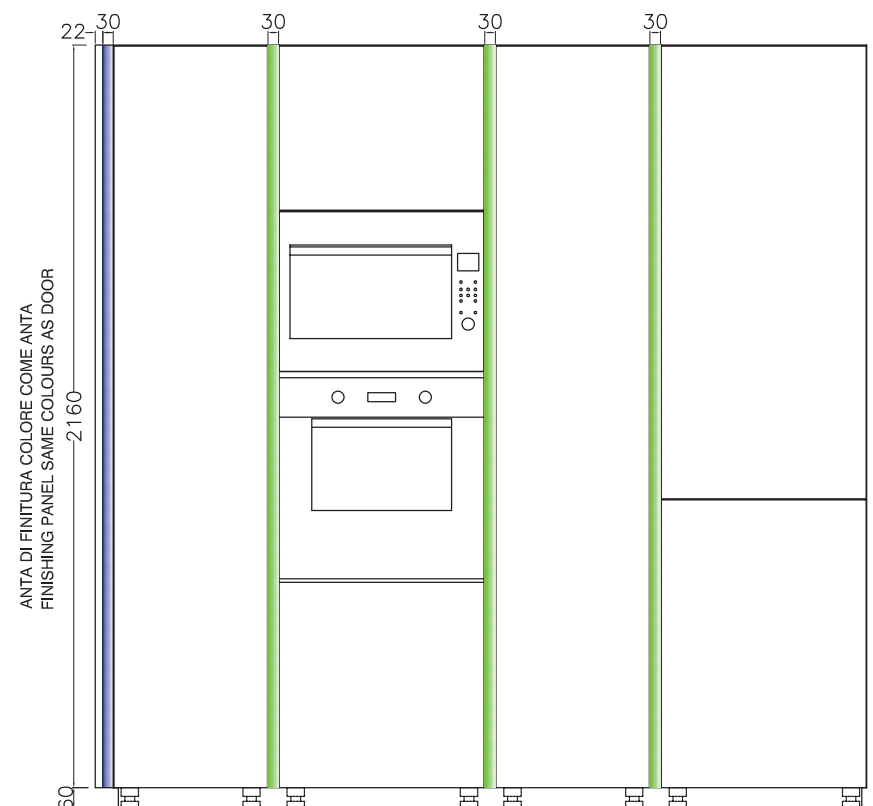

VISTA DALL'ALTO

TOP VIEW

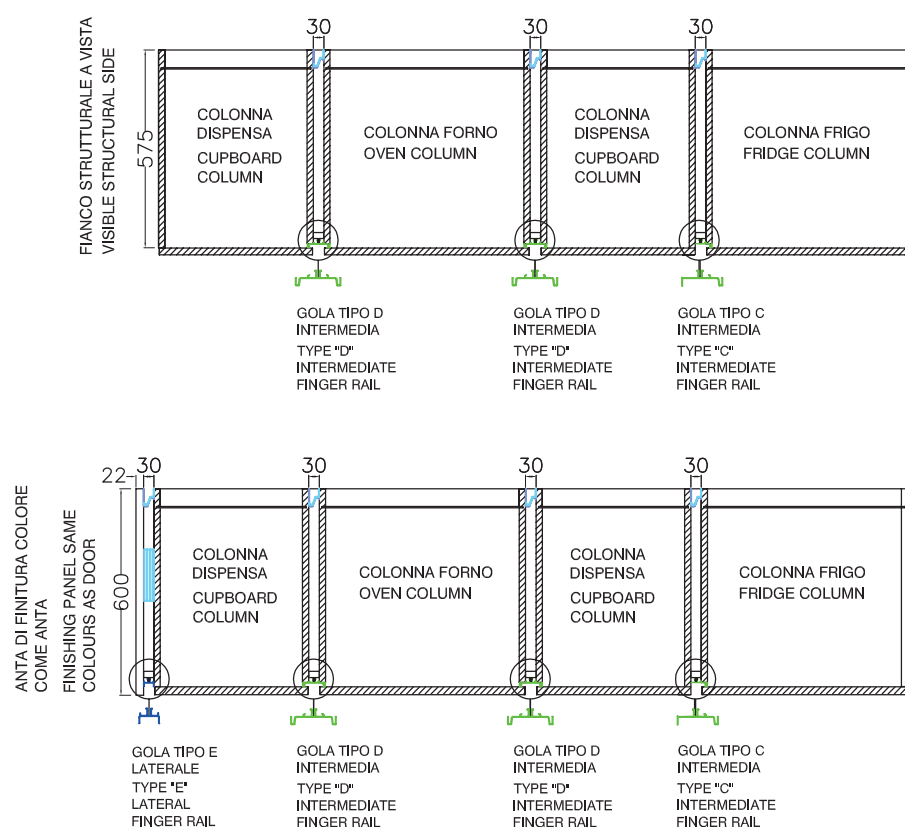

Composizione fianco strutturale
a vista come anta:
alla dimensione finale della cucina,
sommare sempre lo spessore dei
distanziali tra le colonne
(ogni distanziale 3 cm)

Composition with visible side panel to match door:
to the final size of the kitchen, always add the thickness
of the spacers between the two columns (each spacer 3 cm)

Composizione con ante di finitura
laterali, alla dimensione finale della
cucina, sommare sempre lo spessore
dei distanziali tra le colonne
(ogni distanziale 3 cm) e lo spessore
delle ante di finitura (ogni anta 2,2 cm)

Composition with side finishing panels to the final size of the
kitchen, always add the thickness of the spacer between the
two columns (each spacer 3 cm) and the thickness of the
finishing panels (each panel 2,2 mm)

CARATTERISTICHE TECNICHE

ANTE E FRONTALI CASSETTI

anta sp.22 mm impiallacciata **rovere spazzolata materica fiamma verticale con nodo**, bordo in massello di rovere 10/10 sui 4 lati, di cui 2 lati in larghezza vena trasversale e 2 lati in altezza vena longitudinale, con intarsio nei colori: rovere polvere filetto nero (opz.5402N), rovere grafite filetto nero (opz.5403N), rovere naturale filetto nero (opz.5404N), rovere tabacco filetto nero (opz.5405N)

anta sp.22 mm impiallacciata **rovere spazzolata materica fiamma verticale senza nodo**, bordo in massello di rovere 10/10 sui 4 lati, di cui 2 lati in larghezza vena trasversale e 2 lati in altezza vena longitudinale, con intarsio nei colori: rovere tan filetto nero (opz.5408N), rovere cenere filetto nero (opz.5409N)

anta sp.22 mm impiallacciata **poro semiaperto fiamma verticale senza nodo**, bordo in massello di rovere 10/10 sui 4 lati, di cui 2 lati in larghezza vena trasversale e 2 lati in altezza vena longitudinale con intarsio nei colori: rovere termocotto filetto rame (opz.5410R), rovere termocotto filetto ottone (opz.5410T), rovere termocotto filetto acciaio (opz.5410A), noce canaletto filetto rame (opz.1324R), noce canaletto filetto ottone (opz.1324T), noce canaletto filetto acciaio (opz.1324A), noce canaletto filetto nero (opz.1324N)

GOLE

vedi pag.8-9

STRUTTURE

ANTE: rovere naturale, rovere tan, noce canaletto

di serie : nobilitato visone (opz.948M) schiena e ripiano visone (opz.948M)

ANTE: rovere grafite, rovere polvere, rovere cenere

di serie : nobilitato lavagna (opz.9620) schiena e ripiano lavagna (opz.9620)

ANTE: rovere tabacco, rovere termocotto

di serie : nobilitato fango (opz.8860) schiena e ripiano fango (opz.8860)

a richiesta : nobilitato bianco (opz.001) schiena e ripiano bianco (opz.001)

nobilitato conchiglia (opz.8910) schiena e ripiano conchiglia (opz.8910)

nobilitato argilla (opz.9690) schiena e ripiano argilla (opz.9690)

MENSOLE

di serie: altezza cm 3,8 in laminato come strutture: bianco (opz.001), visone (opz.948M), lavagna (opz.9620), fango (opz.8860), argilla (opz.9690), conchiglia (opz.8910)

a richiesta: altezza cm 3,8 finiture come ante

ZOCCOLI

vedi pag.33



FOGLIO TRANCIATO CON FILETTO DI MM 1 IN LEGNO NERO O IN METALLO DI RAME, OTTONE, ACCIAIO

1° FASE

Selezione delle doghe di tranciato per tono colore, trama e venatura per armonizzare la composizione finale. Le doghe dovranno essere perfettamente "stese" per non compromettere la precisione nella fase di taglio successiva.

2° FASE

Taglio a misura delle doghe e del filetto in legno o in metallo.

Il taglio deve essere "netto" non sgranato e preciso nelle dimensioni perchè già in questa fase i vari elementi lavorati, determinano le dimensioni finali del foglio di tranciato.

3° FASE

La composizione del foglio si effettua accostando manualmente ogni singola dogha di tranciato ai filetti.

Le doghe sono scelte in base al tono di colore e la trama del tranciato, facendo molta attenzione alla direzione del "senso vena" della dogha stessa per evitare sgradevoli effetti visivi.

4° FASE

Giunzione manuale, una ad una in sequenza, delle doghe con i relativi filetti, per mezzo di carta impregnata di colla, fino alla composizione finale del "foglio di tranciato" sulla base delle dimensioni e dei "passi" del filetto indicati sul disegno tecnico.



TECHNICAL FEATURES

| | |
|-------------------------|--|
| DOORS AND DRAWER FRONTS | <p>22mm th. veneered brushed door in oak with knots and vertical grain textured finish, with 10/10 solid oak edge on the 4 sides, of which 2 upright sides with lengthwise grain and 2 horizontal sides with transverse grain, with inlaid detailing in the following colours: dust oak with black stripe (opt. 5402N), graphite oak with black stripe (opt. 5403N), natural oak with black stripe (opt. 5404N), tobacco oak with black stripe (opt. 5405N)</p> <p>22mm th. veneered brushed door in oak vertical grain textured finish without knots, with 10/10 solid oak edge on the 4 sides, of which 2 upright sides with lengthwise grain and 2 horizontal sides with transverse grain, with inlaid detailing in the following colours: tan oak with black stripe (opt. 5408N), ash oak with black stripe (opt. 5409N)</p> <p>22mm th. veneered semi-open pore vertical grain without knots, with 10/10 solid oak edging (lengthwise grain) on 4 sides, of which 2 upright sides with lengthwise grain and 2 horizontal sides with transverse grain, with inlaid detailing in the following colours: oak heat-treated copper rule (opt. 5410R), oak heat-treated brass rule (opt. 5410T), oak heat-treated steel rule (opt. 5410A), canaletto walnut with copper stripe (opt. 1324R), canaletto walnut with brass stripe (opt. 1324T), canaletto walnut with steel stripe (opt. 1324A), canaletto walnut with black stripe (opt. 1324N)</p> |
| FINGER RAILS | <p>see page 8-9</p> |
| STRUCTURES | <p>DOOR: natural oak, tan oak, canaletto walnut standard: melamine-coated mink (opt.948M), mink back panel and shelf (opt.948M) DOORS: graphite oak, dust oak, ash oak standard: melamine-coated slate grey (opt.9620), slate grey back panel and shelf (opt.9620) DOORS: tobacco oak, heat-treated oak standard: melamine-coated mud (opt.8860), mud back panel and shelf (opt.8860)</p> <p>on request: melamine-coated white (opt.001), white back panel and shelf (opt.001) melamine-coated shell (opt.8910) shell back panel and shelf (opt.8910) melamine-coated clay (opt.9690) clay back panel and shelf (opt.9690)</p> |
| SHELVES | <p>standard: height 3.8 cm, in laminate to match structure: white (opt.001), mink (opt.948M), slate grey (opt.9620), mud (opt.8860), clay (opt.9690), shell (opt.8910)</p> <p>on request: height 3.8 cm, with same finish as doors</p> |
| PLINTHS | <p>see page 33</p> |

SHEET OF VENEER WITH 1MM STRIPE IN BLACK WOOD OR COPPER, BRASS OR STEEL METAL

1st PHASE

Selection of colour, pattern and grain of the veneer slats to create the overall composition. The slats should be perfectly 'laid' so as not to compromise the precision of the subsequent cutting phase.

2nd PHASE

Cutting to measure of slats and stripe in wood or metal. The cut must be 'clean', sharp and with precise dimensions because at this stage the various different elements determine the final dimensions of the sheet of veneer.

3rd PHASE

The sheet is composed by manually placing each single veneer slat up against the stripes. The slats are chosen based on their colour and the pattern of the veneer, paying attention to the direction of the grain of each slat so as to avoid unpleasant visual effects.

4th PHASE

Manual joining of the slats and associated stripes, one by one in sequence, using paper impregnated with glue, until the final composition of the 'sheet of veneer' is achieved based on the dimensions and distances between stripes indicated on the technical drawing.

Impiallacciato-Veneered

Neck cod. N20

SP. 22 MM TH. 22 MM

ante rovere spazzolate materiche con nodo
brushed door in oak with knots textured finish



rovere polvere filetto nero
(opz.5402N)
fiamma verticale
dust oak with black stripe
(opt. 5402N)
vertical grain



rovere grafite filetto nero
(opz.5403N)
fiamma verticale
graphite oak with black stripe
(opt. 5403N)
vertical grain



rovere naturale filetto nero
(opz.5404N)
fiamma verticale
natural oak with black stripe
(opt. 5404N)
vertical grain



rovere tabacco filetto nero
(opz.5405N)
fiamma verticale
tobacco oak with black stripe
(opt. 5405N)
vertical grain

ante spazzolate materiche senza nodo
brushed door textured finish without knots



rovere tan filetto nero
(opz.5408N)
fiamma verticale
tan oak with black stripe
(opt. 5408N)
vertical grain



rovere cenere filetto nero
(opz.5409N)
fiamma verticale
ash oak with black stripe
(opt. 5409N)
vertical grain

Impiallacciato-Veneered

Neck cod. N20

SP. 22 MM TH. 22 MM

ante poro semiaperto senza nodo
semi-open pore door without knots



rovere termocotto filetto rame
(opz.5410R)
fiamma verticale
heat-treated oak with copper
stripe (opt. 5410R)
vertical grain



rovere termocotto filetto ottone
(opz.5410T)
fiamma verticale
heat-treated oak with brass
stripe (opt. 5410T)
vertical grain



rovere termocotto filetto acciaio
(opz.5410A)
fiamma verticale
heat-treated oak with steel stripe
(opt. 5410A)
vertical grain



noce canaletto filetto nero
(opz.1324N)
fiamma verticale
canaletto walnut with black stripe
(opt. 1324N)
vertical grain



noce canaletto filetto rame
(opz.1324R)
fiamma verticale
canaletto walnut with copper
stripe (opt. 1324R)
vertical grain



noce canaletto filetto ottone
(opz.1324T)
fiamma verticale
canaletto walnut with brass
stripe (opt. 1324T)
vertical grain



noce canaletto filetto acciaio
(opz.1324A)
fiamma verticale
canaletto walnut with steel stripe
(opt. 1324A)
vertical grain

Laccato metallo liquido ossidato

Lacquer tarnished liquid metal

SP. 22 MM

Neck cod. N21

CARATTERISTICHE TECNICHE

ANTE E FRONTALI CASSETTI

anta sp.22 mm in mdf certificato (conforme **CARB ATCM PHASE 2 ED EPA TSCA TITLE VI**) laccato metallo liquido ossidato nei colori: ottone ossidato (opz.MEOT), rame ossidato (opz.MERM)

N.B.: prodotto artigianale che nasce da una laminatura a freddo tramite l'applicazione di metallo liquido (ottone e rame) sul quale vengono fatti ossidare appositi reagenti, poi protetti con un applicativo specifico per metalli. I metalli sono elementi vivi ed il procedimento di corrosione chimica determina un effetto più o meno rilevante che non può essere considerato difetto.

GOLE

vedi pag.8-9

STRUTTURE

ANTE: ottone ossidato, rame ossidato

di serie : nobilitato fango (opz.8860) schiena e ripiano fango (opz.8860)

a richiesta : nobilitato bianco (opz.001) schiena e ripiano bianco (opz.001)
nobilitato lavagna (opz.9620) schiena e ripiano lavagna (opz.9620)
nobilitato conchiglia (opz.8910) schiena e ripiano conchiglia (opz.8910)
nobilitato argilla (opz.9690) schiena e ripiano argilla (opz.9690)
nobilitato visone (opz.948M) schiena e ripiano visone (opz.948M)



MENSOLE

di serie: altezza cm 3,8 in laminato come strutture: bianco (opz.001), visone (opz.948M), lavagna (opz.9620), fango (opz.8860), argilla (opz.9690), conchiglia (opz.8910)

a richiesta: altezza cm 3,8 finiture come ante

ZOCCOLI

vedi pag.33

TECHNICAL FEATURES

DOORS AND DRAWER FRONTS

22 mm-thick door in certified MDF (compliant with **CARB ATCM PHASE 2 ED EPA TSCA TITLE VI**) lacquered tarnished liquid metal in the following colours: tarnished brass (opt. MEOT), tarnished copper (opt. MERM)

N.B.: this is a hand-crafted product created using a cold lamination process during which liquid metal (brass and copper) is applied and tarnished using reactants. They are then protected by a dedicated finish for metals. Metals are natural elements and the chemical corrosion process creates a varied effect that should not be considered as a defect.

FINGER RAILS

see page 8-9

STRUCTURES

DOORS: tarnished brass, tarnished copper

standard: melamine-coated mud (opt.8860), mud back panel and shelf (opt.8860)

on request: melamine-coated white (opt.001), white back panel and shelf (opt.001)
melamine-coated slate grey (opt.9620), slate grey back panel and shelf (opt.9620)
melamine-coated shell (opt.8910) shell back panel and shelf (opt.8910)
melamine-coated clay (opt.9690) clay back panel and shelf (opt.9690)
melamine-coated mink (opt. 948M), mink back panel and shelf (opt.948M)

SHELVES

standard: height 3.8 cm, in laminate to match structure: white (opt.001), mink (opt.948M), slate grey (opt.9620), mud (opt.8860), clay (opt.9690), shell (opt.8910)

on request: height 3.8 cm, with same finish as doors

PLINTHS

see page 33



Laccato effetto metallo ossidato

Lacquered tarnished metal effect

SP. 22 MM

Neck cod. N21

CARATTERISTICHE TECNICHE

ANTE E FRONTALI CASSETTI

anta sp.22 mm in mdf certificato (conforme **CARB ATCM PHASE 2 ED EPA TSCA TITLE VI**) laccata semilucida effetto metallo ossidato nei colori: acciaio effetto ossidato (opz.LS01), acciaio nero effetto ossidato (opz.LS02)

N.B.: prodotto artigianale che nasce da un processo di laccatura alla quale segue una tamponatura manuale per replicare un effetto ossidato. Questa lavorazione determina un effetto più o meno rilevante che non può essere considerato difetto.

GOLE

vedi pag.8-9

STRUTTURE

ANTA: acciaio effetto ossidato

di serie : nobilitato argilla (opz.9690) schiena e ripiano argilla (opz.9690)

ANTA: acciaio nero effetto ossidato

di serie : nobilitato lavagna (opz.9620) schiena e ripiano lavagna (opz.9620)

a richiesta : nobilitato bianco (opz.001) schiena e ripiano bianco (opz.001)
nobilitato visone (opz.948M) schiena e ripiano visone (opz.948M)
nobilitato conchiglia (opz.8910) schiena e ripiano conchiglia (opz.8910)
nobilitato fango (opz.8860) schiena e ripiano fango (opz.8860)



MENSOLE

di serie: altezza cm 3,8 in laminato come strutture: bianco (opz.001), visone (opz.948M), lavagna (opz.9620), fango (opz.8860), argilla (opz.9690), conchiglia (opz.8910)

a richiesta: altezza cm 3,8 finiture come ante

ZOCCOLI

vedi pag.33

TECHNICAL FEATURES

DOORS AND DRAWER FRONTS

22 mm-thick door in certified MDF (compliant with **CARB ATCM PHASE 2 ED EPA TSCA TITLE VI**) in tarnished metal effect semi-gloss lacquer in the following colours: steel tarnished effect (opt. LS01), black steel tarnished effect (opt. LS02)

N.B.: this is a hand-crafted product created using a lacquering process followed by manual padding to simulate a tarnished effect. This process creates a varied effect that should not be considered as a defect.

FINGER RAILS

see page 8-9

STRUCTURES

DOOR: steel tarnished effect

standard: melamine-coated clay (opt.9690) clay back panel and shelf (opt.9690)

DOOR: black steel tarnished effect

standard: melamine-coated slate grey (opt.9620), slate grey back panel and shelf (opt.9620)

on request: melamine-coated white (opt.001), white back panel and shelf (opt.001)
melamine-coated mink (opt. 948M), mink back panel and shelf (opt.948M)
melamine-coated shell (opt.8910) shell back panel and shelf (opt.8910)
melamine-coated mud (opt.8860), mud back panel and shelf (opt.8860)

SHELVES

standard: height 3.8 cm, in laminate to match structure: white (opt.001), mink (opt.948M), slate grey (opt.9620), mud (opt.8860), clay (opt.9690), shell (opt.8910)

on request: height 3.8 cm, with same finish as doors

PLINTHS

see page 33



SP. 22 MM TH. 22 MM

Neck cod. **N21**

ante laccate metallo liquido ossidato
lacquered doors in tarnished liquid metal



ottone ossidato (opz.MEOT)
tarnished brass (opt. MEOT)



rame ossidato (opz.MERM)
tarnished copper (opt. MERM)

ante laccate effetto metallo ossidato
lacquered doors in tarnished metal effect



acciaio effetto ossidato
(opz.LS01)
steel tarnished effect (opt. LS01)

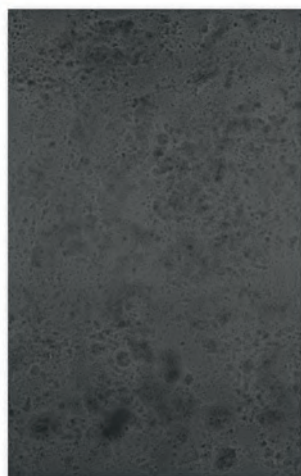

acciaio nero effetto ossidato
(opz.LS02)
black steel tarnished effect (opt. LS02)

Laccato effetto pelle

Lacquered leather effect

SP. 22 MM

Neck cod. N22

CARATTERISTICHE TECNICHE

ANTE E FRONTALI CASSETTI anta sp.22 mm in mdf certificato (conforme **CARB ATCM PHASE 2 ED EPA TSCA TITLE VI**) laccata opaca effetto pelle in rilievo nei colori: bianco (opz.LP01), terracotta (opz.LP04), fumo (opz.LP02), nero (opz.LP03)

GOLE [vedi pag.8-9](#)

STRUTTURE

ANTA: bianco
di serie : nobilitato bianco (opz.001) schiena e ripiano bianco (opz.001)

ANTA: terracotta
di serie : nobilitato fango (opz.8860) schiena e ripiano fango (opz.8860)

ANTA: fumo
di serie : nobilitato argilla (opz.9690) schiena e ripiano argilla (opz.9690)

ANTA: nero
di serie : nobilitato lavagna (opz.9620) schiena e ripiano lavagna (opz.9620)

a richiesta : nobilitato visone (opz.948M) schiena e ripiano visone (opz.948M)
nobilitato conchiglia (opz.8910) schiena e ripiano conchiglia (opz.8910)



MENSOLE

di serie: altezza cm 3,8 in laminato come strutture: bianco (opz.001), visone (opz.948M), lavagna (opz.9620), fango (opz.8860), argilla (opz.9690), conchiglia (opz.8910)

a richiesta: altezza cm 3,8 laccate lisce nei colori: bianco assoluto opaco (opz.740S), fumo opaco (opz.9531), nero opaco (opz.7892), terracotta opaco (opz.8895)

ZOCCOLI [vedi pag.33](#)

TECHNICAL FEATURES

DOORS AND DRAWER FRONTS 22 mm-thick door in certified MDF (compliant with **CARB ATCM PHASE 2 ED EPA TSCA TITLE VI**) lacquered in relief leather effect matt in the following colours: white (opt. LP01), terracotta (opt. LP04), smoke (opt. LP02), black (opt. LP03)

FINGER RAILS [see page 8-9](#)

STRUCTURES

DOOR: white
standard: melamine-coated white (opt.001), white back panel and shelf (opt.001)

DOOR: terracotta
standard: melamine-coated mud (opt.8860), mud back panel and shelf (opt.8860)

DOOR: smoke
standard: melamine-coated clay (opt.9690) clay back panel and shelf (opt.9690)

DOOR: black
standard: melamine-coated slate grey (opt.9620), slate grey back panel and shelf (opt.9620)

on request: melamine-coated mink (opt. 948M), mink back panel and shelf (opt.948M)
melamine-coated shell (opt.8910) shell back panel and shelf (opt.8910)

SHELVES

standard: height 3.8 cm, in laminate to match structure: white (opt.001), mink (opt.948M), slate grey (opt.9620), mud (opt.8860), clay (opt.9690), shell (opt.8910)

on request: height 3.8 cm, smooth lacquered in the colours: matt absolute white (opt.740S), matt smoke (opt.9531), matt black (opt.7892), matt terracotta (opt.8895)

PLINTHS [see page 33](#)



Laccato effetto pelle Lacquered leather effect

Neck cod. **N22**

SP. 22 MM TH. 22 MM

ante laccate effetto pelle
lacquered doors in leather effect



bianco (opz.LP01)
white (opt.LP01)

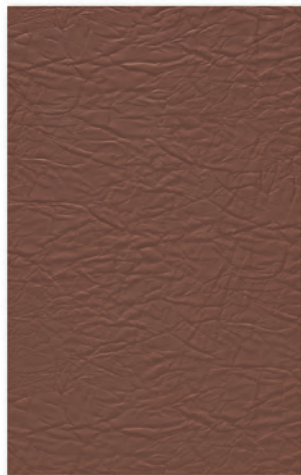

terracotta (opz.LP04)
terracotta (opt.LP04)



fumo (opz.LP02)
smoke (opt.LP02)



nero (opz.LP03)
black (opt.LP03)



Bridge

ANTA QUADRATA CON MANIGLIA

SQUARE DOOR WITH HANDLE OPENING



FRONTALE

anta con maniglia frontale
door with front handle

UNA MANIGLIA PER UNA CUCINA DI QUALITÀ ESPRESSIONE DI FUNZIONALITÀ E DESIGN.

SOTTILI, A BASE RETTANGOLARE, DIVENTANO ELEGANTI SEGNI GRAFICI, DISTINTIVI, SENZA ALTERARE I VOLUMI DI UN PROGETTO RIGOROSAMENTE ESSENZIALE COME QUELLO DEL DESIGN COLLECTION.

A HANDLE FOR A QUALITY KITCHEN, EXPRESSION OF FUNCTIONALITY AND DESIGN.

THIN AND WITH A RECTANGULAR BASE, THEY BECOME ELEGANT GRAPHIC AND DISTINCTIVE SIGNS, WITHOUT CHANGING THE VOLUMES OF A RIGOROUSLY ESSENTIAL PROJECT SUCH AS THAT OF THE DESIGN COLLECTION.





Laccato metallo liquido ossidato

Lacquer tarnished liquid metal

SP. 22 MM

Bridge cod. **B21**

CARATTERISTICHE TECNICHE

ANTE E FRONTALI CASSETTI

anta sp.22 mm in mdf certificato (conforme **CARB ATCM PHASE 2 ED EPA TSCA TITLE VI**) laccato metallo liquido ossidato nei colori: ottone ossidato (opz.MEOT), rame ossidato (opz.MERM)

N.B.: prodotto artigianale che nasce da una laminatura a freddo tramite l'applicazione di metallo liquido (ottone e rame) sul quale vengono fatti ossidare appositi reagenti, poi protetti con un applicativo specifico per metalli. I metalli sono elementi vivi ed il procedimento di corrosione chimica determina un effetto più o meno rilevante che non può essere considerato difetto.

MANIGLIE

vedi pag.30-31

STRUTTURE

ANTE: ottone ossidato, rame ossidato

di serie : nobilitato fango (opz.8860) schiena e ripiano fango (opz.8860)

a richiesta : nobilitato bianco (opz.001) schiena e ripiano bianco (opz.001)
nobilitato lavagna (opz.9620) schiena e ripiano lavagna (opz.9620)
nobilitato conchiglia (opz.8910) schiena e ripiano conchiglia (opz.8910)
nobilitato argilla (opz.9690) schiena e ripiano argilla (opz.9690)
nobilitato visone (opz.948M) schiena e ripiano visone (opz.948M)



MENSOLE

di serie: altezza cm 3,8 in laminato come strutture: bianco (opz.001), visone (opz.948M), lavagna (opz.9620), fango (opz.8860), argilla (opz.9690), conchiglia (opz.8910)

a richiesta: altezza cm 3,8 finiture come ante

ZOCCOLI

vedi pag.33

TECHNICAL FEATURES

DOORS AND DRAWER FRONTS

22 mm-thick door in certified MDF (compliant with **CARB ATCM PHASE 2 ED EPA TSCA TITLE VI**) lacquered tarnished liquid metal in the following colours: tarnished brass (opt. MEOT), tarnished copper (opt. MERM)

N.B.: this is a hand-crafted product created using a cold lamination process during which liquid metal (brass and copper) is applied and tarnished using reactants. They are then protected by a dedicated finish for metals. Metals are natural elements and the chemical corrosion process creates a varied effect that should not be considered as a defect.

HANDLES

see page 30-31

STRUCTURES

DOORS: tarnished brass, tarnished copper

standard: melamine-coated mud (opt.8860), mud back panel and shelf (opt.8860)

on request: melamine-coated white (opt.001), white back panel and shelf (opt.001)
melamine-coated slate grey (opt.9620), slate grey back panel and shelf (opt.9620)
melamine-coated shell (opt.8910) shell back panel and shelf (opt.8910)
melamine-coated clay (opt.9690) clay back panel and shelf (opt.9690)
melamine-coated mink (opt. 948M), mink back panel and shelf (opt.948M)

SHELVES

standard: height 3.8 cm, in laminate to match structure: white (opt.001), mink (opt.948M), slate grey (opt.9620), mud (opt.8860), clay (opt.9690), shell (opt.8910)

on request: height 3.8 cm, with same finish as doors

PLINTHS

see page 33



Laccato effetto metallo ossidato

Lacquered tarnished metal effect

SP. 22 MM

Bridge cod. **B21**

CARATTERISTICHE TECNICHE

ANTE E FRONTALI CASSETTI

anta sp.22 mm in mdf certificato (conforme **CARB ATCM PHASE 2 ED EPA TSCA TITLE VI**) laccata semilucida effetto metallo ossidato nei colori: acciaio effetto ossidato (opz.LS01), acciaio nero effetto ossidato (opz.LS02)

N.B.: prodotto artigianale che nasce da un processo di laccatura alla quale segue una tamponatura manuale per replicare un effetto ossidato. Questa lavorazione determina un effetto più o meno rilevante che non può essere considerato difetto.

MANIGLIE

vedi pag.30-31

STRUTTURE

ANTA: acciaio effetto ossidato

di serie : nobilitato argilla (opz.9690) schiena e ripiano argilla (opz.9690)

ANTA: acciaio nero effetto ossidato

di serie : nobilitato lavagna (opz.9620) schiena e ripiano lavagna (opz.9620)

a richiesta : nobilitato bianco (opz.001) schiena e ripiano bianco (opz.001)
nobilitato visone (opz.948M) schiena e ripiano visone (opz.948M)
nobilitato conchiglia (opz.8910) schiena e ripiano conchiglia (opz.8910)
nobilitato fango (opz.8860) schiena e ripiano fango (opz.8860)



MENSOLE

di serie: altezza cm 3,8 in laminato come strutture: bianco (opz.001), visone (opz.948M), lavagna (opz.9620), fango (opz.8860), argilla (opz.9690), conchiglia (opz.8910)

a richiesta: altezza cm 3,8 finiture come ante

ZOCCOLI

vedi pag.33

TECHNICAL FEATURES

DOORS AND DRAWER FRONTS

22 mm-thick door in certified MDF (compliant with **CARB ATCM PHASE 2 ED EPA TSCA TITLE VI**) in tarnished metal effect semi-gloss lacquer in the following colours: steel tarnished effect (opt. LS01), black steel tarnished effect (opt. LS02)

N.B.: this is a hand-crafted product created using a lacquering process followed by manual padding to simulate a tarnished effect. This process creates a varied effect that should not be considered as a defect.

HANDLES

see page 30-31

STRUCTURES

DOOR: steel tarnished effect

standard: melamine-coated clay (opt.9690) clay back panel and shelf (opt.9690)

DOOR: black steel tarnished effect

standard: melamine-coated slate grey (opt.9620), slate grey back panel and shelf (opt.9620)

on request: melamine-coated white (opt.001), white back panel and shelf (opt.001)
melamine-coated mink (opt. 948M), mink back panel and shelf (opt.948M)
melamine-coated shell (opt.8910) shell back panel and shelf (opt.8910)
melamine-coated mud (opt.8860), mud back panel and shelf (opt.8860)

SHELVES

standard: height 3.8 cm, in laminate to match structure: white (opt.001), mink (opt.948M), slate grey (opt.9620), mud (opt.8860), clay (opt.9690), shell (opt.8910)

on request: height 3.8 cm, with same finish as doors

PLINTHS

see page 33



SP. 22 MM TH. 22 MM

ante laccate metallo liquido ossidato
lacquered doors in tarnished liquid metal



ottone ossidato (opz.MEOT)
tarnished brass (opt. MEOT)



rame ossidato (opz.MERM)
tarnished copper (opt. MERM)

ante laccate effetto metallo ossidato
lacquered doors in tarnished metal effect

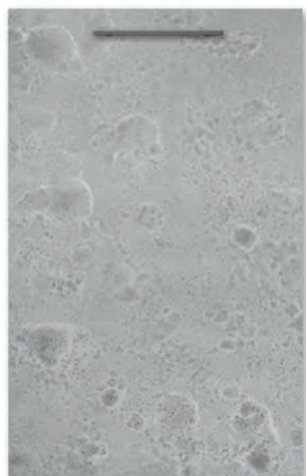

acciaio effetto ossidato
(opz.LS01)
steel tarnished effect (opt. LS01)

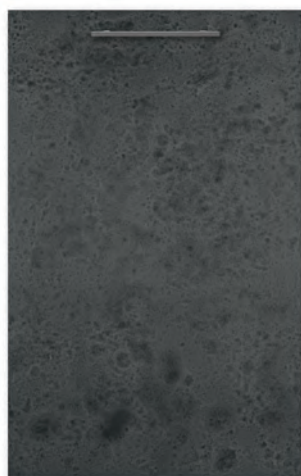

acciaio nero effetto ossidato
(opz.LS02)
black steel tarnished effect (opt. LS02)

MANIGLIE HANDLES

DC020 **B**ridge

DI SERIE STANDARD



Maniglia 57RA finitura rame anticato
 anta L 15 → passo 12 mm
 anta L 30 a L 45 → passo 160 mm
 anta da L 60 a L 120 → passo 320 mm

Handle 57RA antique copper finish
 door W 15 → centre-to-centre distance 12 mm
 door W 30 to W 45 → centre-to-centre distance 160 mm
 door from W 60 to W 120 → centre-to-centre distance 320 mm



Maniglia 57BA finitura bronzo anticato
 anta L 15 → passo 12 mm
 anta L 30 a L 45 → passo 160 mm
 anta da L 60 a L 120 → passo 320 mm

Handle 57BA antique bronze finish
 door W 15 → centre-to-centre distance 12 mm
 door W 30 to W 45 → centre-to-centre distance 160 mm
 door from W 60 to W 120 → centre-to-centre distance 320 mm



Maniglia 57BB finitura bronzo brunito
 anta L 15 → passo 12 mm
 anta L 30 a L 45 → passo 160 mm
 anta da L 60 a L 120 → passo 320 mm

Handle 57BB burnished bronze finish
 door W 15 → centre-to-centre distance 12 mm
 door W 30 to W 45 → centre-to-centre distance 160 mm
 door from W 60 to W 120 → centre-to-centre distance 320 mm



Maniglia 57F finitura grafite
 anta L 15 → passo 12 mm
 anta L 30 a L 45 → passo 160 mm
 anta da L 60 a L 120 → passo 320 mm

Handle 57F graphite finish
 door W 15 → centre-to-centre distance 12 mm
 door W 30 to W 45 → centre-to-centre distance 160 mm
 door from W 60 to W 120 → centre-to-centre distance 320 mm



Maniglia 57K finitura nichel
 anta L 15 → passo 12 mm
 anta L 30 a L 45 → passo 160 mm
 anta da L 60 a L 120 → passo 320 mm

Handle 57K nickel finish
 door W 15 → centre-to-centre distance 12 mm
 door W 30 to W 45 → centre-to-centre distance 160 mm
 door from W 60 to W 120 → centre-to-centre distance 320 mm

A RICHIESTA ON REQUEST



Maniglia 59RA finitura anodizzato rame anticato
 anta L 15 → passo 32 mm
 anta L 30 a L 45 → passo 160 mm
 anta da L 60 a L 120 → passo 448 mm

Handle 59RA oxidized antique copper finish
 door W 15 → centre-to-centre distance 32 mm
 door W 30 to W 45 → centre-to-centre distance 160 mm
 door from W 60 to W 120 → centre-to-centre distance 448 mm



Maniglia 59BA finitura anodizzato bronzo anticato
 anta L 15 → passo 32 mm
 anta L 30 a L 45 → passo 160 mm
 anta da L 60 a L 120 → passo 448 mm

Handle 59BA oxidized antique bronze finish
 door W 15 → centre-to-centre distance 32 mm
 door W 30 to W 45 → centre-to-centre distance 160 mm
 door from W 60 to W 120 → centre-to-centre distance 448 mm



Maniglia 59BB finitura anodizzato titanio
 anta L 15 → passo 32 mm
 anta L 30 a L 45 → passo 160 mm
 anta da L 60 a L 120 → passo 448 mm

Handle 59BB oxidized titanium finish
 door W 15 → centre-to-centre distance 32 mm
 door W 30 to W 45 → centre-to-centre distance 160 mm
 door from W 60 to W 120 → centre-to-centre distance 448 mm



Maniglia 59F finitura anodizzato grafite
 anta L 15 → passo 32 mm
 anta L 30 a L 45 → passo 160 mm
 anta da L 60 a L 120 → passo 448 mm

Handle 59F oxidized graphite finish
 door W 15 → centre-to-centre distance 32 mm
 door W 30 to W 45 → centre-to-centre distance 160 mm
 door from W 60 to W 120 → centre-to-centre distance 448 mm



Maniglia 59K finitura anodizzato acciaio
 anta L 15 → passo 32 mm
 anta L 30 a L 45 → passo 160 mm
 anta da L 60 a L 120 → passo 448 mm

Handle 59K oxidized stainless steel finish
 door W 15 → centre-to-centre distance 32 mm
 door W 30 to W 45 → centre-to-centre distance 160 mm
 door from W 60 to W 120 → centre-to-centre distance 448 mm



Maniglia 59N finitura anodizzato nero
 anta L 15 → passo 32 mm
 anta L 30 a L 45 → passo 160 mm
 anta da L 60 a L 120 → passo 448 mm

Handle 59N oxidized black finish
 door W 15 → centre-to-centre distance 32 mm
 door W 30 to W 45 → centre-to-centre distance 160 mm
 door from W 60 to W 120 → centre-to-centre distance 448 mm

MANIGLIA ORIZZONTALE HANDLE HORIZONTAL

DC020 **B**ridge



Maniglia M40 finitura nero soft
 passo in funzione dell'anta
 Handle M40 soft black finish
 centre-to-centre distance varies according to the door

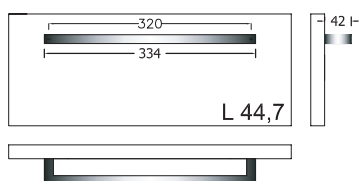
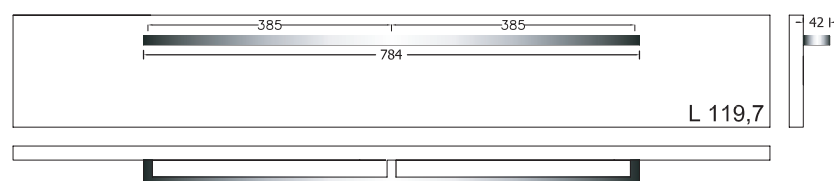
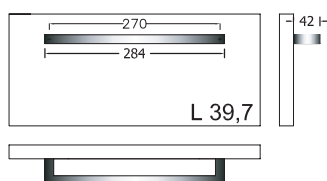
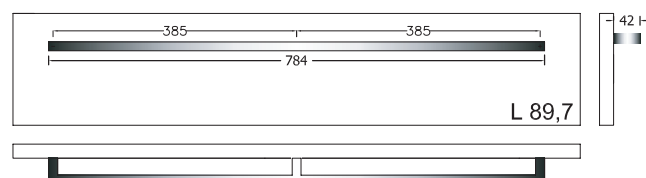
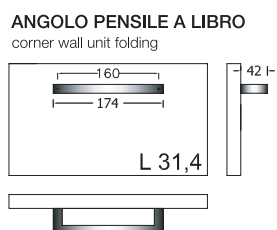
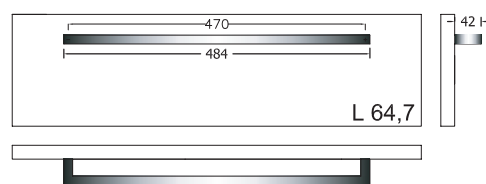
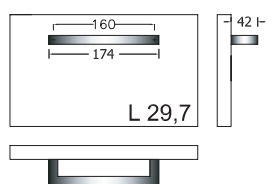
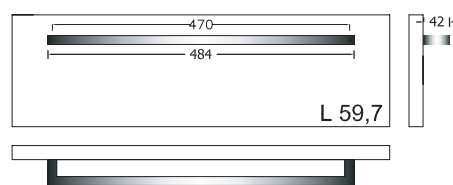
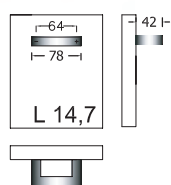

strutture carcasses



bianco (opz.001)
schiena e ripiano bianco
(opz.001)
white (opt.001)
white back panel
and shelf (opt.001)



visone (opz.948M)
schiena e ripiano visone
(opz.948M)
mink (opt.948M)
mink back panel
and shelf (opt.948M)



lavagna (opz.9620)
schiena e ripiano lavagna
(opz.9620)
slate grey (opt.9620)
slate grey back panel
and shelf (opt.9620)



fango (opz.8860)
schiena e ripiano fango
(opz.8860)
mud (opt.8860)
mud back panel
and shelf (opt.8860)



conchiglia (opz.8910)
schiena e ripiano
conchiglia (opz.8910)
shell (opt.8910)
shell back panel
and shelf (opt.8910)



argilla (opz.9690)
schiena e ripiano argilla
(opz.9690)
clay (opt.9690)
clay back panel
and shelf (opt.9690)



LUBE ECOLOGIC

IL GRUPPO LUBE HA SCELTO DI UTILIZZARE PER I COMPONENTI COSTITUENTI LE STRUTTURE DELLE CUCINE SOLO MATERIALE A BASSISSIMA EMISSIONE DI FORMALDEIDE: CONFORMI ALLO STANDARD F★★★★ SECONDO LA NORMA JIS, CERTIFICATO DAL MINISTERO GIAPPONESE, IL PIU' SEVERO IN MERITO ALLE NORMATIVE DI SALVAGUARDIA AMBIENTALE.

LUBE GROUP HAS CHOSEN TO EXCLUSIVELY USE MATERIALS WITH VERY LOW FORMALDEHYDE EMISSIONS FOR THE COMPONENTS MAKING UP THE KITCHEN CARCASSES: THESE ELEMENTS COMPLY WITH THE F4 STAR STANDARD ACCORDING TO JIS, CERTIFIED BY THE JAPANESE GOVERNMENT - THE MOST STRINGENT WHEN IT COMES TO ENVIRONMENTAL PROTECTION.

mensole in laminato P 31-61 come strutture same colours as carcasses laminated shelves D 31-61



bianco (opz.001)
white (opt.001)



conchiglia (opz.8910)
shell (opt.8910)

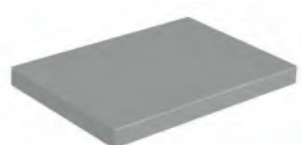

argilla (opz.9690)
clay (opt.9690)

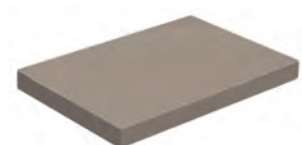

visone (opz.948M)
mink (opt.948M)

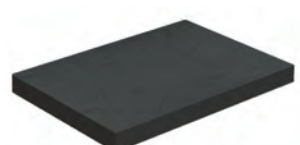

lavagna (opz.9620)
slate grey (opt.9620)

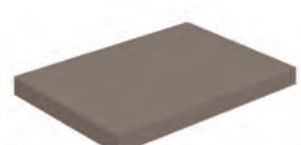

fango (opz.8860)
mud (opt.8860)

mensole laccate n.b.: da abbinare alle finiture laccate effetto pelle lacquered shelves note: to be combined with leather-effect lacquered finishes



bianco assoluto opaco
(opz.740S)
matt absolute white
(opt.740S)

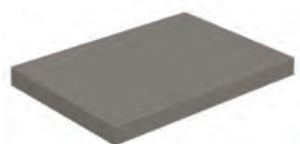

fumo opaco (opz.9531)
matt smoke (opt.9531)



nero opaco (opz.7892)
matt black (opt.7892)



terracotta opaco (opz.8895)
matt terracotta (opt.8895)

mensole impialacciate veneered shelves



impiallacciata colore anta senza filetto
N.B.: per le finiture vedi pagine 16-17
veneered without stripe same
finish as door
Note: for the finishes see pages 16-17

mensole metallo liquido ossidato shelves in tarnished liquid metal



metallo liquido ossidato come anta
N.B.: per le finiture vedi pagine 21
tarnished liquid metal to match doors
Note: for the finishes see page 21

mensole laccate effetto metallo ossidato lacquered shelves in tarnished metal effect

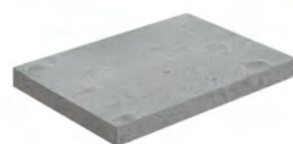

laccate effetto metallo ossidato
come anta
N.B.: per le finiture vedi pagina 21
lacquered tarnished metal effect
to match doors
Note: for the finishes see page 21

mensole laccate effetto marmo lacquered shelves in marble effect



laccate effetto marmo come anta
N.B.: per le finiture vedi pagine 21
lacquered marble effect to match doors
Note: for the finishes see page 21

zoccoli in alluminio H 13 aluminium plinth H 13

di serie
standard

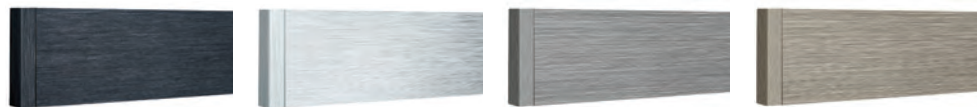

alluminio finitura urban
ossidato (opz.NU)
aluminium urban
oxidized finish (opt.NU)

alluminio
finitura brill (opz.412)
aluminium
brill finish (opt.412)

alluminio finitura
grafite (opz.421)
aluminium graphite
finish (opt.421)

alluminio finitura nichel
(opz.420)
aluminium nickel
finish (opt.420)

zoccoli in alluminio H 13 verniciati a polvere finitura opaca aluminum plinth height H 13 powder coated matt finish



alluminio finitura nero
(opz.7892)
aluminium
black finish (opt.7892)

alluminio finitura fumo
(opz.9531)
aluminium
smoke finish
(opt.9531)

alluminio finitura
bianco caldo (opz.7401)
aluminium warm white
finish (opt.7401)

alluminio finitura
bianco assoluto (opz.740S)
aluminium absolute
white finish (opt.740S)



alluminio finitura grigio
bromo (opz.9533)
aluminium bromine
grey finish (opt.9533)

alluminio finitura
silver dark (opz.9507)
aluminium dark silver
finish (opt.9507)

alluminio finitura
castoro (opz.8907)
aluminium beaver
finish (opt.8907)

alluminio finitura
cenere (opz.9547)
aluminium ash
finish (opt.9547)



alluminio finitura
conchiglia (opz.7403)
aluminium shell
finish (opt.7403)

alluminio finitura
ghisa (opz.9509)
aluminium cast iron
finish (opt.9509)

alluminio finitura
argilla (opz.9503)
aluminium clay
finish (opt.9503)

alluminio finitura
grigio selce (opz.SE)
aluminium flint grey
finish (opt.SE)



alluminio finitura
bistro (opz.9535)
aluminium bistro
finish (opt.9535)

alluminio finitura
ossido ottone
(opz.MEOT)
aluminium with
tarnished brass finish
(opt. MEOT)

alluminio finitura
ossido rame
(opz.MERM)
aluminium with
tarnished copper finish
(opt. MERM)

MODULARITÀ E COMPONIBILITÀ MODULARITY AND FITTING SOLUTIONS

- ESCLUSO 45 * SOLO 90
- ESCLUSO 45 ONLY 90
- ESCLUSO 120 ** SOLO 45
- ESCLUSO 120 ONLY 45

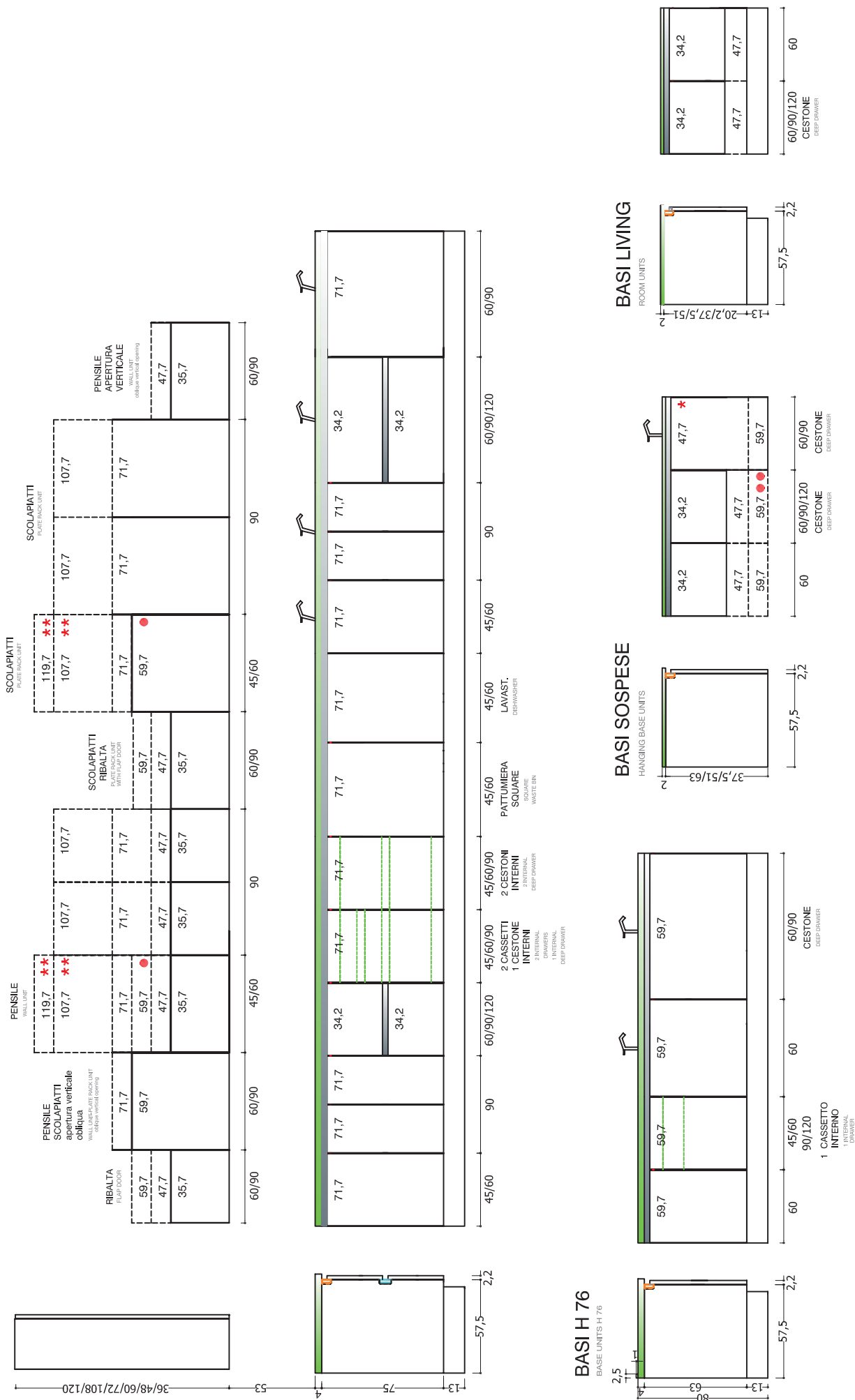

MODULARITÀ E COMPONIBILITÀ MODULARITY AND FITTING SOLUTIONS

COLONNE FRIGO

FRIDGE COLUMNS

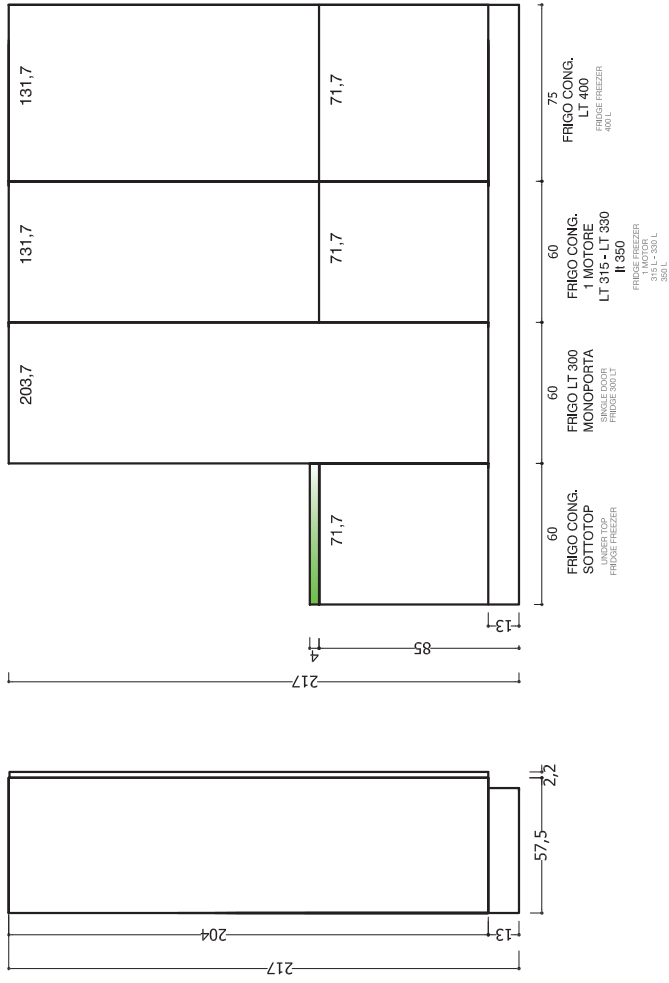

COLONNE FORNO

OVEN COLUMNS

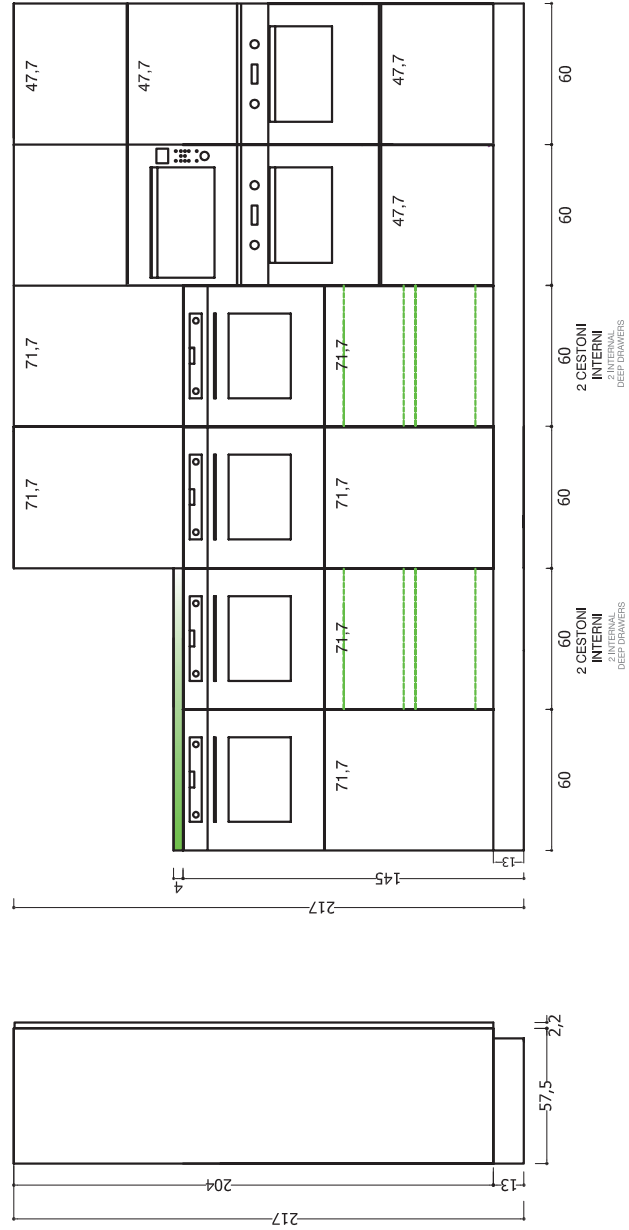

APERTURA A RIBALTA

Le ante aprendosi verso l'alto consentono di avere un' ampia visione d'insieme all'interno del mobile.

La regolazione della forza di apertura può essere impostata in modo esatto in base al peso del frontale. Grazie all'arresto progressivo le ante si fermano in qualsiasi posizione; in questo modo la maniglia è sempre facilmente raggiungibile. La chiusura è ammortizzata e un'unica manovra è sufficiente per regolare il frontale tridimensionalmente grazie all'assenza di cerniere e al sistema di aggancio clip.

WALL UNIT WITH FLAP DOOR

The doors that open upwards guarantee ample overall visibility inside the cabinet.

The opening force can be adjusted precisely according to the weight of the front. The doors stop in any position thanks to the gradual stopping movement; in this way, the handle is always easily accessible. The closing movement is cushioned and a single manoeuvre is required to three-dimensionally adjust the front, thanks to the clip-on system and the absence of hinges.



DI SERIE
STANDARD



MOTORIZZATO
SERVO-DRIVE
SERVO-DRIVE
MOTORISED
(Opz.007)

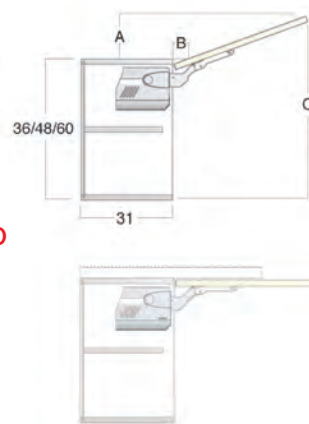

| | A | B | C |
|------|------|-----|----|
| H 36 | 11,5 | 3,5 | 37 |
| H 48 | 15 | 3,5 | 49 |
| H 60 | 18,5 | 3,5 | 61 |

Per evitare l'interferenza dell'anta in fase di apertura con cornici o mensole, si può richiedere il limitatore dell'angolo di apertura cod. 5620010

In order to avoid that the door interferes with cornices or shelves during the opening movement, it is possible to request an opening angle limiter: code 5620010

SCHEMA MONTAGGIO LIMITATORE PER RIBALTA H 36
FLAP DOOR LIMITER INSTALLATION DIAGRAM H 36

SCHEMA MONTAGGIO LIMITATORE PER RIBALTA H 48
FLAP DOOR LIMITER INSTALLATION DIAGRAM H 48

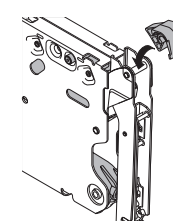
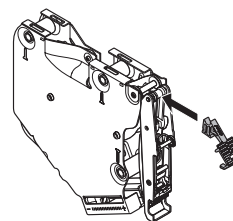

APERTURA VERTICALE OBLIQUA

I pensili con questo tipo di meccanismo necessitano per l'apertura di poco spazio libero sopra il mobile grazie al movimento basculante dell'anta che si apre senza difficoltà applicando poca forza anche in presenza di frontali pesanti. Con l'arresto progressivo le ante si fermano in qualsiasi posizione; in questo modo la maniglia è sempre facilmente raggiungibile. La chiusura è ammortizzata ed è possibile regolare la forza di tenuta in base al peso del frontale.

VERTICAL OPENING OBLIQUE

Wall units that mount this type of mechanism require little clearance above the cabinet thanks to the swivelling movement of the door that can be easily opened by applying slight pressure, even with heavy fronts. The doors stop in any position thanks to the gradual stopping movement; in this way, the handle is always easily accessible. The closing movement is cushioned and the closing force can be adjusted according to the weight of the front door.



DI SERIE
STANDARD



MOTORIZZATO
SERVO-DRIVE
SERVO-DRIVE
MOTORISED
(Opz.007)

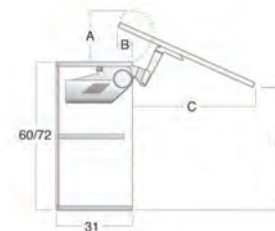

| | A | B | C | D |
|------|----|-----|------|------|
| H 60 | 18 | 9,6 | 46,5 | 53,5 |
| H 72 | 18 | 9,6 | 57 | 61 |

APERTURA VERTICALE

L'anta ad apertura verticale, potendo essere sollevata completamente verso l'alto, consente un accesso totale all'interno del pensile. Ideale per l'impiego in mobili a colonna per nascondere ad esempio apparecchi elettrici, o pensili con corpi mobili sovrastanti, ha la chiusura ammortizzata e la possibilità di regolare la forza di tenuta in base al peso del frontale.

VERTICAL OPENING

Doors with vertical opening movement can be fully raised to fully access the inside of the wall unit.

Ideal for use on column units to conceal electrical appliances for examples, or on wall units surmounted by mobile units.

The closing movement is cushioned and the closing force can be adjusted according to the weight of the front door.



**DI SERIE
STANDARD**

**MOTORIZZATO
SERVO-DRIVE
SERVO-DRIVE
MOTORISED
(Opz.007)**

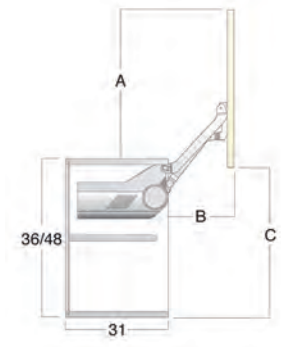

| | A | B | C |
|------|----|------|------|
| H 36 | 34 | 23,5 | 34,5 |
| H 48 | 43 | 28,5 | 43,5 |



COLONNE ARMADIO “NOOK” H 217 P 70,5 CON ANTE A SCOMPARSA

“NOOK” CLOSET COLUMNS H 217 D 70,5 WITH DOORS INWARDS

Le colonne armadio “Nook” con ante a scomparsa, consentono di inserire all’interno forno, frigo, tavolo e cassetti

“Nook” closet columns with pull-out doors allow to insert oven, fridge, table and drawer on the inside



COLONNE ARMADIO "NOOK" H 217 P 70,5 CON ANTE A SCOMPARSA

"NOOK" CLOSET COLUMNS H 217 D 70,5 WITH DOORS INWARDS

Il tavolo estraibile è disponibile nella versione inox o in laminato, nella finitura oak cognac

The pull-out table it's available in stainless steel version or laminate oak cognac finish



ZOCCOLO
H 6 centimetri
=
più volume di
contenimento

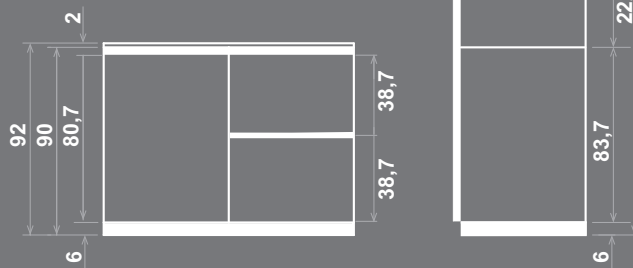

Con lo **zoccolo** ad altezza ridotta a 6 cm, si possono **guadagnare centimetri preziosi di contenimento**, dando alla cucina l'aspetto elegante di un living.

Valuable space has been saved by lowering the plinth to 6 cm, and so the kitchen will take on a stylish look such as a living room.



strutture carcasses



bianco (opz.001)
schiena e ripiano bianco
(opz.001)
white
white back panel and shelf



conchiglia (opz.8910)
schiena e ripiano conchiglia
(opz.8910)
shell
shell back panel and shelf



lavagna (opz.9620)
schiena e ripiano lavagna
(opz.9620)
slate grey
slate grey back panel and shelf



fango (opz.8860)
schiena e ripiano fango
(opz.8860)
mud
mud back panel and shelf



visone (opz.948M)
schiena e ripiano visone
(opz.948M)
mink
mink back panel and shelf



argilla (opz.9690)
schiena e ripiano argilla
(opz.9690)
clay
clay back panel and shelf

zoccoli in alluminio H 6 aluminium plinth H 6

di serie
standard



alluminio finitura urban
ossidato (opz.NU)
aluminium urban
oxidized finish (opt.NU)



alluminio finitura
brill (opz.412)
aluminium
brill finish (opt.412)



alluminio finitura
grafite (opz.421)
aluminium graphite
finish (opt.421)



alluminio finitura nichel
(opz.420)
aluminium nickel
finish (opt.420)

zoccoli in alluminio H 6 verniciati a polvere finitura opaca aluminum plinth height H 6 powder coated matt finish



alluminio finitura nero
(opz.7892)
aluminium
black finish (opt.7892)



alluminio finitura fumo
(opz.9531)
aluminium
smoke finish
(opt.9531)



alluminio finitura
bianco caldo (opz.7401)
aluminium warm white
finish (opt.7401)

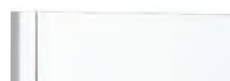

alluminio finitura
bianco assoluto
(opz.740S)
aluminium absolute
white finish (opt.740S)



alluminio finitura grigio
bromo (opz.9533)
aluminium bromine
grey finish (opt.9533)



alluminio finitura
silver dark (opz.9507)
aluminium dark silver
finish (opt.9507)



alluminio finitura
castoro (opz.8907)
aluminium beaver
finish (opt.8907)



alluminio finitura
cenere (opz.9547)
aluminium ash
finish (opt.9547)



alluminio finitura
grigio selce (opz.SE)
aluminium flint grey
finish (opt.SE)



alluminio finitura
conchiglia (opz.7403)
aluminium shell
finish (opt.7403)



alluminio finitura
ghisa (opz.9509)
aluminium cast iron
finish (opt.9509)



alluminio finitura
argilla (opz.9503)
aluminium clay
finish (opt.9503)



alluminio finitura
bistro (opz.9535)
aluminium bistro
finish (opt.9535)



alluminio finitura
ossido ottone
(opz.MEOT)
aluminium with
tarnished brass finish
(opt. MEOT)



alluminio finitura
ossido rame
(opz.MERM)
aluminium with
tarnished copper finish
(opt. MERM)

MODULARITÀ E COMPONENTI MODULARITÀ AND FITTING SOLUTIONS

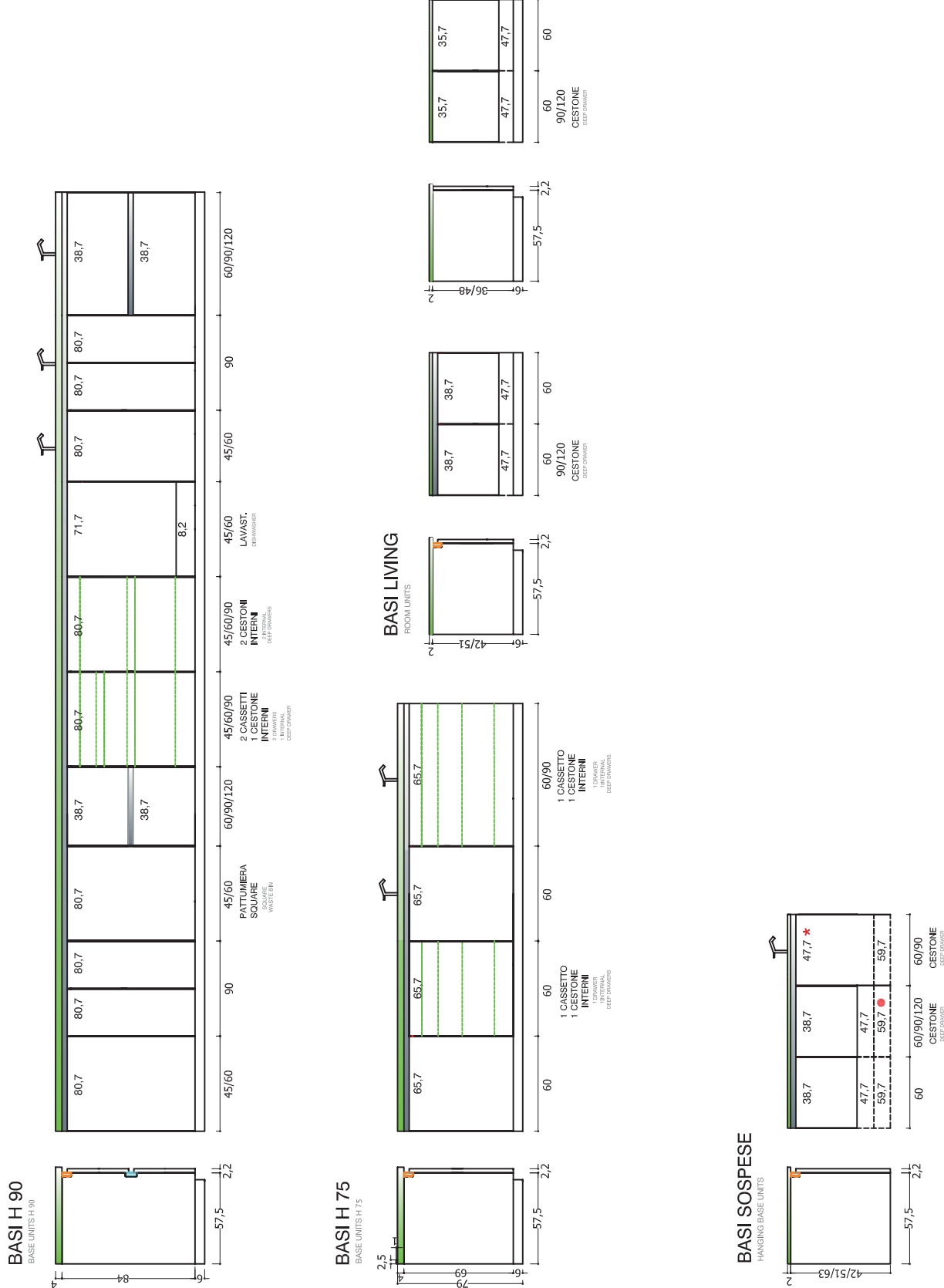

* SOLO 90 ONLY 90

● ESCLUSO 120 EXCLUDING 120

MODULARITÀ E COMPONIBILITÀ MODULARITY AND FITTING SOLUTIONS

COLONNE
COLUMNS

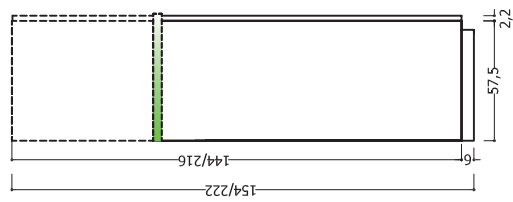

COLONNE FRIGO
FRIDGE COLUMNS

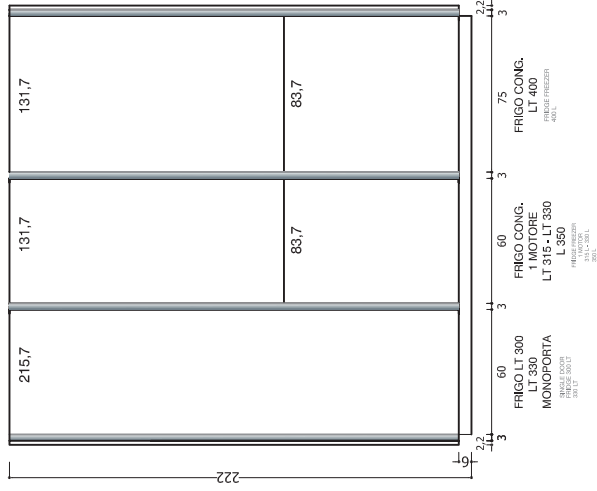
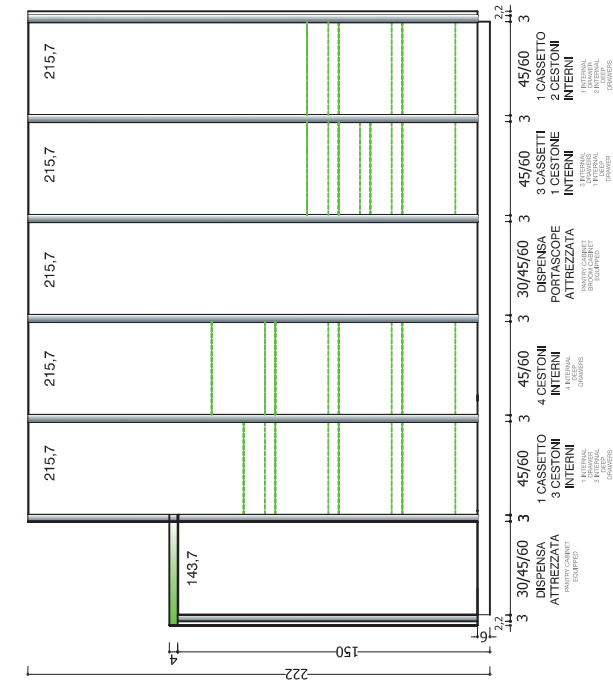
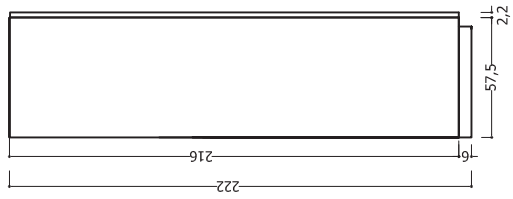

COLONNE FORNO
OVEN COLUMNS

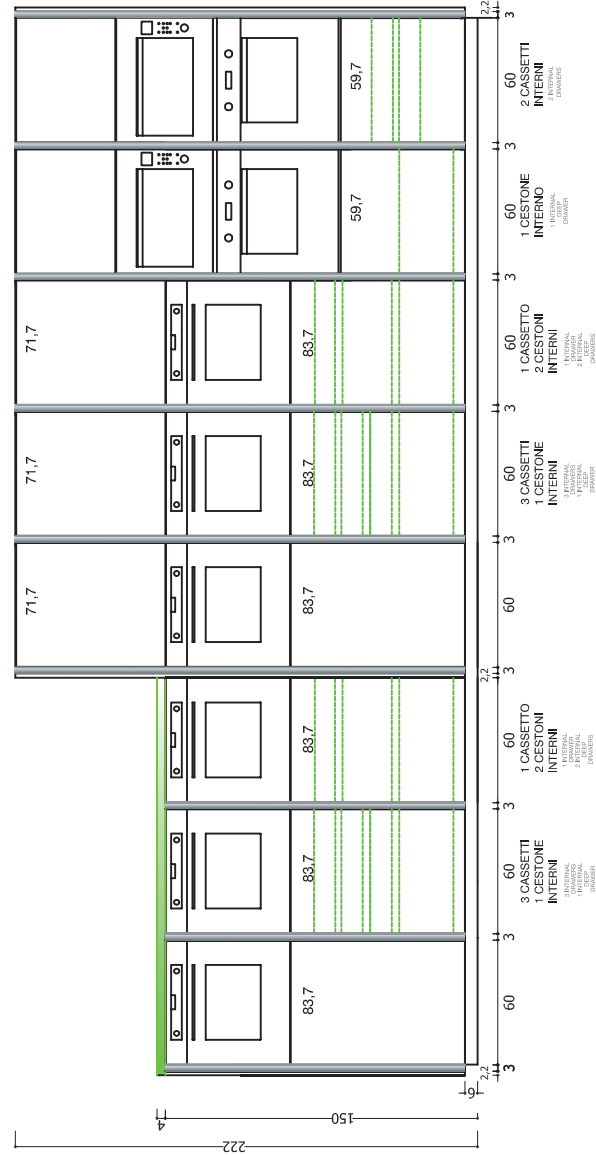
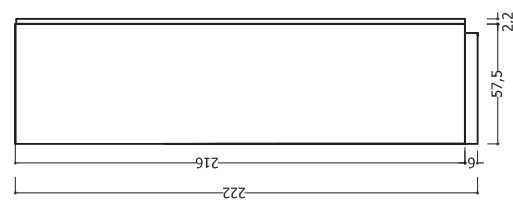



Con lo zoccolo ad altezza ridotta a 6 cm, si possono guadagnare centimetri preziosi di contenimento, dando alla cucina l'aspetto elegante di un living.

Valuable space has been saved by lowering the plinth to 6 cm, and so the kitchen will take on a stylish look such as a living room.



strutture carcasses



bianco (opz.001)
schiena e ripiano bianco
(opz.001)
white
white back panel and shelf



conchiglia (opz.8910)
schiena e ripiano conchiglia
(opz.8910)
shell
shell back panel and shelf



lavagna (opz.9620)
schiena e ripiano lavagna
(opz.9620)
slate grey
slate grey back panel and shelf



fango (opz.8860)
schiena e ripiano fango
(opz.8860)
mud
mud back panel and shelf



visone (opz.948M)
schiena e ripiano visone
(opz.948M)
mink
mink back panel and shelf



argilla (opz.9690)
schiena e ripiano argilla
(opz.9690)
clay
clay back panel and shelf

zoccoli in alluminio H 6 aluminium plinth H 6

di serie
standard



alluminio finitura urban
ossidato (opz.NU)
aluminium urban
oxidized finish (opt.NU)



alluminio finitura
brill (opz.412)
aluminium
brill finish (opt.412)



alluminio finitura
grafite (opz.421)
aluminium graphite
finish (opt.421)



alluminio finitura nichel
(opz.420)
aluminium nickel
finish (opt.420)

zoccoli in alluminio H 6 verniciati a polvere finitura opaca aluminum plinth height H 6 powder coated matt finish



alluminio finitura nero
(opz.7892)
aluminium
black finish (opt.7892)



alluminio finitura fumo
(opz.9531)
aluminium
smoke finish
(opt.9531)



alluminio finitura
bianco caldo (opz.7401)
aluminium warm white
finish (opt.7401)



alluminio finitura
bianco assoluto
(opz.740S)
aluminium absolute
white finish (opt.740S)



alluminio finitura grigio
bromo (opz.9533)
aluminium bromine
grey finish (opt.9533)



alluminio finitura
silver dark (opz.9507)
aluminium dark silver
finish (opt.9507)



alluminio finitura
castoro (opz.8907)
aluminium beaver
finish (opt.8907)



alluminio finitura
cenere (opz.9547)
aluminium ash
finish (opt.9547)



alluminio finitura
grigio selce (opz.SE)
aluminium flint grey
finish (opt.SE)



alluminio finitura
conchiglia (opz.7403)
aluminium shell
finish (opt.7403)



alluminio finitura
ghisa (opz.9509)
aluminium cast iron
finish (opt.9509)



alluminio finitura
argilla (opz.9503)
aluminium clay
finish (opt.9503)



alluminio finitura
bistro (opz.9535)
aluminium bistro
finish (opt.9535)



alluminio finitura
ossido ottone
(opz.MEOT)
aluminium with
tarnished brass finish
(opt. MEOT)



alluminio finitura
ossido rame
(opz.MERM)
aluminium with
tarnished copper finish
(opt. MERM)

MODULARITÀ E COMPONENTIBILITÀ MODULARITÀ AND FITTING SOLUTIONS

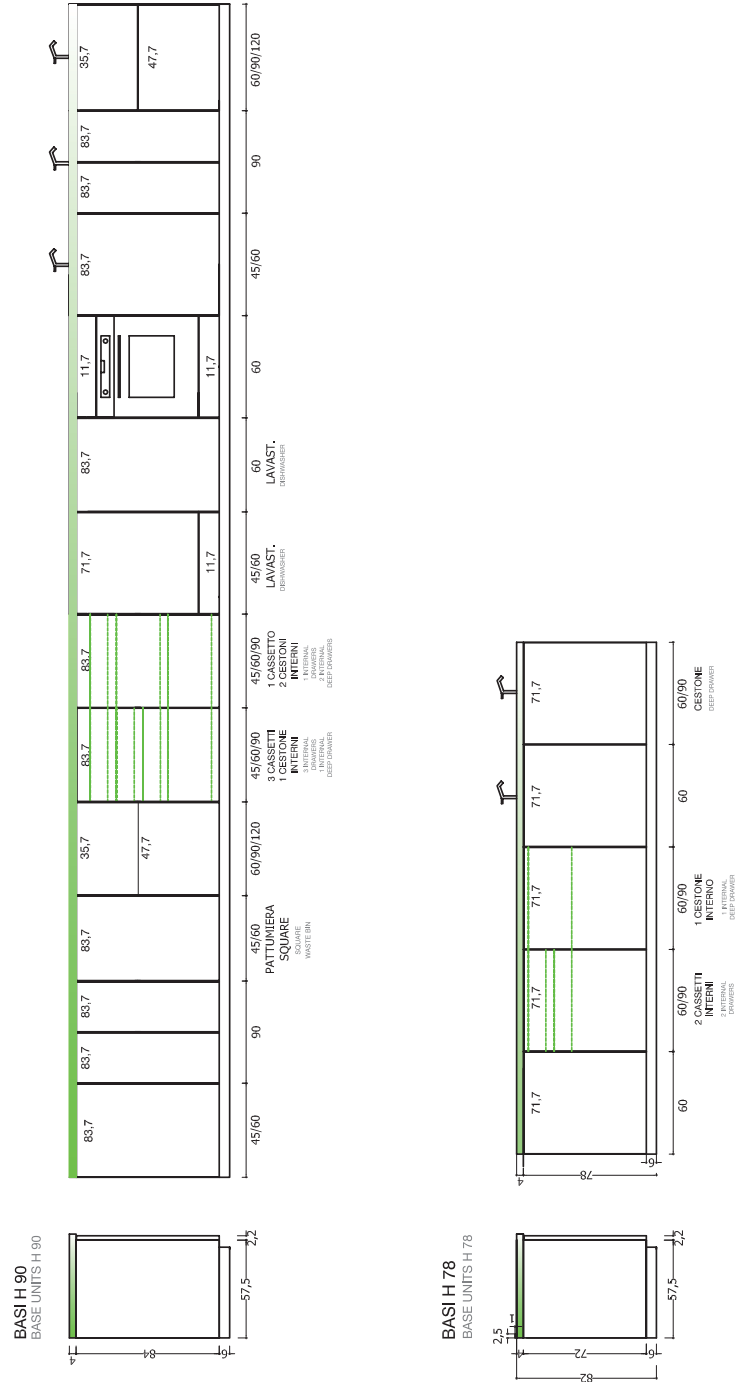

MODULARITÀ E COMPONIBILITÀ MODULARITY AND FITTING SOLUTIONS

