

ROUND



Con la nuova linea di cucine moderne ROUND, Lube propone una filosofia green, che si concretizza nelle ante realizzate in PET: materiale plastico totalmente rinnovabile e riciclabile. Le superfici innovative e performanti pensate per l'ambiente cucina si accostano ad una particolare attenzione per le tematiche ambientali, in un equilibrio vincente tra professionalità e rispetto per l'ambiente.

With the new ROUND modern kitchen model, Cucine Lube introduce a "green" philosophy, which takes shape in the PET door finish: a renewable and recyclable plastic material. The innovative and high-performance surfaces designed for the kitchen environment combine each other with a particular focus on environmental issues, for a winning balance between professionalism and respect for the environment.

Neck

Anta senza profilo per apertura con gola

Door without profile for finger rail opening



Lux

Anta con profilo per aperture con gola

Door with profile openings with finger rail

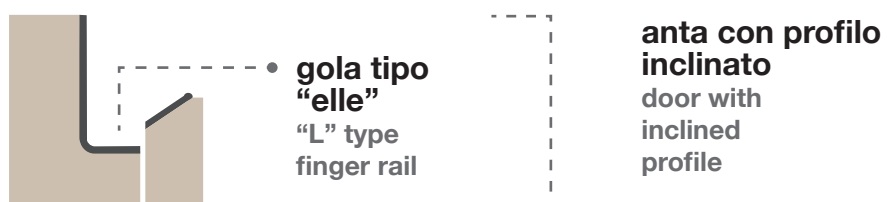

CARATTERISTICHE TECNICHE

ANTE E FRONTALI CASSETTI

anta sp.22 mm con pannello in mdf certificato (conforme **US EPA TSCA TITLE VI**) rivestita in foglia polimerica **PET*** effetto legno materico fiamma verticale, post-formata quattro lati con interno in melaminico, nei colori: larice bianco retro bianco (opz.2414N), larice grigio lava retro argilla (opz.2417N), larice conchiglia retro conchiglia (opz.2415N), larice visone retro visone (opz.2416N), larice nero retro lavagna (opz.2418N)

anta sp.22 mm con pannello in mdf certificato (conforme **US EPA TSCA TITLE VI**) rivestita in foglia polimerica **PET*** effetto legno fiamma verticale, post-formata quattro lati con interno in melaminico, nei colori: olmo sabbia retro visone (opz.5077), olmo tabacco retro fango (opz.5078), olmo scuro retro fango (opz.5079), olmo petrolio retro lavagna (opz.5080)

anta sp.22 mm con pannello in mdf certificato (conforme **US EPA TSCA TITLE VI**) rivestita in foglia polimerica **PET*** colore tinta unita opaco, post-formata quattro lati con interno in melaminico, nei colori: bianco ottico retro bianco (opz.7465), grigio fossena retro argilla (opz.9616), sabbia tenue retro conchiglia (opz.7718), daino retro visone (opz.9455), terra bruna retro fango (opz.8845), grigio lakis retro lavagna (opz.9618), rosso sedona retro visone (opz.8132), verde berillo retro visone (opz.8422), grigio velato retro bianco (opz.9600), blu dusty retro argilla (opz.8324)

anta sp.22 mm con pannello in mdf certificato (conforme **US EPA TSCA TITLE VI**) rivestita in foglia polimerica **PET*** materica effetto malta, post-formata quattro lati con interno in melaminico, nei colori: bianco assoluto retro bianco (opz.PM01N), grigio lava retro argilla (opz.PM04), sabbia retro conchiglia (opz.PM02N), visone retro visone (opz.PM03), grigio asfalto retro lavagna (opz.PM05)

*** il polietilenteraftelato, conosciuto sotto l'abbreviazione PET, è una materia sintetica moderna, ecologica e riciclabile al 100%. Le principali caratteristiche che lo diversificano dalle tradizionali materie plastiche sono la flessibilità e l'eccellente stabilità dimensionale che lo rendono inalterabile nel tempo. L'elevata resistenza al calore, all'usura ed all'invecchiamento termico fanno del PET uno dei materiali più innovativi ed orientati al futuro.**

GOLE E PROFILI

vedi pag.16-17

STRUTTURE

ANTE: larice grigio lava retro argilla, malta grigio lava retro argilla, grigio fossena opaco retro argilla, blu dusty opaco retro argilla di serie : nobilitato argilla (opz.9690) schiena e ripiano argilla (opz.9690)

ANTE: larice conchiglia retro conchiglia, malta sabbia retro conchiglia, sabbia tenue opaco retro conchiglia di serie : nobilitato conchiglia (opz.8910) schiena e ripiano conchiglia (opz.8910)

ANTE: larice bianco retro bianco, malta bianco assoluto retro bianco, bianco ottico opaco retro bianco, grigio velato opaco retro bianco di serie : nobilitato bianco (opz.001) schiena e ripiano bianco (opz.001)

ANTE: larice visone retro visone, malta visone retro visone, daino opaco retro visone, olmo sabbia retro visone, rosso sedona opaco retro visone, verde berillo opaco retro visone di serie : nobilitato visone (opz.948M) schiena e ripiano visone (opz.948M)

ANTE: larice nero retro lavagna, malta grigio asfalto retro lavagna, olmo petrolio retro lavagna, grigio lakis retro lavagna di serie : nobilitato lavagna (opz.9620) schiena e ripiano lavagna (opz.9620)

ANTE: olmo tabacco retro fango, olmo scuro retro fango, terra bruna retro fango di serie : nobilitato fango (opz.8860) schiena e ripiano fango (opz.8860)



*per componenti si intendono tutte le strutture, alcuni ante e alcuni complementi del modello.



GREENGUARD
LE STRUTTURE DELLE CUCINE SONO CONTRADDISTINTE DALLA CERTIFICAZIONE GREENGUARD PER SODDISFARE GLI STANDARD PIU' RIGOROSI IN TERMINI DI LIVELLI DI EMISSIONE DI COMPOSTI ORGANICI VOLATILI (COV).

MENSOLE

vedi pag.54

ZOCCOLI

vedi pag.55



TECHNICAL FEATURES

DOORS AND DRAWER FRONTS

22 mm-thick door with panel in certified MDF (compliant with **US EPA TSCA TITLE VI**) coated with polymeric sheet **PET*** textured wood effect vertical grain, post-formed on four sides with melamine interior, in these colours: white larch with white rear (opt.2414N), lava grey larch with clay rear (opt.2417N), shell larch with shell rear (opt.2415N), mink larch with mink rear (opt.2416N), black larch with blackboard rear (opt.2418N)

22 mm-thick door with panel in certified MDF (compliant with **US EPA TSCA TITLE VI**) coated with polymeric sheet **PET*** wood effect vertical grain, post-formed on four sides with melamine interior, in these colours: sand elm with mink rear (opt.5077), tobacco elm with mud rear (opt.5078), dark elm with mud rear (opt.5079), oil elm with blackboard rear (opt.5080)

22 mm-thick door with panel in certified MDF (compliant with **US EPA TSCA TITLE VI**) coated with polymeric sheet **PET*** matt solid colour, post-formed on four sides with melamine interior, in these colours: optical white with white rear (opt.7465), fossena grey with clay rear (opt.9616), soft sand with shell rear (opt.7718), deer with mink rear (opt.9455), brown earth with mud rear (opt.8845), lakis grey with blackboard rear (opt.9618), sedona red with mink rear (opt.8132), beryl green with mink rear (opt.8422), veiled grey with white rear (opt.9600), blu dusty with clay rear (opt.8324)

22 mm-thick door with panel in certified MDF (compliant with **US EPA TSCA TITLE VI**) coated with polymeric sheet **PET*** textured mortar effect, post-formed on four sides with melamine interior, in these colours: absolute white with white rear (opt.PM01N), lava grey with clay rear (opt.PM04), sand with shell rear (opt.PM02N), mink with mink rear (opt.PM03), grey asphalt with blackboard rear (opt.PM05)

*** polyethylene terephthalate, abbreviated as PET, is a modern synthetic material, environmentally friendly and 100% recyclable. The main features that distinguish it from traditional plastics are its flexibility and excellent dimensional stability, which renders it unalterable over time. Its high resistance to heat, wear and thermal ageing makes PET one of the most innovative, future-oriented materials.**

FINGER RAILS AND PROFILES

see page 16-17

CARCASSES

DOORS: lava grey larch with clay rear, lava grey mortar with clay rear, matt fossena grey with clay rear, matt blu dusty with clay rear
standard: melamine-coated clay (opt.9690) clay back panel and shelf (opt.9690)

DOORS: shell larch with shell rear, sand mortar with shell rear, matt soft sand with shell rear
standard: melamine-coated shell (opt.8910) shell back panel and shelf (opt.8910)

DOORS: white larch with white rear, absolute white mortar with white rear, matt optical white with white rear, matt veiled grey with white rear
standard: melamine-coated white (opt.001), white back panel and shelf (opt.001)

DOORS: mink larch with mink rear, mink mortar with mink rear, matt deer with mink rear, sand elm with mink rear, matt sedona red with mink rear, matt beryl green with mink rear
standard: melamine-coated mink (opt.948M) mink back panel and shelf (opt.948M)

DOORS: black ash with blackboard rear, grey asphalt mortar with blackboard rear, oil elm with blackboard rear, matt lakis grey with blackboard rear
standard: melamine-coated slate grey (opt.9620) slate grey back panel and shelf (opt.9620)

DOORS: tobacco elm with mud rear, dark elm with mud rear, matt brown earth with mud rear
standard: melamine-coated mud (opt.8860) mud back panel and shelf (opt.8860)

SHELVES

see page 54

PLINTHS

see page 55



Round

Neck

cod. **N15**

LUX

cod. **L15**

SP. 22 MM TH. 22 MM

ante effetto legno materico post-formate 4 lati
doors with textured wood effect post-formed on 4 sides



larice bianco
retro bianco (opz.2414N)
white larch with white rear



larice grigio lava
retro argilla (opz.2417N)
lava grey larch with clay rear
N.B.: disponibile a partire da Novembre 2022
Note: available from November 2022



larice conchiglia
retro conchiglia (opz.2415N)
shell larch with shell rear
N.B.: disponibile a partire da Novembre 2022
Note: available from November 2022



larice visone
retro visone (opz.2416N)
mink larch with mink rear
N.B.: disponibile a partire da Novembre 2022
Note: available from November 2022



larice nero
retro lavagna (opz.2418N)
black larch with blackboard rear

ante effetto legno post-formate 4 lati
doors with wood effect post-formed on 4 sides



olmo sabbia
retro visone (opz.5077)
sand elm with mink rear



olmo tabacco
retro fango (opz.5078)
tobacco elm with mud rear



olmo scuro
retro fango (opz.5079)
dark elm with mud rear



olmo petrolio
retro lavagna (opz.5080)
oil elm with blackboard rear

Neck

LUX



particolare anta con incavo
presa maniglia su bordo
door detail with recessed
handle grip at edge



particolare anta profilo curvo
door with curved profile detail



particolare anta profilo ad "ELLE"
door with "L" shaped profile detail



particolare anta profilo inclinato
door with inclined profile detail

Round

Neck

cod. **N15**

LUX

cod. **L15**

SP. 22 MM TH. 22 MM

ante tinta unita opache post-formate 4 lati
doors with solid matt colour post-formed 4 sides



bianco ottico
retro bianco (opz.7465)
optical white with white rear



grigio fossena
retro argilla (opz.9616)
fossena grey with clay rear

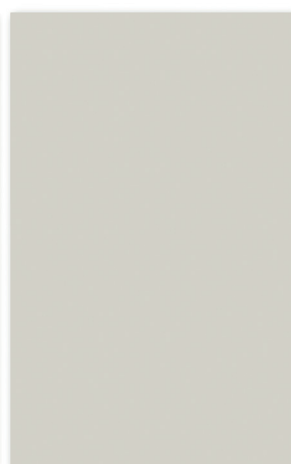

sabbia tenue
retro conchiglia (opz.7718)
soft sand with shell rear



daino
retro visone (opz.9455)
deer with mink rear



terra bruna
retro fango (opz.8845)
brown earth with mud rear

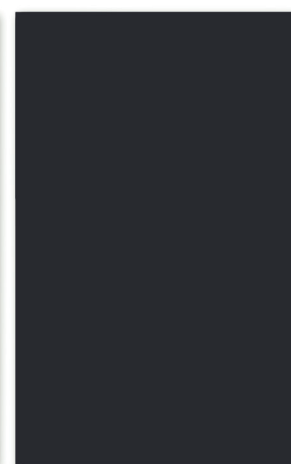

grigio lakis
retro lavagna (opz.9618)
lakis grey with blackboard rear



rosso sedona
retro visone (opz.8132)
sedona red with mink rear



verde berillo
retro visone (opz.8422)
beryl green with mink rear



grigio velato
retro bianco (opz.9600)
veiled grey with white rear



blu dusty
retro argilla (opz.8324)
blu dusty with clay rear

Neck

LUX



particolare anta con incavo
presa maniglia su bordo
door detail with recessed
handle grip at edge



particolare anta profilo curvo
door with curved profile detail



particolare anta profilo ad "ELLE"
door with "L" shaped profile detail



particolare anta profilo inclinato
door with inclined profile detail

Round

Neck

cod. **N15**

LUX

cod. **L15**

SP. 22 MM TH. 22 MM

ante effetto malta materico post-formate 4 lati
doors with textured mortar effect post-formed 4 sides



malta bianco assoluto
retro bianco (opz.PM01N)
absolute white mortar with
white rear



malta grigio lava
retro argilla (opz.PM04)
lava grey mortar with
clay rear

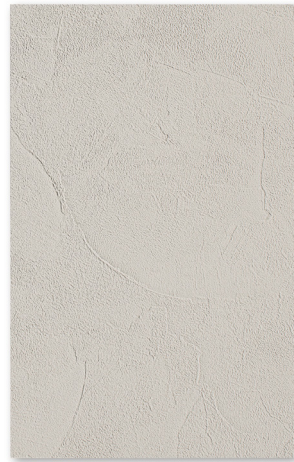

malta sabbia
retro conchiglia (opz.PM02N)
sand mortar with shell rear



malta visone
retro visone (opz.PM03)
mink mortar with mink rear



malta grigio asfalto
retro lavagna (opz.PM05)
grey asphalt mortar with
blackboard rear

Neck

LUX



particolare anta con incavo
presa maniglia su bordo
door detail with recessed
handle grip at edge



particolare anta profilo curvo
door with curved profile detail



particolare anta profilo ad "ELLE"
door with "L" shaped profile detail



particolare anta profilo inclinato
door with inclined profile detail

SP. 22 MM

CARATTERISTICHE TECNICHE

ANTE E FRONTALI CASSETTI

anta sp.22 mm con pannello in mdf certificato (conforme **US EPA TSCA TITLE VI**) rivestita in foglia polimerica **PET*** effetto legno materico fiamma verticale con lavorazione "Rayè" post-formata quattro lati con interno in melaminico, nei colori: larice bianco retro bianco (opz.2414R), larice grigio lava retro argilla (opz.2417R), larice conchiglia retro conchiglia (opz.2415R), larice visone retro visone (opz.2416R), larice nero retro lavagna (opz.2418R)

anta sp.22 mm con pannello in mdf certificato (conforme **US EPA TSCA TITLE VI**) rivestita in foglia polimerica **PET*** effetto legno fiamma verticale con lavorazione "Rayè" post-formata quattro lati con interno in melaminico, nei colori: olmo sabbia retro visone (opz.5077R), olmo tabacco retro fango (opz.5078R), olmo scuro retro fango (opz.5079R), olmo petrolio retro lavagna (opz.5080R)

anta sp.22 mm con pannello in mdf certificato (conforme **US EPA TSCA TITLE VI**) rivestita in foglia polimerica **PET*** colore tinta unita opaco con lavorazione "Rayè" post-formata quattro lati con interno in melaminico, nei colori: bianco ottico retro bianco (opz.7465R), grigio fossena retro argilla (opz.9616R), sabbia tenue retro conchiglia (opz.7718R), daino retro visone (opz.9455R), terra bruna retro fango (opz.8845R), grigio lakis retro lavagna (opz.9618R), rosso sedona retro visone (opz.8132R), verde berillo retro visone (opz.8422R), grigio velato retro bianco (opz.9600R), blu dusty retro argilla (opz.8324R)

*** il polietilenteraftelato, conosciuto sotto l'abbreviazione PET, è una materia sintetica moderna, ecologica e riciclabile al 100%. Le principali caratteristiche che lo diversificano dalle tradizionali materie plastiche sono la flessibilità e l'eccellente stabilità dimensionale che lo rendono inalterabile nel tempo. L'elevata resistenza al calore, all'usura ed all'invecchiamento termico fanno del PET uno dei materiali più innovativi ed orientati al futuro.**

GOLE E PROFILI

vedi pag.16-17

STRUTTURE

ANTE: larice grigio lava retro argilla, grigio fossena opaco retro argilla, blu dusty opaco retro argilla di serie : nobilitato argilla (opz.9690) schiena e ripiano argilla (opz.9690)

ANTE: larice conchiglia retro conchiglia, sabbia tenue opaco retro conchiglia di serie : nobilitato conchiglia (opz.8910) schiena e ripiano conchiglia (opz.8910)

ANTE: larice bianco retro bianco, bianco ottico opaco retro bianco, grigio velato opaco retro bianco di serie : nobilitato bianco (opz.001) schiena e ripiano bianco (opz.001)

ANTE: larice visone retro visone, daino opaco retro visone, olmo sabbia retro visone, rosso sedona opaco retro visone, verde berillo opaco retro visone di serie : nobilitato visone (opz.948M) schiena e ripiano visone (opz.948M)

ANTE: larice nero retro lavagna, olmo petrolio retro lavagna, grigio lakis retro lavagna di serie : nobilitato lavagna (opz.9620) schiena e ripiano lavagna (opz.9620)

ANTE: olmo tabacco retro fango, olmo scuro retro fango, terra bruna retro fango di serie : nobilitato fango (opz.8860) schiena e ripiano fango (opz.8860)



*Per componenti si intendono tutte le strutture, alcune ante e alcuni complementi del modello.



GREENGUARD
LE STRUTTURE DELLE CUCINE SONO CONTRADDISTINTE DALLA CERTIFICAZIONE GREENGUARD PER SODDISFARE GLI STANDARD PIÙ RIGOROSI IN TERMINI DI LIVELLI DI EMISSIONE DI COMPOSTI ORGANICI VOLATILI (COV).

MENSOLE

vedi pag.54

ZOCCOLI

vedi pag.55



TH. 22 MM

TECHNICAL FEATURES

DOORS AND DRAWER FRONTS

22 mm-thick door with panel in certified MDF (compliant with **US EPA TSCA TITLE VI**) coated with polymeric sheet **PET*** textured wood effect vertical grain with processing "Rayè" post-formed on four sides with melamine interior, in these colours: white larch with white rear (opt.2414R), lava grey larch with clay rear (opt.2417R), shell larch with shell rear (opt.2415R), mink larch with mink rear (opt.2416R), black larch with blackboard rear (opt.2418R)

22 mm-thick door with panel in certified MDF (compliant with **US EPA TSCA TITLE VI**) coated with polymeric sheet **PET*** wood effect vertical grain with processing "Rayè" post-formed on four sides with melamine interior, in these colours: sand elm with mink rear (opt.5077R), tobacco elm with mud rear (opt.5078R), dark elm with mud rear (opt.5079R), oil elm with blackboard rear (opt.5080R)

22 mm-thick door with panel in certified MDF (compliant with **US EPA TSCA TITLE VI**) coated with polymeric sheet **PET*** matt solid colour with processing "Rayè" post-formed on four sides with melamine interior, in these colours: optical white with white rear (opt.7465R), fossena grey with clay rear (opt.9616R), soft sand with shell rear (opt.7718R), deer with mink rear (opt.9455R), brown earth with mud rear (opt.8845R), lakis grey with blackboard rear (opt.9618R), sedona red with mink rear (opt.8132R), beryl green with mink rear (opt.8422R), veiled grey with white rear (opt.9600R), blu dusty with clay rear (opt.8324R)

*** polyethylene terephthalate, abbreviated as PET, is a modern synthetic material, environmentally friendly and 100% recyclable. The main features that distinguish it from traditional plastics are its flexibility and excellent dimensional stability, which renders it unalterable over time. Its high resistance to heat, wear and thermal ageing makes PET one of the most innovative, future-oriented materials.**

FINGER RAILS AND PROFILES

[see page 16-17](#)

CARCASSES

DOORS: lava grey larch with clay rear, matt fossena grey with clay rear, matt blu dusty with clay rear
standard: melamine-coated clay (opt.9690) clay back panel and shelf (opt.9690)

DOORS: shell larch with shell rear, matt soft sand with shell rear
standard: melamine-coated shell (opt.8910) shell back panel and shelf (opt.8910)

DOORS: white larch with white rear, matt optical white with white rear, matt veiled grey with white rear
standard: melamine-coated white (opt.001), white back panel and shelf (opt.001)

DOORS: mink larch with mink rear, matt deer with mink rear, sand elm with mink rear, matt sedona red with mink rear, matt beryl green with mink rear
standard: melamine-coated mink (opt.948M) mink back panel and shelf (opt.948M)

DOORS: black ash with blackboard rear, oil elm with blackboard rear, matt lakis grey with blackboard rear
standard: melamine-coated slate grey (opt.9620) slate grey back panel and shelf (opt.9620)

DOORS: tobacco elm with mud rear, dark elm with mud rear, matt brown earth with mud rear
standard: melamine-coated mud (opt.8860) mud back panel and shelf (opt.8860)

SHELVES

[see page 54](#)

PLINTHS

[see page 55](#)



SP. 22 MM TH. 22 MM

ante effetto legno materico post-formate 4 lati
doors with textured wood effect post-formed on 4 sides

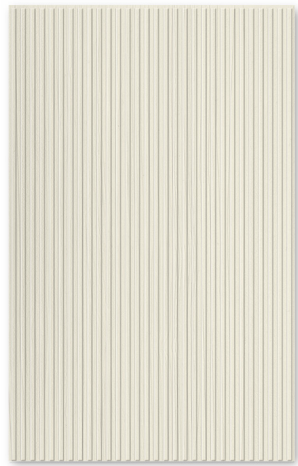

larice bianco
retro bianco (opz.2414N)
white larch with white rear

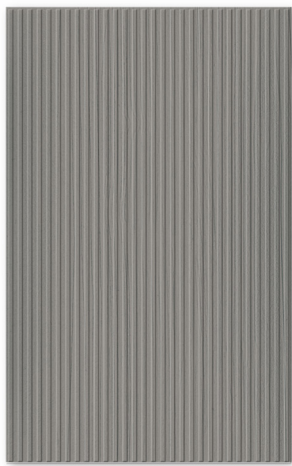

larice grigio lava
retro argilla (opz.2417N)
lava grey larch with clay rear
N.B.: disponibile a partire da Novembre 2022
Note: available from November 2022



larice conchiglia
retro conchiglia (opz.2415N)
shell larch with shell rear
N.B.: disponibile a partire da Novembre 2022
Note: available from November 2022

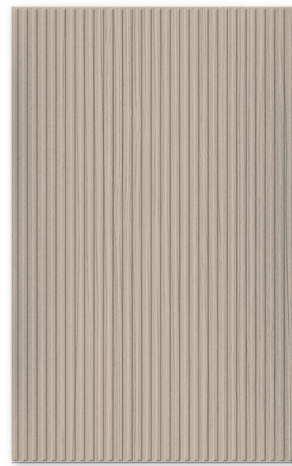

larice visone
retro visone (opz.2416N)
mink larch with mink rear
N.B.: disponibile a partire da Novembre 2022
Note: available from November 2022

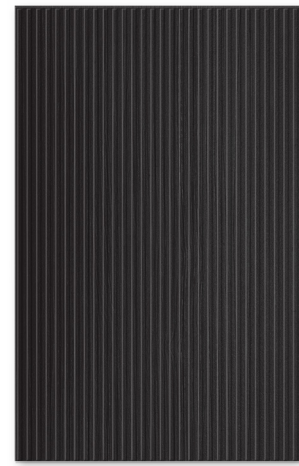

larice nero
retro lavagna (opz.2418N)
black larch with blackboard rear

ante effetto legno post-formate 4 lati
doors with wood effect post-formed on 4 sides



olmo sabbia
retro visone (opz.5077)
sand elm with mink rear



olmo tabacco
retro fango (opz.5078)
tobacco elm with mud rear



olmo scuro
retro fango (opz.5079)
dark elm with mud rear

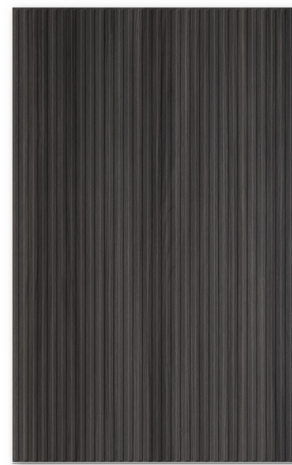

olmo petrolio
retro lavagna (opz.5080)
oil elm with blackboard rear

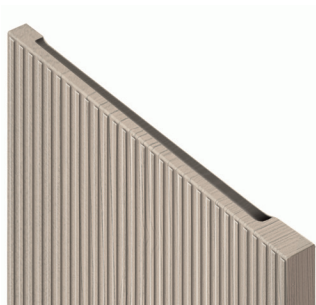

particolare anta con incavo
presa maniglia su bordo
door detail with recessed
handle grip at edge

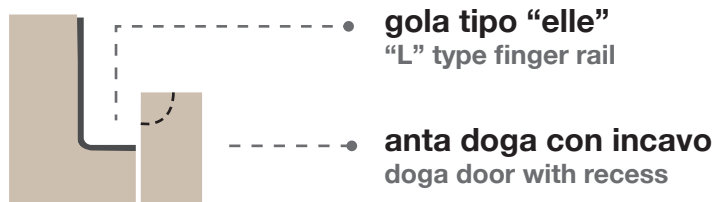

Round Rayè

Neck

cod. N17

SP. 22 MM TH. 22 MM

ante tinta unita opache post-formate 4 lati
doors with solid matt colour post-formed 4 sides

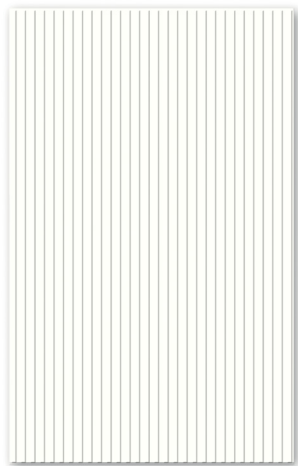

bianco ottico
retro bianco (opz.7465R)
optical white with white rear

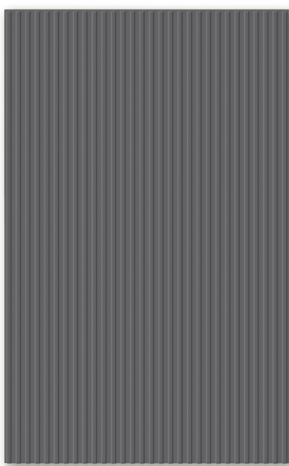

grigio fossena
retro argilla (opz.9616R)
fossena grey with clay rear



sabbia tenue
retro conchiglia (opz.7718R)
soft sand with shell rear

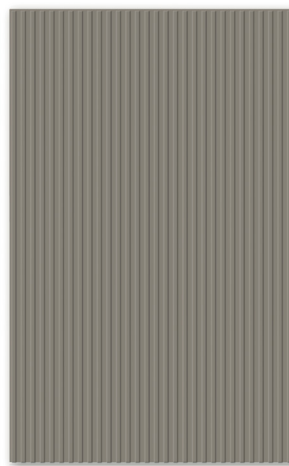

daino
retro visone (opz.9455R)
deer with mink rear

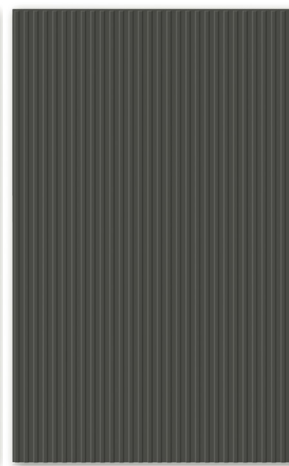

terra bruna
retro fango (opz.8845R)
brown earth with mud rear

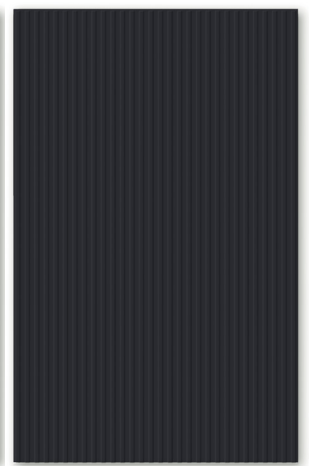

grigio lakis
retro lavagna (opz.9618R)
lakis grey with blackboard rear

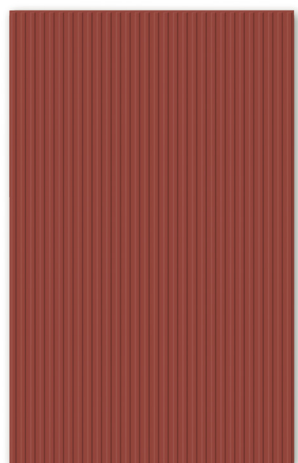

rosso sedona
retro visone (opz.8132R)
sedona red with mink rear

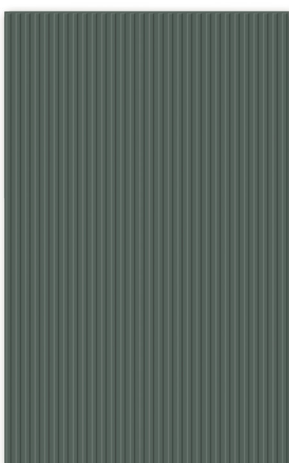

verde berillo
retro visone (opz.8422R)
beryl green with mink rear

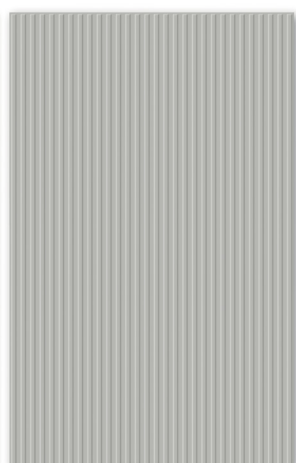

grigio velato
retro bianco (opz.9600R)
veiled grey with white rear

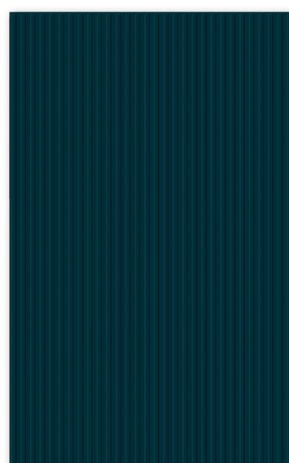

blu dusty
retro argilla (opz.8324R)
blu dusty with clay rear

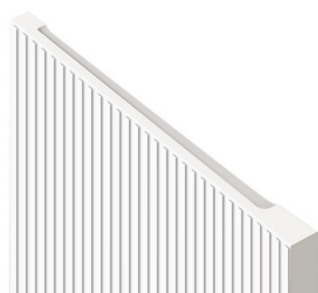

particolare anta con incavo
presa maniglia su bordo
door detail with recessed
handle grip at edge

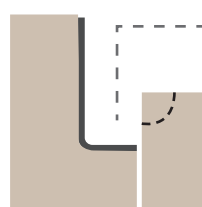

gola tipo "elle"
"L" type finger rail

anta doga con incavo
doga door with recess

Apertura con gola / Opening by finger rail

Neck

gola tipo "elle"
"L" type finger rail

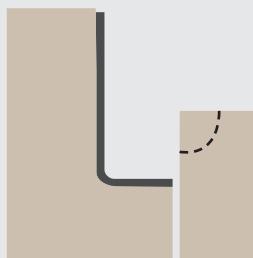

**Anta neck con incavo
per gola tipo "elle"**
neck door with recess
for "L" type finger rail

Lux

gola tipo "elle"
"L" type finger rail

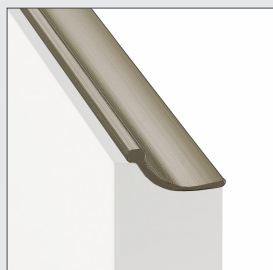

**Anta con
profilo curvo**
Door with curved
profile

(opz. P C + cod. colore)

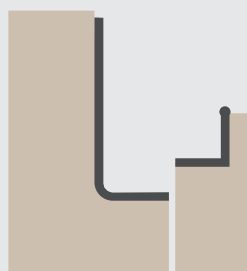

**Anta con
profilo ad "elle"**
door with "L"
shaped profile

(opz. P L + cod. colore)

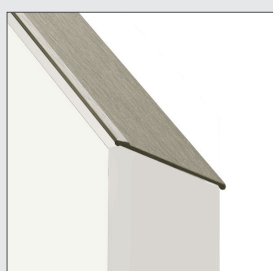

**Anta con
profilo inclinato**
door with inclined
profile

(opz. P I + cod. colore)

Finiture gole e profili / Finger rails and profiles finishes

Neck - Lux

**Finitura gola e profilo
spazzolato**
Finger rail and profile
brushed finish



titanio ossidato
(opz.414)
titanium oxidized
(opt.414)

**Finiture gole e profili
verniciati a polvere
opachi**
Matt finger rails
and profiles powder
coated finishes

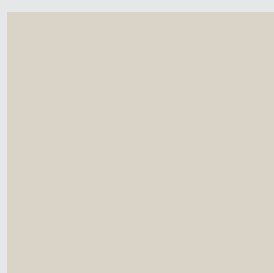

conchiglia (opz.7403)
shell (opt.7403)

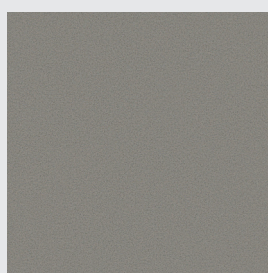

grigio selce (opz.SEL)
flint grey (opt.SEL)

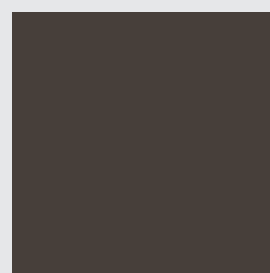

ghisa (opz.9509)
cast iron (opt.9509)

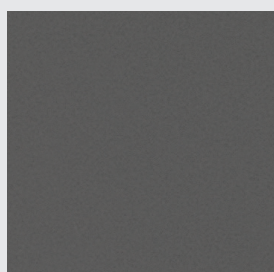

silver dark (opz.9507)
dark silver (opt.9507)

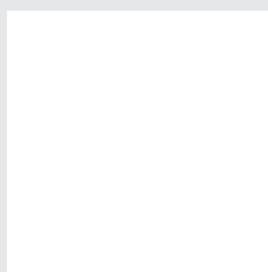

bianco assoluto
(opz.740S)
absolute white
(opt.740S)

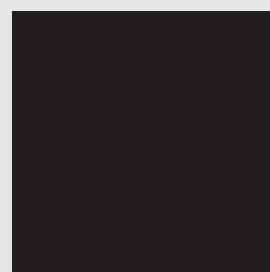



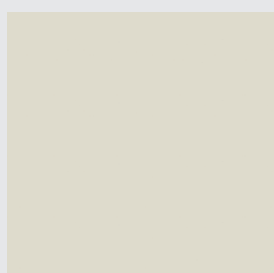

nero (opz.7892)
black (opt.7892)



lino (opz.W770)
linen (opt.W770)

GOLA "ELLE" ORIZZONTALE SOTTOTOP

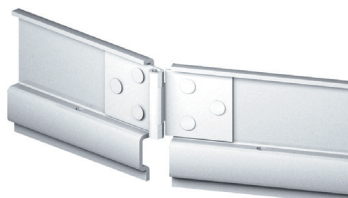
UNDERMOUNT HORIZONTAL "ELLE" FINGER RAIL

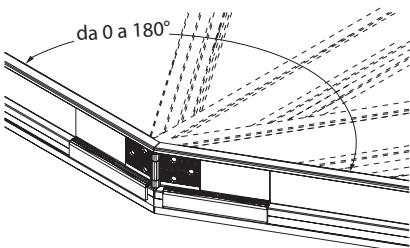
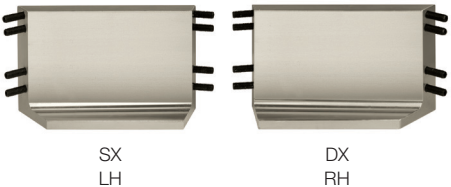

	COD.			COD.		
<p>Gola sottotop tipo "A" Type "A" undermount finger rail</p>  <p style="text-align: right;">al ml per lm</p>	G950010			<p>Angolo interno a 90° per gola tipo "A" 90° interior corner for "A" type finger rail</p>  <p style="text-align: right;">cadauno each</p>	G950050	
<p>Terminale aperto dx o sx per gola tipo "A" da utilizzare a fine composizione RH or LH open end for type "A" finger rail to be placed at the end of the composition</p>  <p style="text-align: right;">terminale DX RH end terminale SX LH end</p>	G950021			<p>Angolare con snodo per unione fuori squadra per gola tipo "A" Corner piece with joint for out-of-plumb joining for type "A" finger rail</p> 		
	G950022					
<p>Terminale chiuso dx o sx per gola tipo "A" da utilizzare solo tra basi e colonne RH or LH closure for type "A" finger rail to be placed only between base units and column</p>  <p style="text-align: right;">terminale DX RH end terminale SX LH end</p>	G950031			 <p style="text-align: center;">da 0 a 180°</p>		
	G950032					G950060
<p>Coppia angolari per kit raccordo base angolo 110x110 Couple corner piece for fitting kit corner base unit 110x110</p>  <p style="text-align: center;">SX LH DX RH</p> <p style="text-align: right;">in alluminio aluminium angolare DX RH corner piece angolare SX LH corner piece</p>	G950058					
	G950059					

GOLA "ELLE" ORIZZONTALE INTERMEDIA

INTERMEDIATE HORIZONTAL "ELLE" FINGER RAIL

GOLE "ELLE" VERTICALI PER COLONNE

VERTICAL "ELLE" FINGER RAILS FOR COLUMNS

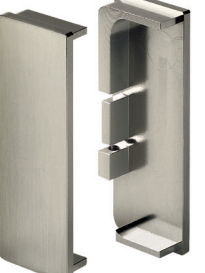
	COD.	
<p>Gola intermedia tipo "B"</p> <p>Type "B" intermediate finger rail</p> 	G950110	al ml per lm
<p>Terminale aperto dx o sx per gola tipo "B" da utilizzare a fine composizione</p> <p>RH or LH open end for type "B" finger rail to be placed at the end of the composition</p> 	G950121	terminale DX RH end
	G950122	terminale SX LH end
<p>Terminale chiuso dx o sx per gola tipo "B" da utilizzare solo tra cassettiere e lavastoviglie/colonne</p> <p>RH or LH closure for type "B" finger rail to be placed only between drawer units and dishwasher/columns</p> 	G950131	terminale DX RH end
	G950132	terminale SX LH end

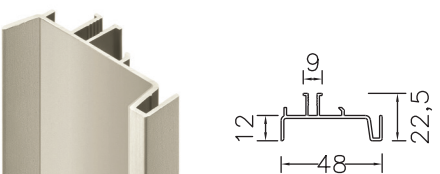
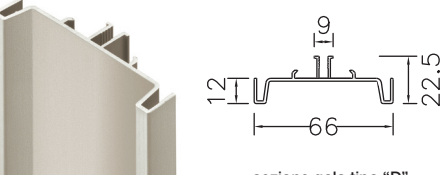
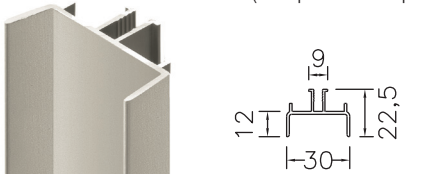
	COD.	
<p>Mezza gola verticale tipo "C" (completa di distanziale)</p> <p>Type "C" half vertical finger rail (complete with spacer)</p>  <p>sezione mezza gola tipo "C" cross section of type "C" finger rail</p>	G950310	Piedi H 13 H 96
	G950330	H 132
	G950350	H 204
	G950370	H 228
	G950320	Piedi H 6 H 108
	G950340	H 144
	G950360	H 216
<p>Gola verticale intermedia tipo "D" (completa di distanziale)</p> <p>Type "D" intermediate vertical finger rail (complete with spacer)</p>  <p>sezione gola tipo "D" cross section of type "D" finger rail</p>	G950410	Piedi H 13 H 96
	G950430	H 132
	G950450	H 204
	G950470	H 228
	G950420	Piedi H 6 H 108
	G950440	H 144
	G950460	H 216
<p>Gola verticale laterale tipo "E" (completa di distanziale)</p> <p>Type "E" lateral vertical finger rail (complete with spacer)</p>  <p>sezione gola tipo "E" cross section of type "E" finger rail</p>	G950510	Piedi H 13 H 96
	G950530	H 132
	G950550	H 204
	G950570	H 228
	G950520	Piedi H 6 H 108
	G950540	H 144
	G950560	H 216

NOZIONI UTILI - gole "elle" orizzontali per basi

USEFUL INFORMATION - HORIZONTAL "ELLE" FINGER RAILS FOR BASE UNITS

VISTA FRONTALE ZOCCOLO H 13 PER BASI H 88

FRONT VIEW PLINTH H 13 FOR BASE UNITS H 88

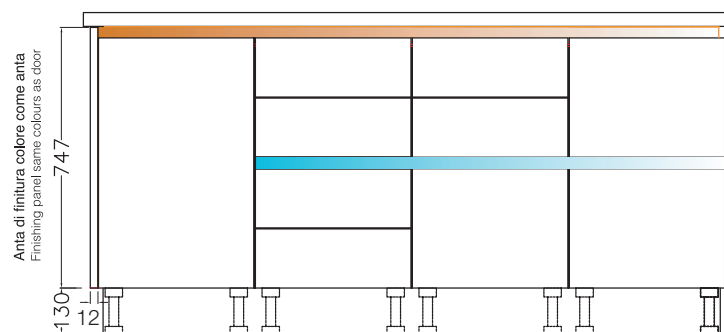
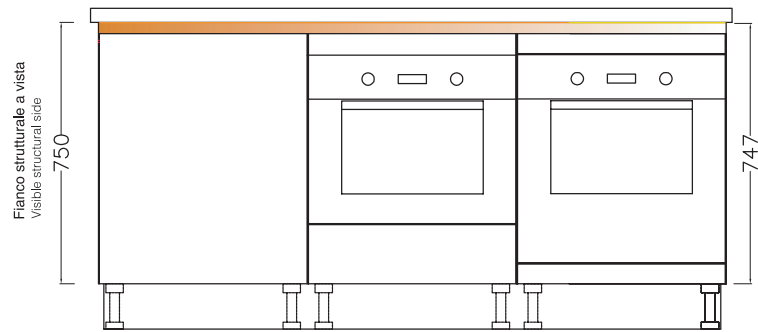

VISTA FRONTALE ZOCCOLO H 6 PER BASI H 90

FRONT VIEW PLINTH H 6 FOR BASE UNITS H 90

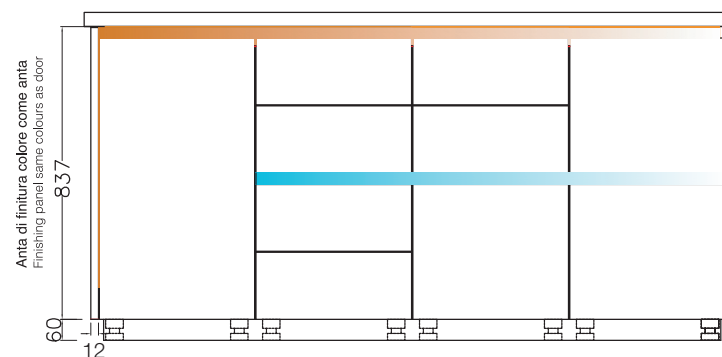
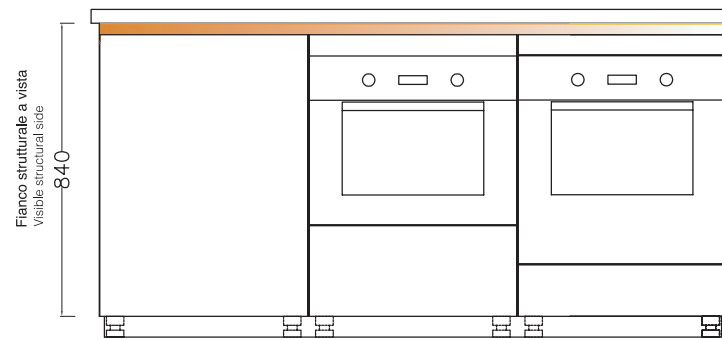

VISTA LATERALE (sezione) ZOCCOLO H 13 PER BASI H 88

SIDE VIEW (CROSS SECTION) PLINTH H 13 FOR BASE UNITS H 88

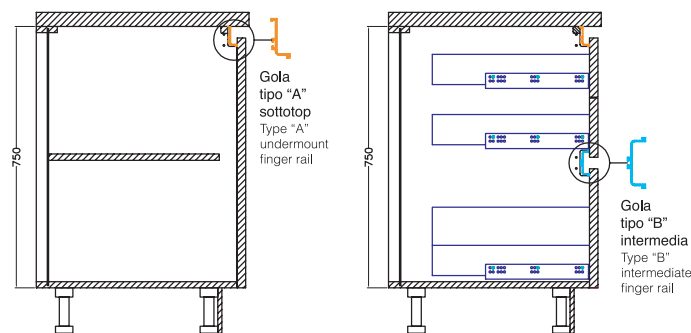

VISTA LATERALE (sezione) ZOCCOLO H 6 PER BASI H 90

SIDE VIEW (CROSS SECTION) PLINTH H 6 FOR BASE UNITS H 90

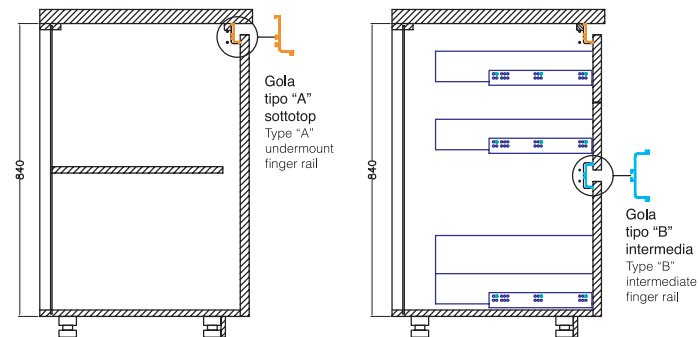

VISTA DALL'ALTO

TOP VIEW

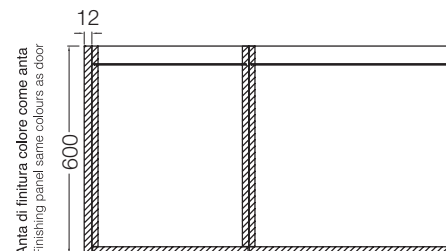
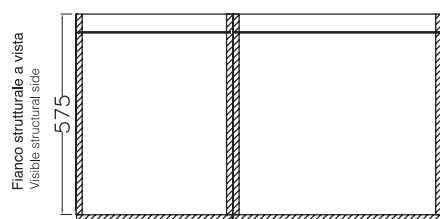

Composizione con ante di finitura laterali: alla dimensione finale della cucina, sommare sempre lo spessore delle ante di finitura (ogni anta 1,2 cm)

Composition with side finishing panels: to the final size of the kitchen, always add the thickness of the finishing panels (each panel 12 mm)

NOZIONI UTILI - gole "elle" verticali per colonne

USEFUL INFORMATION - VERTICAL "ELLE" FINGER RAILS FOR COLUMNS

VISTA FRONTALE ZOCCOLO H 13

FRONT VIEW PLINTH H 13

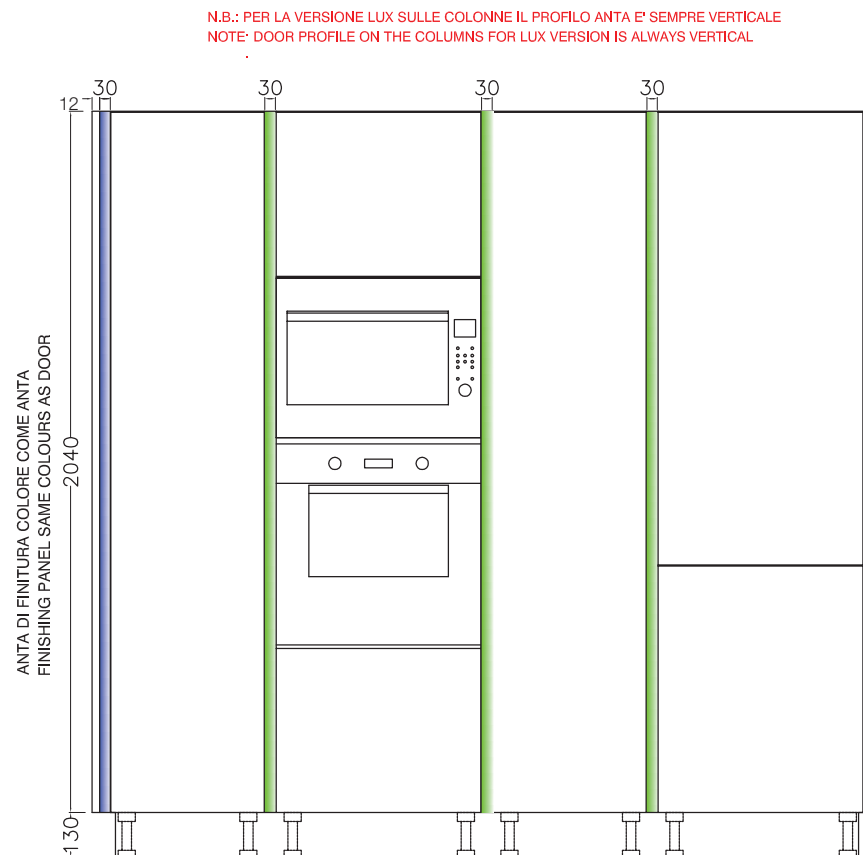

VISTA FRONTALE ZOCCOLO H 6

FRONT VIEW PLINTH H 6

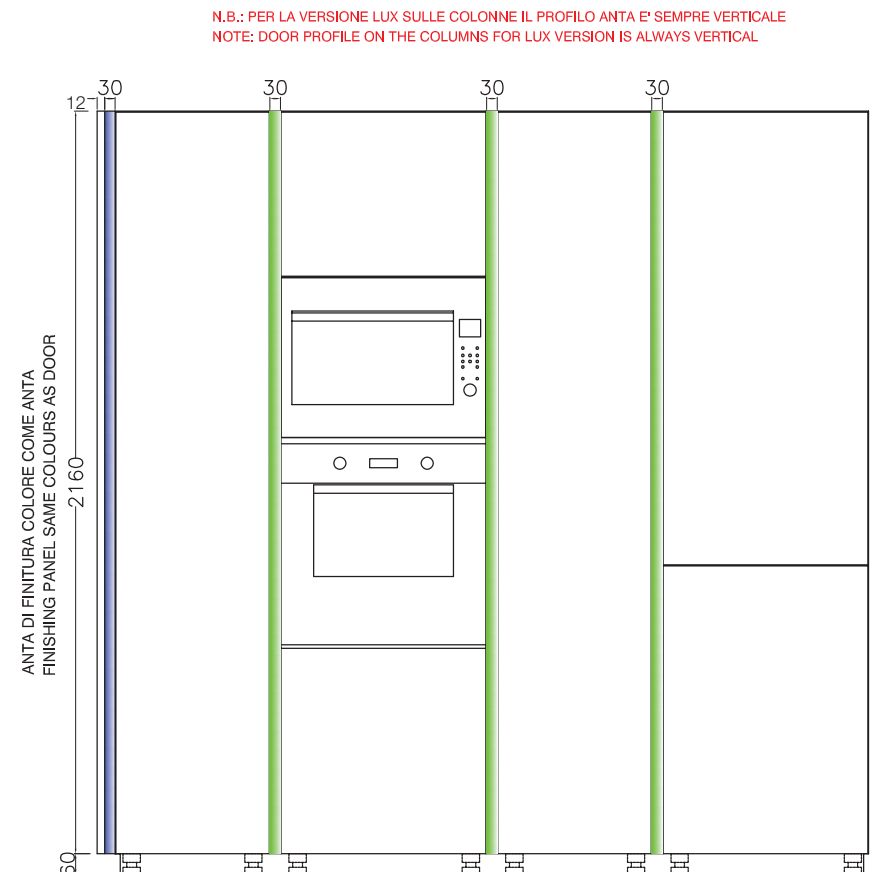

VISTA DALL'ALTO

TOP VIEW

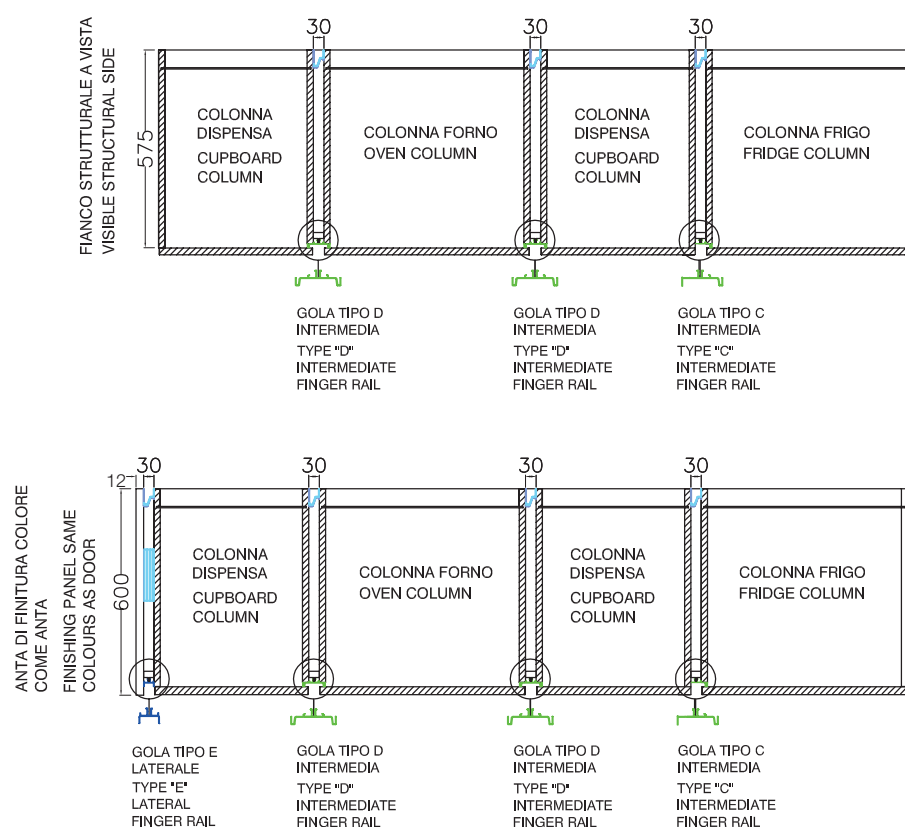

Composizione fianco strutturale
a vista come anta:
alla dimensione finale della cucina,
sommare sempre lo spessore dei
distanziali tra le colonne
(ogni distanziale 3 cm)

Composition with visible side panel to match door:
to the final size of the kitchen, always add the thickness
of the spacers between the two columns (each spacer 3 cm)

Composizione con ante di finitura
laterali, alla dimensione finale della
cucina, sommare sempre lo spessore
dei distanziali tra le colonne
(ogni distanziale 3 cm) e lo spessore
delle ante di finitura (ogni anta 1,2 cm)

Composition with side finishing panels to the final size of the
kitchen, always add the thickness of the spacer between the
two columns (each spacer 3 cm) and the thickness of the
finishing panels (each panel 12 mm)

Anta con maniglia

Door with handle



---• **FRONTALE**
anta con
maniglia
frontale
door with front
handle

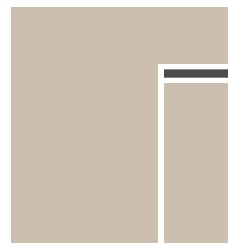

---• **IN TESTA**
anta con
maniglia in testa
door with top
mounted handle



---• **INCASSATA**
anta con maniglia
incassata
door with built-in
handle

TH. 22 MM

TECHNICAL FEATURES

DOORS AND DRAWER FRONTS

22 mm-thick door with panel in certified MDF (compliant with **US EPA TSCA TITLE VI**) coated with polymeric sheet **PET*** textured wood effect vertical grain, post-formed on four sides with melamine interior, in these colours:
white larch with white rear (opt.2414N), lava grey larch with clay rear (opt.2417N), shell larch with shell rear (opt.2415N), mink larch with mink rear (opt.2416N), black larch with blackboard rear (opt.2418N)

22 mm-thick door with panel in certified MDF (compliant with **US EPA TSCA TITLE VI**) coated with polymeric sheet **PET*** wood effect vertical grain, post-formed on four sides with melamine interior, in these colours:
sand elm with mink rear (opt.5077), tobacco elm with mud rear (opt.5078), dark elm with mud rear (opt.5079), oil elm with blackboard rear (opt.5080)

22 mm-thick door with panel in certified MDF (compliant with **US EPA TSCA TITLE VI**) coated with polymeric sheet **PET*** matt solid colour, post-formed on four sides with melamine interior, in these colours:
optical white with white rear (opt.7465), fossena grey with clay rear (opt.9616), soft sand with shell rear (opt.7718), deer with mink rear (opt.9455), brown earth with mud rear (opt.8845), lakis grey with blackboard rear (opt.9618), sedona red with mink rear (opt.8132), beryl green with mink rear (opt.8422), veiled grey with white rear (opt.9600), blu dusty with clay rear (opt.8324)

22 mm-thick door with panel in certified MDF (compliant with **US EPA TSCA TITLE VI**) coated with polymeric sheet **PET*** textured mortar effect, post-formed on four sides with melamine interior, in these colours:
absolute white with white rear (opt.PM01N), lava grey with clay rear (opt.PM04), sand with shell rear (opt.PM02N), mink with mink rear (opt.PM03), grey asphalt with blackboard rear (opt.PM05)

*** polyethylene terephthalate, abbreviated as PET, is a modern synthetic material, environmentally friendly and 100% recyclable. The main features that distinguish it from traditional plastics are its flexibility and excellent dimensional stability, which renders it unalterable over time. Its high resistance to heat, wear and thermal ageing makes PET one of the most innovative, future-oriented materials.**

HANDLES

see page 28-31

CARCASSES

DOORS: lava grey larch with clay rear, lava grey mortar with clay rear, matt fossena grey with clay rear, matt blu dusty with clay rear
standard: melamine-coated clay (opt.9690) clay back panel and shelf (opt.9690)

DOORS: shell larch with shell rear, sand mortar with shell rear, matt soft sand with shell rear
standard: melamine-coated shell (opt.8910) shell back panel and shelf (opt.8910)

DOORS: white larch with white rear, absolute white mortar with white rear, matt optical white with white rear, matt veiled grey with white rear
standard: melamine-coated white (opt.001), white back panel and shelf (opt.001)

DOORS: mink larch with mink rear, mink mortar with mink rear, matt deer with mink rear, sand elm with mink rear, matt sedona red with mink rear, matt beryl green with mink rear
standard: melamine-coated mink (opt.948M) mink back panel and shelf (opt.948M)

DOORS: black ash with blackboard rear, grey asphalt mortar with blackboard rear, oil elm with blackboard rear, matt lakis grey with blackboard rear
standard: melamine-coated slate grey (opt.9620) slate grey back panel and shelf (opt.9620)

DOORS: tobacco elm with mud rear, dark elm with mud rear, matt brown earth with mud rear
standard: melamine-coated mud (opt.8860) mud back panel and shelf (opt.8860)

SHELVES

see page 54

PLINTHS

see page 55



SP. 22 MM TH. 22 MM

ante effetto legno materico post-formate 4 lati
doors with textured wood effect post-formed on 4 sides

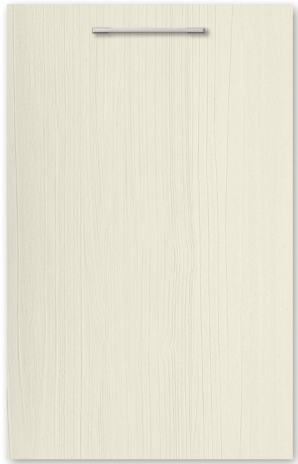

larice bianco
retro bianco (opz.2414N)
white larch with white rear



larice grigio lava
retro argilla (opz.2417N)
lava grey larch with clay rear
N.B.: disponibile a partire da Novembre 2022
Note: available from November 2022



larice conchiglia
retro conchiglia (opz.2415N)
shell larch with shell rear
N.B.: disponibile a partire da Novembre 2022
Note: available from November 2022



larice visone
retro visone (opz.2416N)
mink larch with mink rear
N.B.: disponibile a partire da Novembre 2022
Note: available from November 2022



larice nero
retro lavagna (opz.2418N)
black larch with blackboard rear

ante effetto legno post-formate 4 lati
doors with wood effect post-formed on 4 sides



olmo sabbia
retro visone (opz.5077)
sand elm with mink rear



olmo tabacco
retro fango (opz.5078)
tobacco elm with mud rear



olmo scuro
retro fango (opz.5079)
dark elm with mud rear



olmo petrolio
retro lavagna (opz.5080)
oil elm with blackboard rear



particolare
con maniglia
detailed
with handle

SP. 22 MM TH. 22 MM

ante tinta unita opache post-formate 4 lati
doors with solid matt colour post-formed 4 sides



bianco ottico
retro bianco (opz.7465)
optical white with white rear

grigio fossena
retro argilla (opz.9616)
fossena grey with clay rear

sabbia tenue
retro conchiglia (opz.7718)
soft sand with shell rear

daino
retro visone (opz.9455)
deer with mink rear

terra bruna
retro fango (opz.8845)
brown earth with mud rear

grigio lakis
retro lavagna (opz.9618)
lakis grey with blackboard rear



rosso sedona
retro visone (opz.8132)
sedona red with mink rear

verde berillo
retro visone (opz.8422)
beryl green with mink rear

grigio velato
retro bianco (opz.9600)
veiled grey with white rear

blu dusty
retro argilla (opz.8324)
blu dusty with clay rear

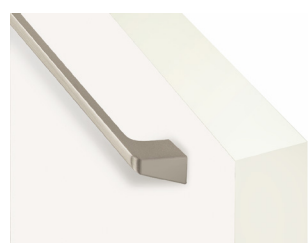

particolare
con maniglia
detailed
with handle

SP. 22 MM TH. 22 MM

ante effetto malta materico post-formate 4 lati
doors with textured mortar effect post-formed 4 sides



malta bianco assoluto
retro bianco (opz.PM01N)
absolute white mortar with
white rear



malta grigio lava
retro argilla (opz.PM04)
lava grey mortar with
clay rear



malta sabbia
retro conchiglia (opz.PM02N)
sand mortar with shell rear



malta visone
retro visone (opz.PM03)
mink mortar with mink rear



malta grigio asfalto
retro lavagna (opz.PM05)
grey asphalt mortar with
blackboard rear



particolare
con maniglia
detailed
with handle

DI SERIE STANDARD



Maniglia 577N finitura nichel satinato
 anta L 15 → passo 64 mm
 anta da L 30 a L 45 → passo 160 mm
 anta da L 60 a L 120 → passo 320 mm

Handle 577N satin nickel finish
 door W 15 → centre-to-centre distance 64 mm
 door from W 30 to W 45 → centre-to-centre distance 160 mm
 door from W 60 to W 120 → centre-to-centre distance 320 mm

A RICHIESTA ON REQUEST

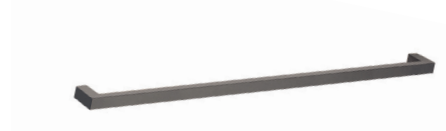

Maniglia 60S finitura silver dark
 anta L 15 → passo 96 mm
 anta da L 30 a L 45 → passo 160 mm
 anta da L 60 a L 120 → passo 320 mm

Handle 60S dark silver finish
 door W 15 → centre-to-centre distance 96 mm
 door from W 30 to W 45 → centre-to-centre distance 160 mm
 door from W 60 to W 120 → centre-to-centre distance 320 mm



Maniglia 60V finitura visone
 anta L 15 → passo 96 mm
 anta da L 30 a L 45 → passo 160 mm
 anta da L 60 a L 120 → passo 320 mm

Handle 60V mink finish
 door W 15 → centre-to-centre distance 96 mm
 door from W 30 to W 45 → centre-to-centre distance 160 mm
 door from W 60 to W 120 → centre-to-centre distance 320 mm



Maniglia 567A finitura soft verniciata antracite
 anta L 15 → passo 64 mm
 anta da L 30 a L 45 → passo 160 mm
 anta da L 60 a L 120 → passo 320 mm

Handle 567A coated soft anthracite finish
 door W 15 → centre-to-centre distance 64 mm
 door from W 30 to W 45 → centre-to-centre distance 160 mm
 door from W 60 to W 120 → centre-to-centre distance 320 mm



Maniglia 567 finitura nichel satinato
 anta L 15 → passo 64 mm
 anta da L 30 a L 45 → passo 160 mm
 anta da L 60 a L 120 → passo 320 mm

Handle 567 satin nickel finish
 door W 15 → centre-to-centre distance 64 mm
 door from W 30 to W 45 → centre-to-centre distance 160 mm
 door from W 60 to W 120 → centre-to-centre distance 320 mm



Maniglia 475S finitura nichel satinato
 anta L 15 → passo 96 mm
 anta da L 30 a L 45 → passo 160 mm
 anta da L 60 a L 120 → passo 320 mm

Handle 475S satin nickel finish
 door W 15 → centre-to-centre distance 96 mm
 door from W 30 to W 45 → centre-to-centre distance 160 mm
 door from W 60 to W 120 → centre-to-centre distance 320 mm

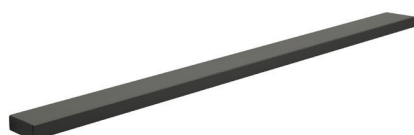

Maniglia 59S finitura silver dark
 anta L 15 → passo 32 mm
 anta L 30 a L 45 → passo 160 mm
 anta da L 60 a L 120 → passo 448 mm

Handle 59S dark silver finish
 door W 15 → centre-to-centre distance 32 mm
 door W 30 to W 45 → centre-to-centre distance 160 mm
 door from W 60 to W 120 → centre-to-centre distance 448 mm

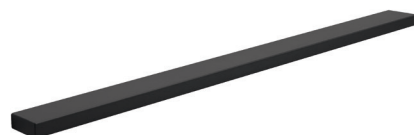

Maniglia 59G finitura ghisa
 anta L 15 → passo 32 mm
 anta L 30 a L 45 → passo 160 mm
 anta da L 60 a L 120 → passo 448 mm

Handle 59G cast iron finish
 door W 15 → centre-to-centre distance 32 mm
 door W 30 to W 45 → centre-to-centre distance 160 mm
 door from W 60 to W 120 → centre-to-centre distance 448 mm

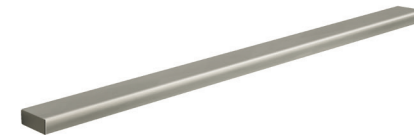

Maniglia 59A finitura acciaio anodizzato
 anta L 15 → passo 32 mm
 anta L 30 a L 45 → passo 160 mm
 anta da L 60 a L 120 → passo 448 mm

Handle 59A anodized steel finish
 door W 15 → centre-to-centre distance 32 mm
 door W 30 to W 45 → centre-to-centre distance 160 mm
 door from W 60 to W 120 → centre-to-centre distance 448 mm

MANIGLIA VERTICALE M42V

M42V HANDLE VERTICAL

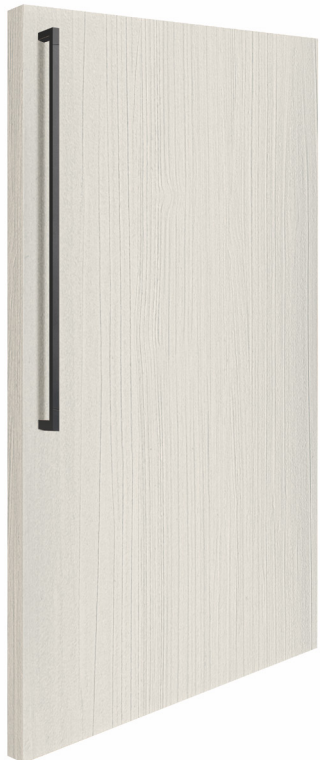

Maniglia M42V finitura nichel satinata
 passo in funzione dell'anta
 Handle M42V nickel satin finish
 centre-to-centre distance varies according to the door

N.B.: la maniglia verticale non è disponibile per tutti gli elementi. Non inseribile su pensili, basi con cassetti e cestone
 Note: The vertical handle is not compatible with all the elements. Is not possible to insert it on the wall units and base units with drawers and deep drawers.

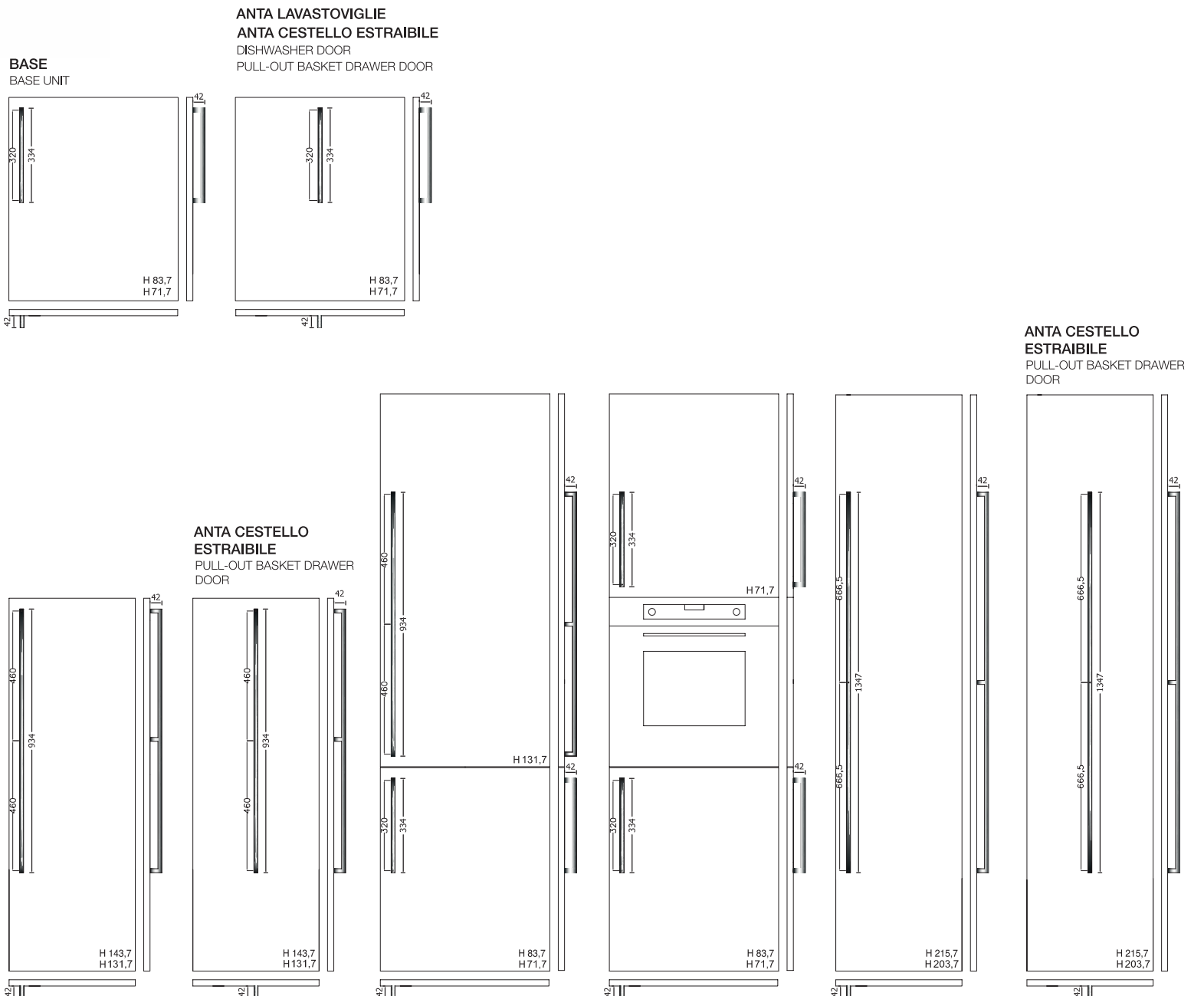

A RICHIESTA ON REQUEST



Maniglia 948S finitura silver dark
 anta L 15 → passo 64 mm
 anta da L 30 a L 45 → passo 160 mm
 anta da L 60 a L 120 → passo 320 mm



Maniglia 948G finitura ghisa
 anta L 15 → passo 64 mm
 anta da L 30 a L 45 → passo 160 mm
 anta da L 60 a L 120 → passo 320 mm



Maniglia 948T finitura titanio
 anta L 15 → passo 64 mm
 anta da L 30 a L 45 → passo 160 mm
 anta da L 60 a L 120 → passo 320 mm

Handle 948S dark silver finish
 door W 15 → centre-to-centre distance 64 mm
 door from W 30 to W 45 → centre-to-centre distance 160 mm
 door from W 60 to W 120 → centre-to-centre distance 320 mm

Handle 948G cast iron finish
 door W 15 → centre-to-centre distance 64 mm
 door from W 30 to W 45 → centre-to-centre distance 160 mm
 door from W 60 to W 120 → centre-to-centre distance 320 mm

Handle 948T titanium finish
 door W 15 → centre-to-centre distance 64 mm
 door from W 30 to W 45 → centre-to-centre distance 160 mm
 door from W 60 to W 120 → centre-to-centre distance 320 mm



Anta Pensile
Wall unit door



Anta Base
Base unit door



Anta Colonna
Column door

Angolo pensile a libro
Corner wall unit folding

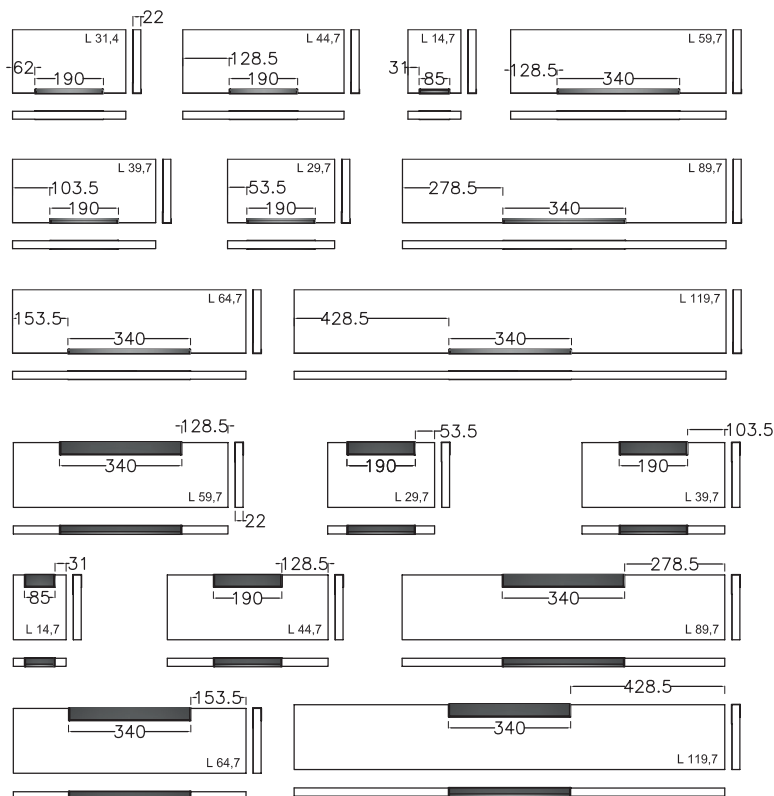

MANIGLIE HANDLES

N.B.: In presenza di questa maniglia non si possono tassativamente realizzare fuori misura in larghezza.
 Note: Custom-sized length elements cannot be realized using this handle.



Maniglia H53 finitura silver dark

Handle H53 dark silver finish



Maniglia H52 finitura titanio

Handle H52 titanium finish

MANIGLIA APPLICATA IN TESTA TOP-MOUNTED HANDLE

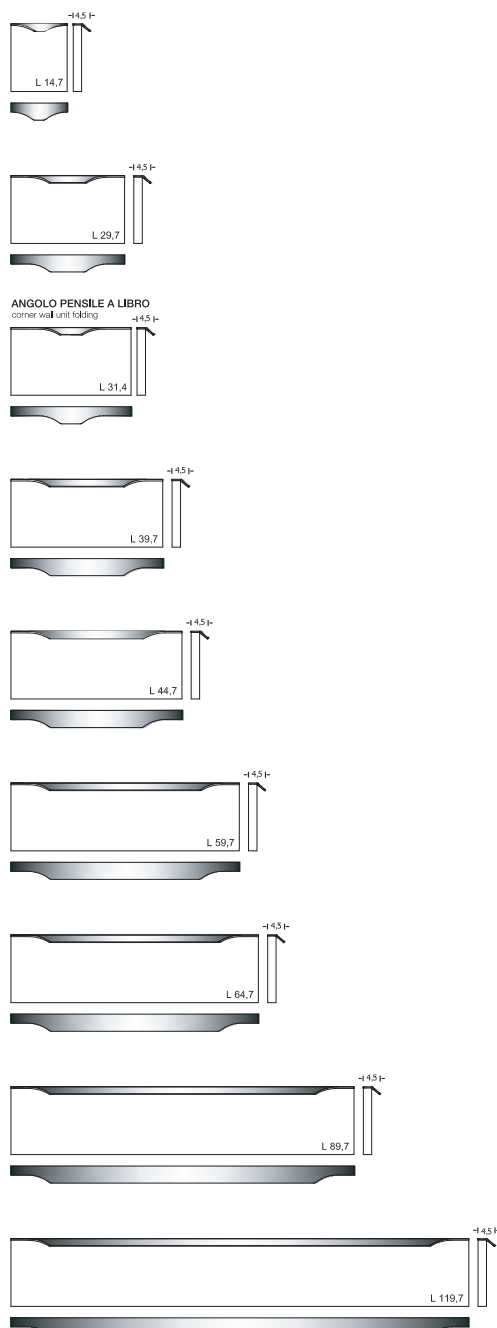

MANIGLIA FRONTALE PER ANTA COLONNA FRONT DOOR HANDLE FOR COLUMN

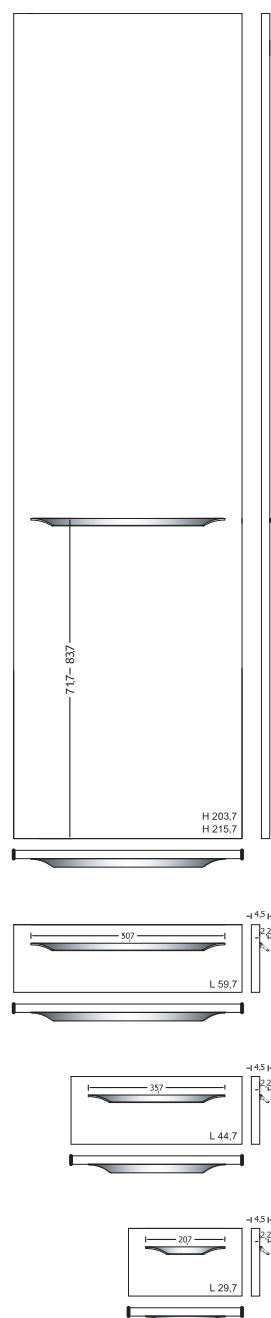



SP. 22 MM

CARATTERISTICHE TECNICHE

ANTE E FRONTALI CASSETTI

anta sp.22 mm con pannello in mdf certificato (conforme **US EPA TSCA TITLE VI**) rivestita in foglia polimerica **PET*** effetto legno materico fiamma verticale, post-formata quattro lati con interno in melaminico, nei colori: larice bianco retro bianco (opz.2414N), larice grigio lava retro argilla (opz.2417N), larice conchiglia retro conchiglia (opz.2415N), larice visone retro visone (opz.2416N), larice nero retro lavagna (opz.2418N)

anta sp.22 mm con pannello in mdf certificato (conforme **US EPA TSCA TITLE VI**) rivestita in foglia polimerica **PET*** effetto legno fiamma verticale, post-formata quattro lati con interno in melaminico, nei colori: olmo sabbia retro visone (opz.5077), olmo tabacco retro fango (opz.5078), olmo scuro retro fango (opz.5079), olmo petrolio retro lavagna (opz.5080)

anta sp.22 mm con pannello in mdf certificato (conforme **US EPA TSCA TITLE VI**) rivestita in foglia polimerica **PET*** colore tinta unita opaco, post-formata quattro lati con interno in melaminico, nei colori: bianco ottico retro bianco (opz.7465), grigio fossena retro argilla (opz.9616), sabbia tenue retro conchiglia (opz.7718), daino retro visone (opz.9455), terra bruna retro fango (opz.8845), grigio lakis retro lavagna (opz.9618), rosso sedona retro visone (opz.8132), verde berillo retro visone (opz.8422), grigio velato retro bianco (opz.9600), blu dusty retro argilla (opz.8324)

anta sp.22 mm con pannello in mdf certificato (conforme **US EPA TSCA TITLE VI**) rivestita in foglia polimerica **PET*** materica effetto malta, post-formata quattro lati con interno in melaminico, nei colori: bianco assoluto retro bianco (opz.PM01N), grigio lava retro argilla (opz.PM04), sabbia retro conchiglia (opz.PM02N), visone retro visone (opz.PM03), grigio asfalto retro lavagna (opz.PM05)

*** il polietilenteraftelato, conosciuto sotto l'abbreviazione PET, è una materia sintetica moderna, ecologica e riciclabile al 100%. Le principali caratteristiche che lo diversificano dalle tradizionali materie plastiche sono la flessibilità e l'eccellente stabilità dimensionale che lo rendono inalterabile nel tempo. L'elevata resistenza al calore, all'usura ed all'invecchiamento termico fanno del PET uno dei materiali più innovativi ed orientati al futuro.**

MANIGLIE

vedi pag.28-31

STRUTTURE

ANTE: larice grigio lava retro argilla, malta grigio lava retro argilla, grigio fossena opaco retro argilla, blu dusty opaco retro argilla di serie : nobilitato argilla (opz.9690) schiena e ripiano argilla (opz.9690)

ANTE: larice conchiglia retro conchiglia, malta sabbia retro conchiglia, sabbia tenue opaco retro conchiglia di serie : nobilitato conchiglia (opz.8910) schiena e ripiano conchiglia (opz.8910)

ANTE: larice bianco retro bianco, malta bianco assoluto retro bianco, bianco ottico opaco retro bianco, grigio velato opaco retro bianco di serie : nobilitato bianco (opz.001) schiena e ripiano bianco (opz.001)

ANTE: larice visone retro visone, malta visone retro visone, daino opaco retro visone, olmo sabbia retro visone, rosso sedona opaco retro visone, verde berillo opaco retro visone di serie : nobilitato visone (opz.948M) schiena e ripiano visone (opz.948M)

ANTE: larice nero retro lavagna, malta grigio asfalto retro lavagna, olmo petrolio retro lavagna, grigio lakis retro lavagna di serie : nobilitato lavagna (opz.9620) schiena e ripiano lavagna (opz.9620)

ANTE: olmo tabacco retro fango, olmo scuro retro fango, terra bruna retro fango di serie : nobilitato fango (opz.8860) schiena e ripiano fango (opz.8860)



GREENGUARD
LE STRUTTURE DELLE CUCINE SONO CONTRADDISTINTE DALLA CERTIFICAZIONE GREENGUARD PER SODDISFARE GLI STANDARD PIU' RIGOROSI IN TERMINI DI LIVELLI DI EMISSIONE DI COMPOSTI ORGANICI VOLATILI (COV).

MENSOLE

vedi pag.54

ZOCCOLI

vedi pag.55



TH. 22 MM

TECHNICAL FEATURES

DOORS AND DRAWER FRONTS

22 mm-thick door with panel in certified MDF (compliant with **US EPA TSCA TITLE VI**) coated with polymeric sheet **PET*** textured wood effect vertical grain, post-formed on four sides with melamine interior, in these colours:
white larch with white rear (opt.2414N), lava grey larch with clay rear (opt.2417N), shell larch with shell rear (opt.2415N), mink larch with mink rear (opt.2416N), black larch with blackboard rear (opt.2418N)

22 mm-thick door with panel in certified MDF (compliant with **US EPA TSCA TITLE VI**) coated with polymeric sheet **PET*** wood effect vertical grain, post-formed on four sides with melamine interior, in these colours:
sand elm with mink rear (opt.5077), tobacco elm with mud rear (opt.5078), dark elm with mud rear (opt.5079), oil elm with blackboard rear (opt.5080)

22 mm-thick door with panel in certified MDF (compliant with **US EPA TSCA TITLE VI**) coated with polymeric sheet **PET*** matt solid colour, post-formed on four sides with melamine interior, in these colours:
optical white with white rear (opt.7465), fossena grey with clay rear (opt.9616), soft sand with shell rear (opt.7718), deer with mink rear (opt.9455), brown earth with mud rear (opt.8845), lakis grey with blackboard rear (opt.9618), sedona red with mink rear (opt.8132), beryl green with mink rear (opt.8422), veiled grey with white rear (opt.9600), blu dusty with clay rear (opt.8324)

22 mm-thick door with panel in certified MDF (compliant with **US EPA TSCA TITLE VI**) coated with polymeric sheet **PET*** textured mortar effect, post-formed on four sides with melamine interior, in these colours:
absolute white with white rear (opt.PM01N), lava grey with clay rear (opt.PM04), sand with shell rear (opt.PM02N), mink with mink rear (opt.PM03), grey asphalt with blackboard rear (opt.PM05)

*** polyethylene terephthalate, abbreviated as PET, is a modern synthetic material, environmentally friendly and 100% recyclable. The main features that distinguish it from traditional plastics are its flexibility and excellent dimensional stability, which renders it unalterable over time. Its high resistance to heat, wear and thermal ageing makes PET one of the most innovative, future-oriented materials.**

HANDLES

see page 28-31

CARCASSES

DOORS: lava grey larch with clay rear, lava grey mortar with clay rear, matt fossena grey with clay rear, matt blu dusty with clay rear
standard: melamine-coated clay (opt.9690) clay back panel and shelf (opt.9690)

DOORS: shell larch with shell rear, sand mortar with shell rear, matt soft sand with shell rear
standard: melamine-coated shell (opt.8910) shell back panel and shelf (opt.8910)

DOORS: white larch with white rear, absolute white mortar with white rear, matt optical white with white rear, matt veiled grey with white rear
standard: melamine-coated white (opt.001), white back panel and shelf (opt.001)

DOORS: mink larch with mink rear, mink mortar with mink rear, matt deer with mink rear, sand elm with mink rear, matt sedona red with mink rear, matt beryl green with mink rear
standard: melamine-coated mink (opt.948M) mink back panel and shelf (opt.948M)

DOORS: black ash with blackboard rear, grey asphalt mortar with blackboard rear, oil elm with blackboard rear, matt lakis grey with blackboard rear
standard: melamine-coated slate grey (opt.9620) slate grey back panel and shelf (opt.9620)

DOORS: tobacco elm with mud rear, dark elm with mud rear, matt brown earth with mud rear
standard: melamine-coated mud (opt.8860) mud back panel and shelf (opt.8860)

SHELVES

see page 54

PLINTHS

see page 55



SP. 22 MM TH. 22 MM

ante effetto legno materico post-formate 4 lati
doors with textured wood effect post-formed on 4 sides

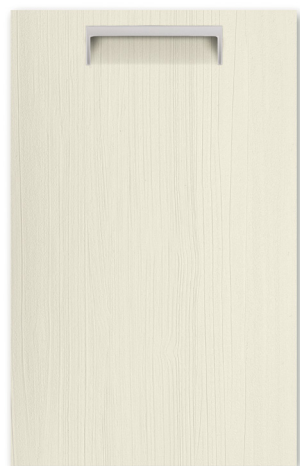

larice bianco
retro bianco (opz.2414N)
white larch with white rear



larice grigio lava
retro argilla (opz.2417N)
lava grey larch with clay rear
N.B.: disponibile a partire da Novembre 2022
Note: available from November 2022



larice conchiglia
retro conchiglia (opz.2415N)
shell larch with shell rear
N.B.: disponibile a partire da Novembre 2022
Note: available from November 2022



larice visone
retro visone (opz.2416N)
mink larch with mink rear
N.B.: disponibile a partire da Novembre 2022
Note: available from November 2022



larice nero
retro lavagna (opz.2418N)
black larch with blackboard rear

ante effetto legno post-formate 4 lati
doors with wood effect post-formed on 4 sides



olmo sabbia
retro visone (opz.5077)
sand elm with mink rear



olmo tabacco
retro fango (opz.5078)
tobacco elm with mud rear



olmo scuro
retro fango (opz.5079)
dark elm with mud rear



olmo petrolio
retro lavagna (opz.5080)
oil elm with blackboard rear



particolare
con maniglia
detailed
with handle

N.B.: per schemi maniglia vedi pag.37
Note: for handle diagrams see page 37

SP. 22 MM TH. 22 MM

ante tinta unita opache post-formate 4 lati
doors with solid matt colour post-formed 4 sides



bianco ottico
retro bianco (opz.7465)
optical white with white rear

grigio fossena
retro argilla (opz.9616)
fossena grey with clay rear

sabbia tenue
retro conchiglia (opz.7718)
soft sand with shell rear

daino
retro visone (opz.9455)
deer with mink rear

terra bruna
retro fango (opz.8845)
brown earth with mud rear

grigio lakis
retro lavagna (opz.9618)
lakis grey with blackboard rear

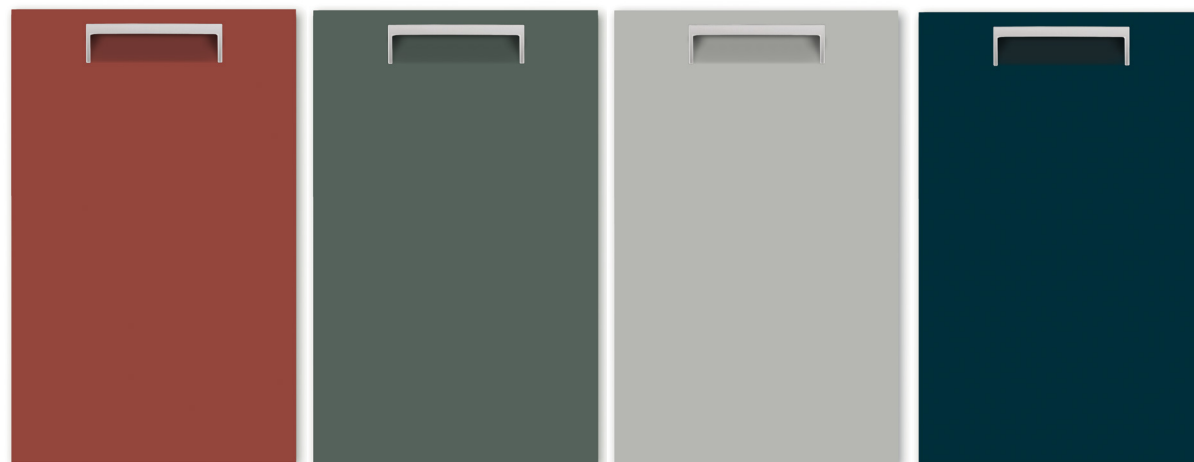

rosso sedona
retro visone (opz.8132)
sedona red with mink rear

verde berillo
retro visone (opz.8422)
beryl green with mink rear

grigio velato
retro bianco (opz.9600)
veiled grey with white rear

blu dusty
retro argilla (opz.8324)
blu dusty with clay rear

ante effetto malta materico post-formate 4 lati
doors with textured mortar effect post-formed 4 sides

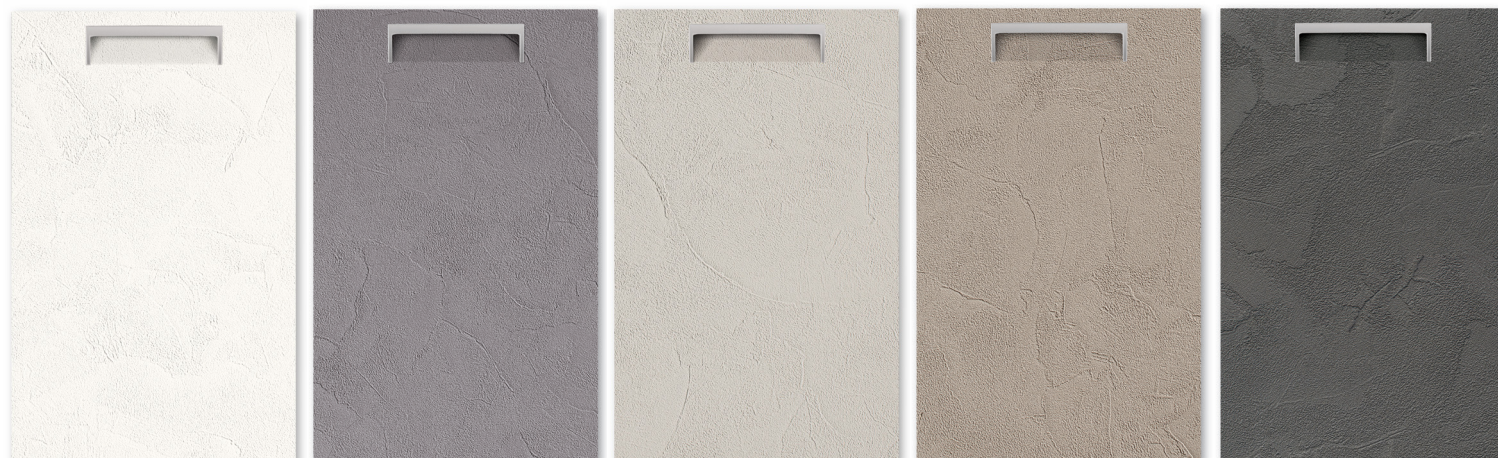

malta bianco assoluto
retro bianco (opz.PM01N)
absolute white mortar with white rear

malta grigio lava
retro argilla (opz.PM04)
lava grey mortar with clay rear

malta sabbia
retro conchiglia (opz.PM02N)
sand mortar with shell rear

malta visone
retro visone (opz.PM03)
mink mortar with mink rear

malta grigio asfalto
retro lavagna (opz.PM05)
grey asphalt mortar with blackboard rear

ROUND AREA MANIGLIE ROUND AREA HANDLES



Maniglia 963G finitura ghisa
 anta L 15 → passo 96 mm
 anta da L 30 a L 120 → passo 192 mm

Handle 963G cast iron finish
 door W 15 → centre-to-centre distance 96 mm
 door from W 30 to W 120 → centre-to-centre distance 192 mm



Maniglia 963S finitura silver dark
 anta L 15 → passo 96 mm
 anta da L 30 a L 120 → passo 192 mm

Handle 963S dark silver finish
 door W 15 → centre-to-centre distance 96 mm
 door from W 30 to W 120 → centre-to-centre distance 192 mm



Maniglia 963N finitura nichel satinato
 anta L 15 → passo 96 mm
 anta da L 30 a L 120 → passo 192 mm

Handle 963N satin nickel finish
 door W 15 → centre-to-centre distance 96 mm
 door from W 30 to W 120 → centre-to-centre distance 192 mm

Angolo pensile a libro Corner wall unit folding

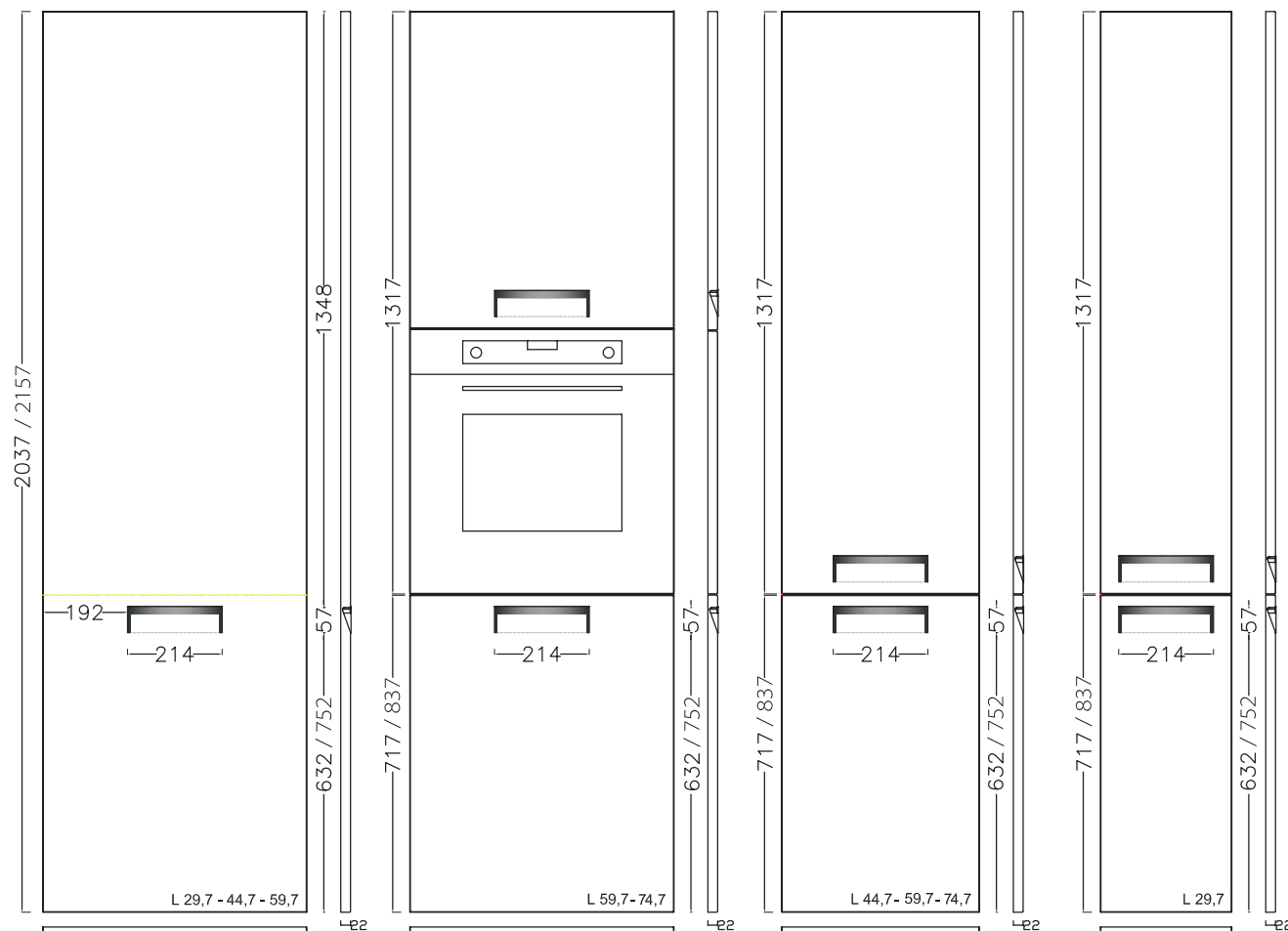
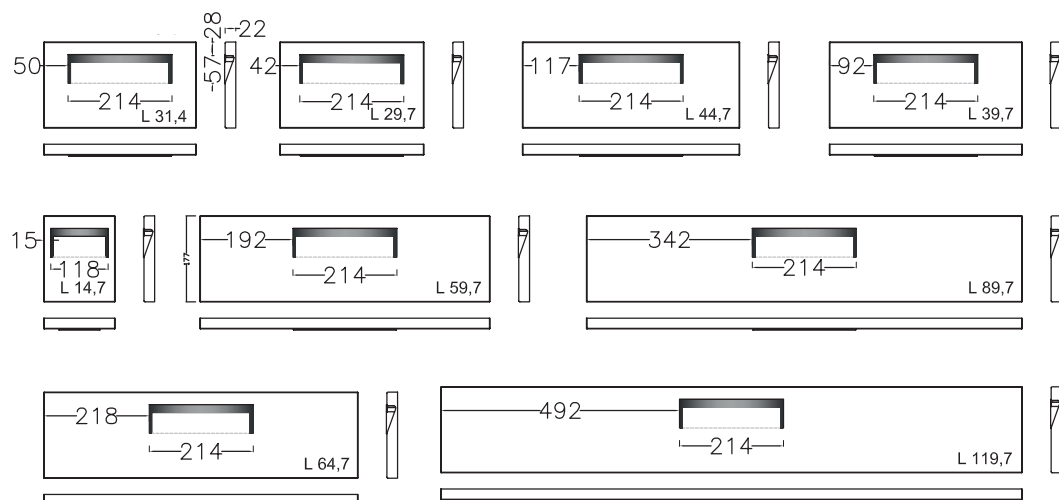



SP. 22 MM

CARATTERISTICHE TECNICHE

ANTE E FRONTALI CASSETTI

anta sp.22 mm con pannello in mdf certificato (conforme **US EPA TSCA TITLE VI**) rivestita in foglia polimerica **PET*** effetto legno materico fiamma verticale, post-formata quattro lati con interno in melaminico, nei colori: larice bianco retro bianco (opz.2414N), larice grigio lava retro argilla (opz.2417N), larice conchiglia retro conchiglia (opz.2415N), larice visone retro visone (opz.2416N), larice nero retro lavagna (opz.2418N)

anta sp.22 mm con pannello in mdf certificato (conforme **US EPA TSCA TITLE VI**) rivestita in foglia polimerica **PET*** effetto legno fiamma verticale, post-formata quattro lati con interno in melaminico, nei colori: olmo sabbia retro visone (opz.5077), olmo tabacco retro fango (opz.5078), olmo scuro retro fango (opz.5079), olmo petrolio retro lavagna (opz.5080)

anta sp.22 mm con pannello in mdf certificato (conforme **US EPA TSCA TITLE VI**) rivestita in foglia polimerica **PET*** colore tinta unita opaco, post-formata quattro lati con interno in melaminico, nei colori: bianco ottico retro bianco (opz.7465), grigio fossena retro argilla (opz.9616), sabbia tenue retro conchiglia (opz.7718), daino retro visone (opz.9455), terra bruna retro fango (opz.8845), grigio lakis retro lavagna (opz.9618), rosso sedona retro visone (opz.8132), verde berillo retro visone (opz.8422), grigio velato retro bianco (opz.9600), blu dusty retro argilla (opz.8324)

anta sp.22 mm con pannello in mdf certificato (conforme **US EPA TSCA TITLE VI**) rivestita in foglia polimerica **PET*** materica effetto malta, post-formata quattro lati con interno in melaminico, nei colori: bianco assoluto retro bianco (opz.PM01N), grigio lava retro argilla (opz.PM04), sabbia retro conchiglia (opz.PM02N), visone retro visone (opz.PM03), grigio asfalto retro lavagna (opz.PM05)

*** il polietilenteraftelato, conosciuto sotto l'abbreviazione PET, è una materia sintetica moderna, ecologica e riciclabile al 100%. Le principali caratteristiche che lo diversificano dalle tradizionali materie plastiche sono la flessibilità e l'eccellente stabilità dimensionale che lo rendono inalterabile nel tempo. L'elevata resistenza al calore, all'usura ed all'invecchiamento termico fanno del PET uno dei materiali più innovativi ed orientati al futuro.**

MANIGLIE

vedi pag.28-31

STRUTTURE

ANTE: larice grigio lava retro argilla, malta grigio lava retro argilla, grigio fossena opaco retro argilla, blu dusty opaco retro argilla di serie : nobilitato argilla (opz.9690) schiena e ripiano argilla (opz.9690)

ANTE: larice conchiglia retro conchiglia, malta sabbia retro conchiglia, sabbia tenue opaco retro conchiglia di serie : nobilitato conchiglia (opz.8910) schiena e ripiano conchiglia (opz.8910)

ANTE: larice bianco retro bianco, malta bianco assoluto retro bianco, bianco ottico opaco retro bianco, grigio velato opaco retro bianco di serie : nobilitato bianco (opz.001) schiena e ripiano bianco (opz.001)

ANTE: larice visone retro visone, malta visone retro visone, daino opaco retro visone, olmo sabbia retro visone, rosso sedona opaco retro visone, verde berillo opaco retro visone di serie : nobilitato visone (opz.948M) schiena e ripiano visone (opz.948M)

ANTE: larice nero retro lavagna, malta grigio asfalto retro lavagna, olmo petrolio retro lavagna, grigio lakis retro lavagna di serie : nobilitato lavagna (opz.9620) schiena e ripiano lavagna (opz.9620)

ANTE: olmo tabacco retro fango, olmo scuro retro fango, terra bruna retro fango di serie : nobilitato fango (opz.8860) schiena e ripiano fango (opz.8860)



*per componenti si intendono tutte le strutture, alcune ante e alcuni complementi del modello.



GREENGUARD
LE STRUTTURE DELLE CUCINE SONO CONTRADDISTINTE DALLA CERTIFICAZIONE GREENGUARD PER SODDISFARE GLI STANDARD PIU' RIGOROSI IN TERMINI DI LIVELLI DI EMISSIONE DI COMPOSTI ORGANICI VOLATILI (COV).

MENSOLE

vedi pag.54

ZOCCOLI

vedi pag.55



TH. 22 MM

TECHNICAL FEATURES

DOORS AND DRAWER FRONTS

22 mm-thick door with panel in certified MDF (compliant with **US EPA TSCA TITLE VI**) coated with polymeric sheet **PET*** textured wood effect vertical grain, post-formed on four sides with melamine interior, in these colours:
white larch with white rear (opt.2414N), lava grey larch with clay rear (opt.2417N), shell larch with shell rear (opt.2415N), mink larch with mink rear (opt.2416N), black larch with blackboard rear (opt.2418N)

22 mm-thick door with panel in certified MDF (compliant with **US EPA TSCA TITLE VI**) coated with polymeric sheet **PET*** wood effect vertical grain, post-formed on four sides with melamine interior, in these colours:
sand elm with mink rear (opt.5077), tobacco elm with mud rear (opt.5078), dark elm with mud rear (opt.5079), oil elm with blackboard rear (opt.5080)

22 mm-thick door with panel in certified MDF (compliant with **US EPA TSCA TITLE VI**) coated with polymeric sheet **PET*** matt solid colour, post-formed on four sides with melamine interior, in these colours:
optical white with white rear (opt.7465), fossena grey with clay rear (opt.9616), soft sand with shell rear (opt.7718), deer with mink rear (opt.9455), brown earth with mud rear (opt.8845), lakis grey with blackboard rear (opt.9618), sedona red with mink rear (opt.8132), beryl green with mink rear (opt.8422), veiled grey with white rear (opt.9600), blu dusty with clay rear (opt.8324)

22 mm-thick door with panel in certified MDF (compliant with **US EPA TSCA TITLE VI**) coated with polymeric sheet **PET*** textured mortar effect, post-formed on four sides with melamine interior, in these colours:
absolute white with white rear (opt.PM01N), lava grey with clay rear (opt.PM04), sand with shell rear (opt.PM02N), mink with mink rear (opt.PM03), grey asphalt with blackboard rear (opt.PM05)

*** polyethylene terephthalate, abbreviated as PET, is a modern synthetic material, environmentally friendly and 100% recyclable. The main features that distinguish it from traditional plastics are its flexibility and excellent dimensional stability, which renders it unalterable over time. Its high resistance to heat, wear and thermal ageing makes PET one of the most innovative, future-oriented materials.**

HANDLES

see page 28-31

CARCASSES

DOORS: lava grey larch with clay rear, lava grey mortar with clay rear, matt fossena grey with clay rear, matt blu dusty with clay rear
standard: melamine-coated clay (opt.9690) clay back panel and shelf (opt.9690)

DOORS: shell larch with shell rear, sand mortar with shell rear, matt soft sand with shell rear
standard: melamine-coated shell (opt.8910) shell back panel and shelf (opt.8910)

DOORS: white larch with white rear, absolute white mortar with white rear, matt optical white with white rear, matt veiled grey with white rear
standard: melamine-coated white (opt.001), white back panel and shelf (opt.001)

DOORS: mink larch with mink rear, mink mortar with mink rear, matt deer with mink rear, sand elm with mink rear, matt sedona red with mink rear, matt beryl green with mink rear
standard: melamine-coated mink (opt.948M) mink back panel and shelf (opt.948M)

DOORS: black ash with blackboard rear, grey asphalt mortar with blackboard rear, oil elm with blackboard rear, matt lakis grey with blackboard rear
standard: melamine-coated slate grey (opt.9620) slate grey back panel and shelf (opt.9620)

DOORS: tobacco elm with mud rear, dark elm with mud rear, matt brown earth with mud rear
standard: melamine-coated mud (opt.8860) mud back panel and shelf (opt.8860)

SHELVES

see page 54

PLINTHS

see page 55



SP. 22 MM TH. 22 MM

ante effetto legno materico post-formate 4 lati
doors with textured wood effect post-formed on 4 sides

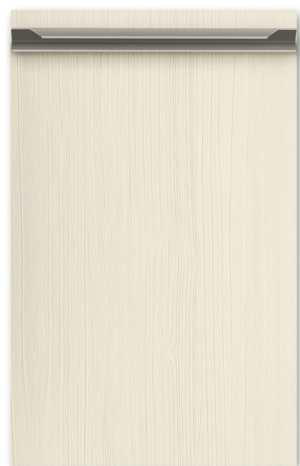

larice bianco
retro bianco (opz.2414N)
white larch with white rear



larice grigio lava
retro argilla (opz.2417N)
lava grey larch with clay rear
N.B.: disponibile a partire da Novembre 2022
Note: available from November 2022



larice conchiglia
retro conchiglia (opz.2415N)
shell larch with shell rear
N.B.: disponibile a partire da Novembre 2022
Note: available from November 2022



larice visone
retro visone (opz.2416N)
mink larch with mink rear
N.B.: disponibile a partire da Novembre 2022
Note: available from November 2022



larice nero
retro lavagna (opz.2418N)
black larch with blackboard rear

ante effetto legno post-formate 4 lati
doors with wood effect post-formed on 4 sides



olmo sabbia
retro visone (opz.5077)
sand elm with mink rear



olmo tabacco
retro fango (opz.5078)
tobacco elm with mud rear



olmo scuro
retro fango (opz.5079)
dark elm with mud rear



olmo petrolio
retro lavagna (opz.5080)
oil elm with blackboard rear



particolare
con maniglia
detailed
with handle

N.B.: per schemi maniglia vedi pag.44-45
Note: for handle diagrams see page 44-45



ROUND BOX MANIGLIA INCASSATA ORIZZONTALE

ROUND BOX HANDLE BUILT-IN HORIZONTAL



Maniglia 906G finitura ghisa
presa maniglia incassata
(vedi schema tecnico)

Handle 906G cast iron finish
built-in handle socket
(size see technical diagram)



Maniglia 906S finitura silver dark
presa maniglia incassata
(vedi schema tecnico)

Handle 906S dark silver finish
built-in handle socket
(size see technical diagram)



Maniglia 906F finitura grigio selce
presa maniglia incassata
(vedi schema tecnico)

Handle 906F flint grey finish
built-in handle socket
(size see technical diagram)



Maniglia 906B finitura nero
presa maniglia incassata
(vedi schema tecnico)

Handle 906B black finish
built-in handle socket
(size see technical diagram)

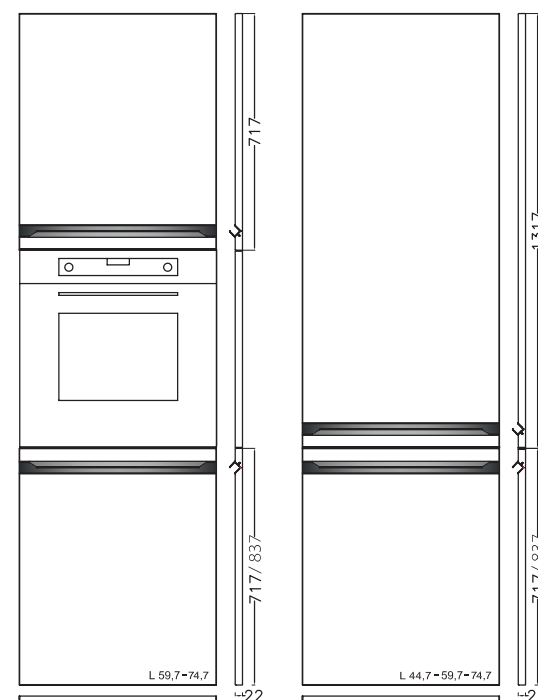
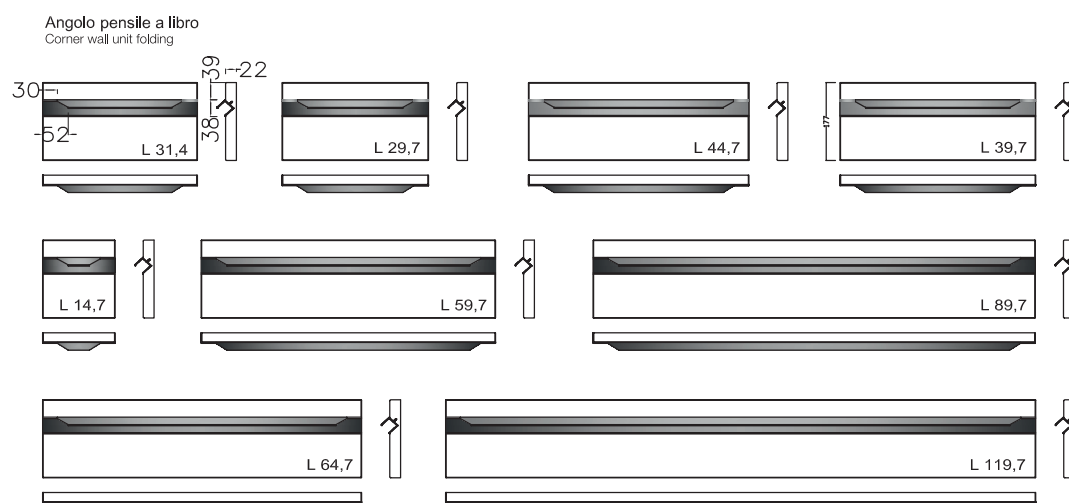

ROUND BOX MANIGLIA INCASSATA VERTICALE

ROUND BOX HANDLE BUILT-IN VERTICAL

N.B.: disponibile solo per alcuni elementi

Note: available on few elements only



Maniglia 906GV finitura ghisa
presa maniglia incassata
(vedi schema tecnico)

Handle 906GV cast iron finish
built-in handle socket
(size see technical diagram)



Maniglia 906SV finitura silver dark
presa maniglia incassata
(vedi schema tecnico)

Handle 906SV dark silver finish
built-in handle socket
(size see technical diagram)



Maniglia 906FV finitura grigio selce
presa maniglia incassata
(vedi schema tecnico)

Handle 906FV flint grey finish
built-in handle socket
(size see technical diagram)



Maniglia 906BV finitura nero
presa maniglia incassata
(vedi schema tecnico)

Handle 906BV black finish
built-in handle socket
(size see technical diagram)

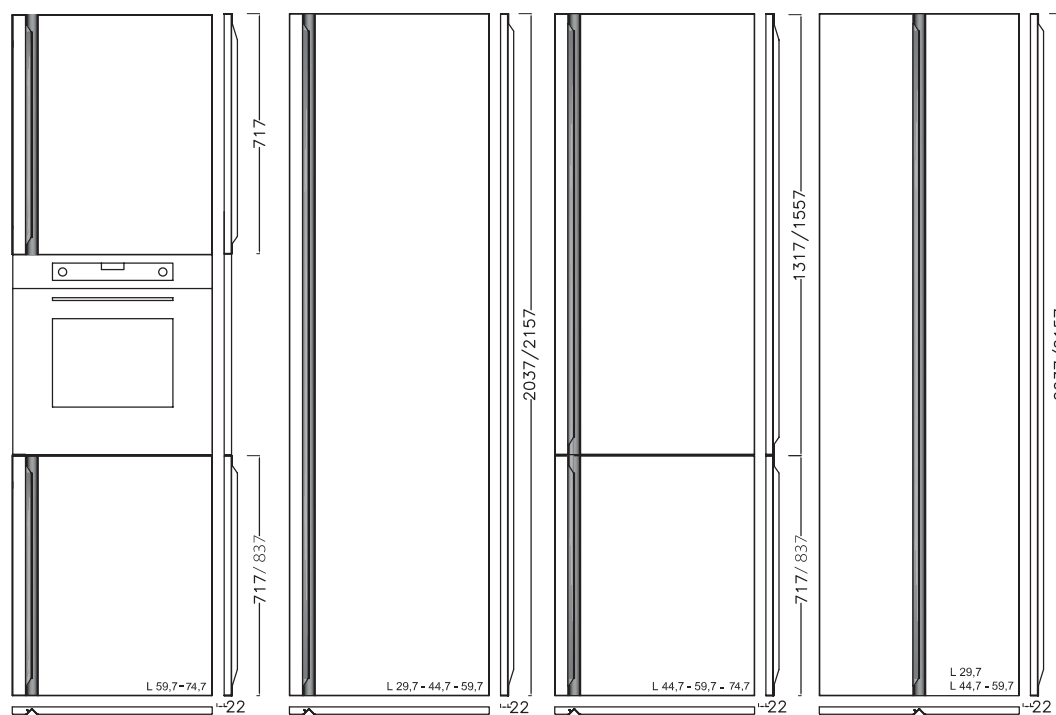



SP. 22 MM

CARATTERISTICHE TECNICHE

ANTE E FRONTALI CASSETTI

anta sp.22 mm con pannello in mdf certificato (conforme **US EPA TSCA TITLE VI**) rivestita in foglia polimerica **PET*** effetto legno materico fiamma verticale, post-formata quattro lati con interno in melaminico, nei colori: larice bianco retro bianco (opz.2414N), larice grigio lava retro argilla (opz.2417N), larice conchiglia retro conchiglia (opz.2415N), larice visone retro visone (opz.2416N), larice nero retro lavagna (opz.2418N)

anta sp.22 mm con pannello in mdf certificato (conforme **US EPA TSCA TITLE VI**) rivestita in foglia polimerica **PET*** effetto legno fiamma verticale, post-formata quattro lati con interno in melaminico, nei colori: olmo sabbia retro visone (opz.5077), olmo tabacco retro fango (opz.5078), olmo scuro retro fango (opz.5079), olmo petrolio retro lavagna (opz.5080)

anta sp.22 mm con pannello in mdf certificato (conforme **US EPA TSCA TITLE VI**) rivestita in foglia polimerica **PET*** colore tinta unita opaco, post-formata quattro lati con interno in melaminico, nei colori: bianco ottico retro bianco (opz.7465), grigio fossena retro argilla (opz.9616), sabbia tenue retro conchiglia (opz.7718), daino retro visone (opz.9455), terra bruna retro fango (opz.8845), grigio lakis retro lavagna (opz.9618), rosso sedona retro visone (opz.8132), verde berillo retro visone (opz.8422), grigio velato retro bianco (opz.9600), blu dusty retro argilla (opz.8324)

anta sp.22 mm con pannello in mdf certificato (conforme **US EPA TSCA TITLE VI**) rivestita in foglia polimerica **PET*** materica effetto malta, post-formata quattro lati con interno in melaminico, nei colori: bianco assoluto retro bianco (opz.PM01N), grigio lava retro argilla (opz.PM04), sabbia retro conchiglia (opz.PM02N), visone retro visone (opz.PM03), grigio asfalto retro lavagna (opz.PM05)

*** il polietilenteraftelato, conosciuto sotto l'abbreviazione PET, è una materia sintetica moderna, ecologica e riciclabile al 100%. Le principali caratteristiche che lo diversificano dalle tradizionali materie plastiche sono la flessibilità e l'eccellente stabilità dimensionale che lo rendono inalterabile nel tempo. L'elevata resistenza al calore, all'usura ed all'invecchiamento termico fanno del PET uno dei materiali più innovativi ed orientati al futuro.**

MANIGLIE

vedi pag.28-31

STRUTTURE

ANTE: larice grigio lava retro argilla, malta grigio lava retro argilla, grigio fossena opaco retro argilla, blu dusty opaco retro argilla di serie : nobilitato argilla (opz.9690) schiena e ripiano argilla (opz.9690),

ANTE: larice conchiglia retro conchiglia, malta sabbia retro conchiglia, sabbia tenue opaco retro conchiglia,

di serie : nobilitato conchiglia (opz.8910) schiena e ripiano conchiglia (opz.8910)

ANTE: larice bianco retro bianco, malta bianco assoluto retro bianco, bianco ottico opaco retro bianco, grigio velato opaco retro bianco

di serie : nobilitato bianco (opz.001) schiena e ripiano bianco (opz.001)

ANTE: larice visone retro visone, malta visone retro visone, daino opaco retro visone, olmo sabbia retro visone, rosso sedona opaco retro visone, verde berillo opaco retro visone di serie : nobilitato visone (opz.948M) schiena e ripiano visone (opz.948M)

ANTE: larice nero retro lavagna, malta grigio asfalto retro lavagna, olmo petrolio retro lavagna, grigio lakis retro lavagna

di serie : nobilitato lavagna (opz.9620) schiena e ripiano lavagna (opz.9620)

ANTE: olmo tabacco retro fango, olmo scuro retro fango, terra bruna retro fango

di serie : nobilitato fango (opz.8860) schiena e ripiano fango (opz.8860)



*per componenti si intendono tutte le strutture, alcune ante e alcuni complementi del modello.



GREENGUARD
LE STRUTTURE DELLE CUCINE SONO CONTRADDISTINTE DALLA CERTIFICAZIONE GREENGUARD PER SODDISFARE GLI STANDARD PIU' RIGOROSI IN TERMINI DI LIVELLI DI EMISSIONE DI COMPOSTI ORGANICI VOLATILI (COV).

MENSOLE

vedi pag.54

ZOCCOLI

vedi pag.55



TH. 22 MM

TECHNICAL FEATURES

DOORS AND DRAWER FRONTS

22 mm-thick door with panel in certified MDF (compliant with **US EPA TSCA TITLE VI**) coated with polymeric sheet **PET*** textured wood effect vertical grain, post-formed on four sides with melamine interior, in these colours:
white larch with white rear (opt.2414N), lava grey larch with clay rear (opt.2417N), shell larch with shell rear (opt.2415N), mink larch with mink rear (opt.2416N), black larch with blackboard rear (opt.2418N)

22 mm-thick door with panel in certified MDF (compliant with **US EPA TSCA TITLE VI**) coated with polymeric sheet **PET*** wood effect vertical grain, post-formed on four sides with melamine interior, in these colours:
sand elm with mink rear (opt.5077), tobacco elm with mud rear (opt.5078), dark elm with mud rear (opt.5079), oil elm with blackboard rear (opt.5080)

22 mm-thick door with panel in certified MDF (compliant with **US EPA TSCA TITLE VI**) coated with polymeric sheet **PET*** matt solid colour, post-formed on four sides with melamine interior, in these colours:
optical white with white rear (opt.7465), fossena grey with clay rear (opt.9616), soft sand with shell rear (opt.7718), deer with mink rear (opt.9455), brown earth with mud rear (opt.8845), lakis grey with blackboard rear (opt.9618), sedona red with mink rear (opt.8132), beryl green with mink rear (opt.8422), veiled grey with white rear (opt.9600), blu dusty with clay rear (opt.8324)

22 mm-thick door with panel in certified MDF (compliant with **US EPA TSCA TITLE VI**) coated with polymeric sheet **PET*** textured mortar effect, post-formed on four sides with melamine interior, in these colours:
absolute white with white rear (opt.PM01N), lava grey with clay rear (opt.PM04), sand with shell rear (opt.PM02N), mink with mink rear (opt.PM03), grey asphalt with blackboard rear (opt.PM05)

*** polyethylene terephthalate, abbreviated as PET, is a modern synthetic material, environmentally friendly and 100% recyclable. The main features that distinguish it from traditional plastics are its flexibility and excellent dimensional stability, which renders it unalterable over time. Its high resistance to heat, wear and thermal ageing makes PET one of the most innovative, future-oriented materials.**

HANDLES

see page 28-31

CARCASSES

DOORS: lava grey larch with clay rear, lava grey mortar with clay rear, matt fossena grey with clay rear, matt blu dusty with clay rear
standard: melamine-coated clay (opt.9690) clay back panel and shelf (opt.9690)

DOORS: shell larch with shell rear, sand mortar with shell rear, matt soft sand with shell rear
standard: melamine-coated shell (opt.8910) shell back panel and shelf (opt.8910)

DOORS: white larch with white rear, absolute white mortar with white rear, matt optical white with white rear, matt veiled grey with white rear
standard: melamine-coated white (opt.001), white back panel and shelf (opt.001)

DOORS: mink larch with mink rear, mink mortar with mink rear, matt deer with mink rear, sand elm with mink rear, matt sedona red with mink rear, matt beryl green with mink rear
standard: melamine-coated mink (opt.948M) mink back panel and shelf (opt.948M)

DOORS: black ash with blackboard rear, grey asphalt mortar with blackboard rear, oil elm with blackboard rear, matt lakis grey with blackboard rear
standard: melamine-coated slate grey (opt.9620) slate grey back panel and shelf (opt.9620)

DOORS: tobacco elm with mud rear, dark elm with mud rear, matt brown earth with mud rear
standard: melamine-coated mud (opt.8860) mud back panel and shelf (opt.8860)

SHELVES

see page 54

PLINTHS

see page 55



SP. 22 MM TH. 22 MM

ante effetto legno materico post-formate 4 lati
doors with textured wood effect post-formed on 4 sides

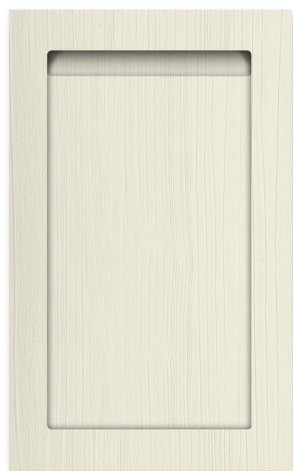

larice bianco
retro bianco (opz.2414N)
white larch with white rear



larice grigio lava
retro argilla (opz.2417N)
lava grey larch with clay rear
N.B.: disponibile a partire da Novembre 2022
Note: available from November 2022



larice conchiglia
retro conchiglia (opz.2415N)
shell larch with shell rear
N.B.: disponibile a partire da Novembre 2022
Note: available from November 2022



larice visone
retro visone (opz.2416N)
mink larch with mink rear
N.B.: disponibile a partire da Novembre 2022
Note: available from November 2022



larice nero
retro lavagna (opz.2418N)
black larch with blackboard rear

ante effetto legno post-formate 4 lati
doors with wood effect post-formed on 4 sides



olmo sabbia
retro visone (opz.5077)
sand elm with mink rear



olmo tabacco
retro fango (opz.5078)
tobacco elm with mud rear



olmo scuro
retro fango (opz.5079)
dark elm with mud rear



olmo petrolio
retro lavagna (opz.5080)
oil elm with blackboard rear



particolare presa
maniglia
detailed
handle grip

N.B.: per schemi maniglia vedi pag.51
Note: for handle diagrams see page 51

Round Frame

Bridge cod. **B16**

SP. 22 MM TH. 22 MM

ante tinta unita opache post-formate 4 lati
doors with solid matt colour post-formed 4 sides



bianco ottico
retro bianco (opz.7465)
optical white with white rear

grigio fossena
retro argilla (opz.9616)
fossena grey with clay rear

sabbia tenue
retro conchiglia (opz.7718)
soft sand with shell rear

daino
retro visone (opz.9455)
deer with mink rear

terra bruna
retro fango (opz.8845)
brown earth with mud rear

grigio lakis
retro lavagna (opz.9618)
lakis grey with blackboard rear



rosso sedona
retro visone (opz.8132)
sedona red with mink rear

verde berillo
retro visone (opz.8422)
beryl green with mink rear

grigio velato
retro bianco (opz.9600)
veiled grey with white rear

blu dusty
retro argilla (opz.8324)
blu dusty with clay rear

ante effetto malta materico post-formate 4 lati
doors with textured mortar effect post-formed 4 sides



malta bianco assoluto
retro bianco (opz.PM01N)
absolute white mortar with white rear

malta grigio lava
retro argilla (opz.PM04)
lava grey mortar with clay rear

malta sabbia
retro conchiglia (opz.PM02N)
sand mortar with shell rear

malta visone
retro visone (opz.PM03)
mink mortar with mink rear

malta grigio asfalto
retro lavagna (opz.PM05)
grey asphalt mortar with blackboard rear

SCHEMA PRESA MANIGLIA FRAME FRAME HANDLES GRIP DIAGRAM

Angolo pensile a libro
Corner wall unit folding

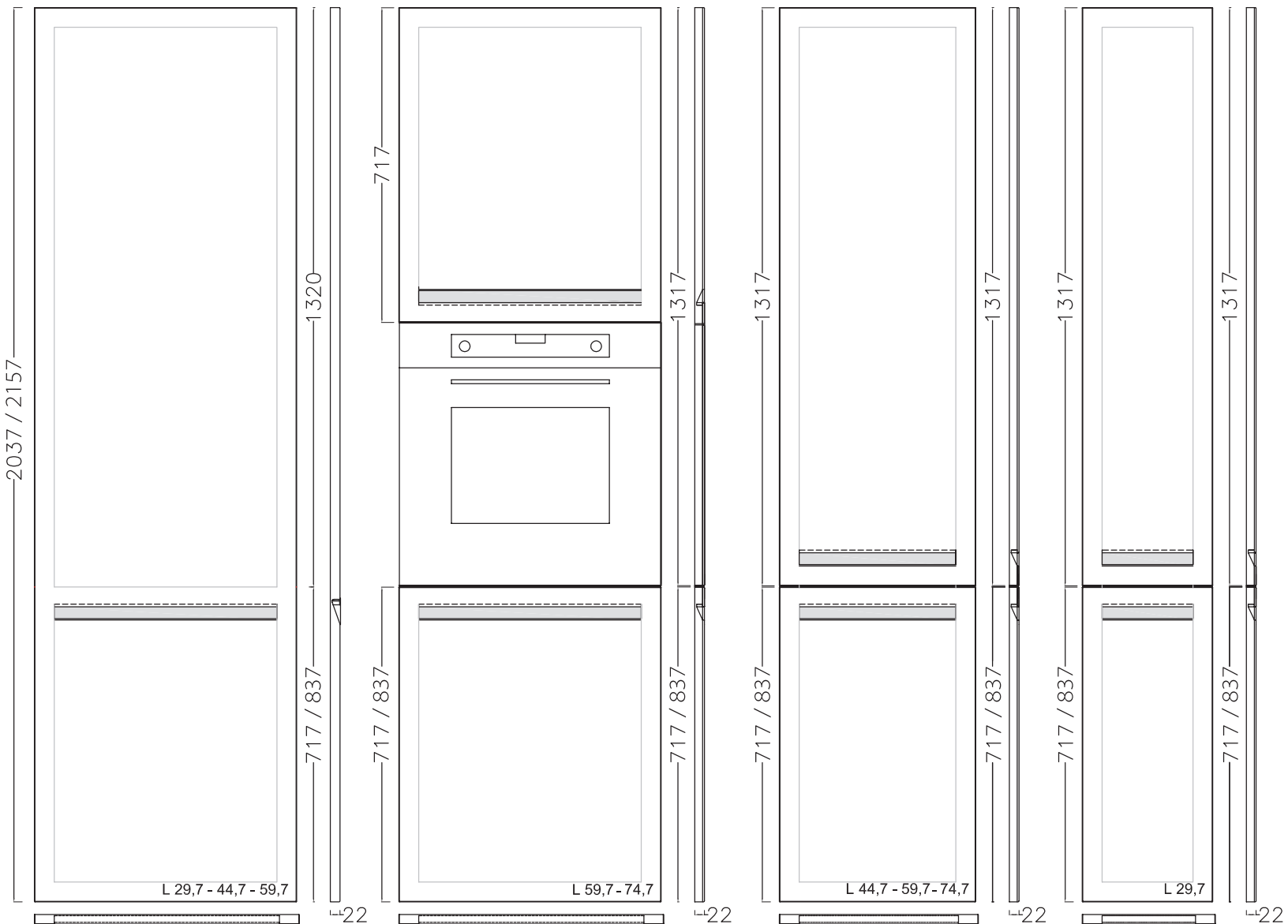
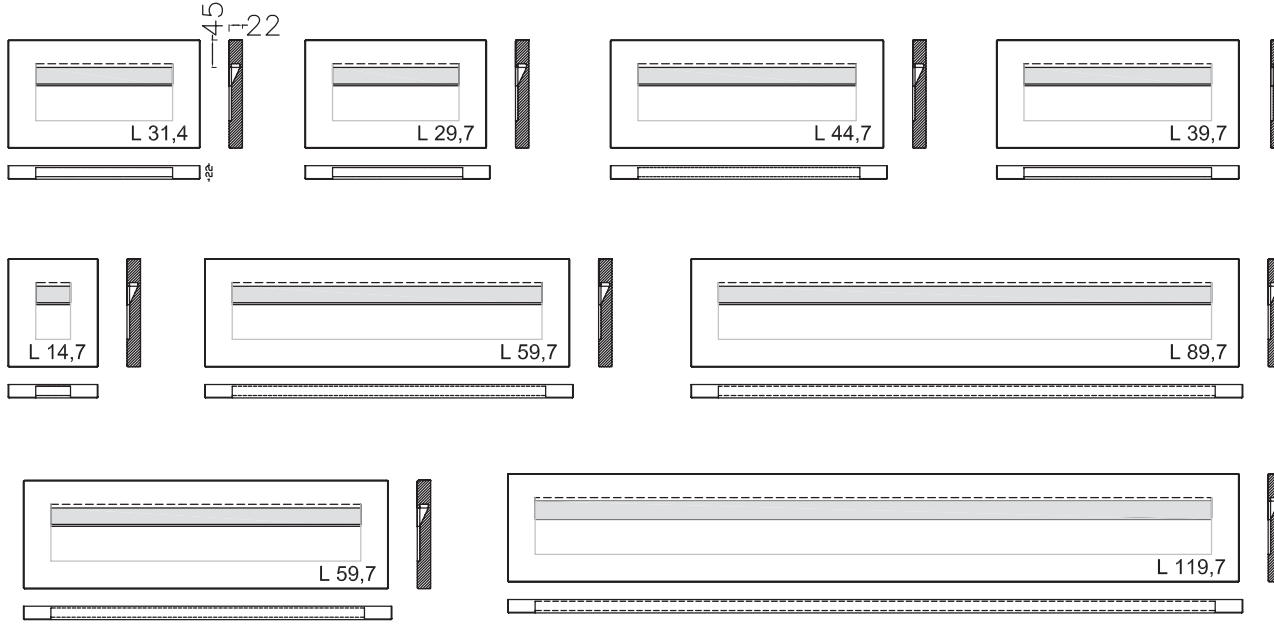

Telaio alluminio

Aluminium frame

di serie: telaio alluminio verniciato sp.22 mm, con presa maniglia incorporata 4 lati
vetro bronzo serigrafato effetto tessuto trama larga

standard: 22 mm-thick coated aluminium frame with recessed handle grip 4 sides
silkscreen bronze glass open weave fabric effect

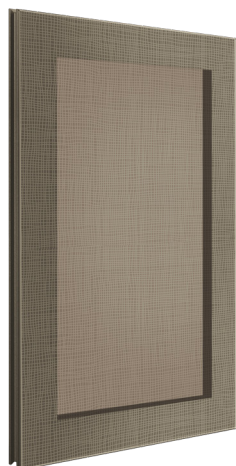

telaio grigio selce con vetro
bronzo serigrafato
(opt.SERBS)
flint grey frame with silkscreen
bronze glass
(opt.SERBS)

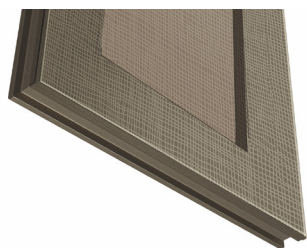

particolare maniglia incorporata 4 lati
telaio grigio selce
detail of recessed handle 4 sides
flint grey frame

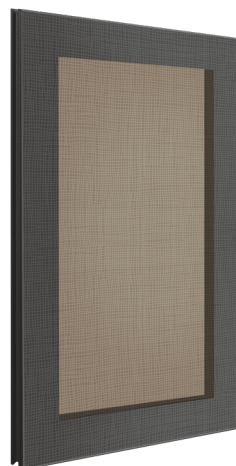

telaio ghisa con vetro
bronzo serigrafato
(opt.GHRBS)
cast iron frame with silkscreen
bronze glass
(opt.GHRBS)

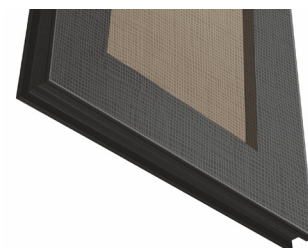

particolare maniglia incorporata 4 lati
telaio ghisa
detail of recessed handle 4 sides
cast iron frame

di serie: telaio alluminio verniciato sp.22 mm, con presa maniglia incorporata 4 lati
vetro fumè serigrafato effetto tessuto trama larga

standard: 22 mm-thick coated aluminium frame, with recessed handle grip 4 sides
smoked glass silkscreen open weave fabric effect

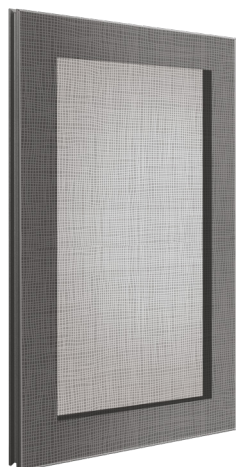

telaio silver dark con vetro
fumè serigrafato
(opt.DARFS)
dark silver frame with silkscreen
smoked glass
(opt.DARFS)



particolare maniglia incorporata 4 lati
telaio silver dark
detail of recessed handle 4 sides
dark silver frame

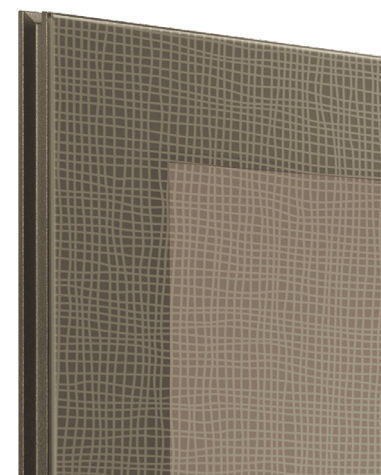

particolare trama vetro
detail of glass weave

Telaio alluminio

Aluminium frame

a richiesta: telaio alluminio verniciato sp.22 mm, con presa maniglia incorporata 4 lati
vetro bronzo trasparente

on request: 22 mm-thick coated aluminium frame, with recessed handle grip 4 sides
transparent bronze glass



telaio grigio selce con vetro
bronzo trasparente
(opz.SERBT)
flint grey frame with transparent
bronze glass
(opt.SERBT)

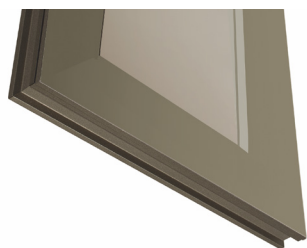

particolare maniglia incorporata 4 lati
telaio grigio selce
detail of recessed handle 4 sides
flint grey frame



telaio ghisa con vetro
bronzo trasparente
(opz.GHRBT)
cast iron frame with transparent
bronze glass
(opt.GHRBT)

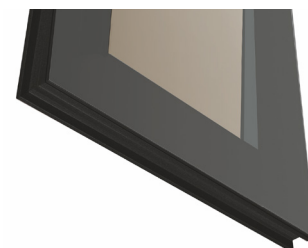

particolare maniglia incorporata 4 lati
telaio ghisa
detail of recessed handle 4 sides
cast iron frame

a richiesta: telaio alluminio verniciato sp.22 mm, con presa maniglia incorporata 4 lati
vetro fumè trasparente

on request: 22 mm-thick coated aluminium frame, with recessed handle grip 4 sides
transparent smoked glass



telaio silver dark con vetro
fumè trasparente
(opz.DARFT)
dark silver frame with transparent
smoked glass
(opt.DARFT)



particolare maniglia incorporata 4 lati
telaio silver dark
detail of recessed handle 4 sides
dark silver frame



particolare vetro
detail of glass

strutture carcasses



bianco (opz.001)
schiena e ripiano bianco
(opz.001)
white (opt.001)
white back panel and shelf
(opt.001)



visone (opz.948M)
schiena e ripiano visone
(opz.948M)
mink (opt.948M)
mink back panel and shelf
(opt.948M)

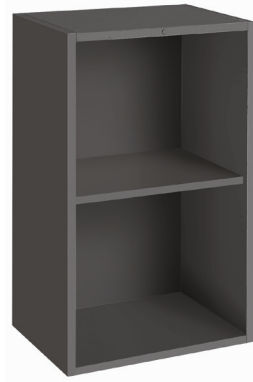

lavagna (opz.9620)
schiena e ripiano lavagna
(opz.9620)
slate grey (opt.9620)
slate grey back panel
and shelf (opt.9620)

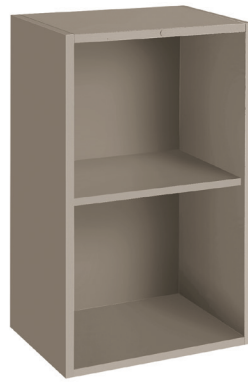

fango (opz.8860)
schiena e ripiano fango
(opz.8860)
mud (opt.8860)
mud back panel and shelf
(opt.8860)



conchiglia (opz.8910)
schiena e ripiano conchiglia
(opz.8910)
shell (opt.8910)
shell back panel and shelf
(opt.8910)

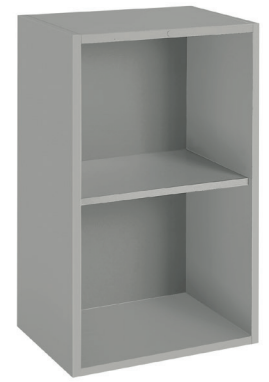

argilla (opz.9690)
schiena e ripiano argilla
(opz.9690)
clay (opt.9690)
clay back panel and shelf
(opt.9690)



GRUPPO LUBE ECOLOGIC
IL GRUPPO LUBE UTILIZZA
PER I COMPONENTI DELLE CUCINE*,
MATERIALE CONFORME AL
REGOLAMENTO EPA TSCA TITLE VI,
UNO DEI PIU' SEVERI IN MERITO
ALLE NORMATIVE DI
SALVAGUARDIA AMBIENTALE.

*per componenti di intonaco tutte le strutture,
alcune ante e alcuni complementi del modello.



GREENGUARD
LE STRUTTURE DELLE CUCINE
SONO CONTRADDISTINTE
DALLA CERTIFICAZIONE
GREENGUARD GOLD PER
SODDISFARE GLI STANDARD
PIU' RIGOROSI IN TERMINI
DI LIVELLI DI EMISSIONE
DI COMPOSTI ORGANICI
VOLATILI (COV).

mensole in laminato P 31-61 come strutture same colours as carcasses laminate shelves D 31-61



bianco (opz.001)
white (opt.001)

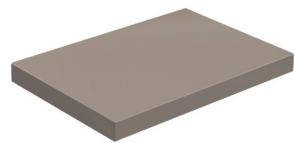

visone (opz.948M)
mink (opt.948M)

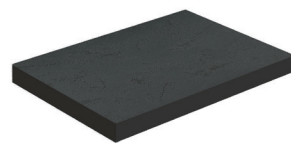

lavagna (opz.9620)
slate grey (opt.9620)

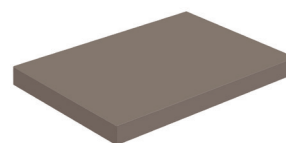

fango (opz.8860)
mud (opt.8860)

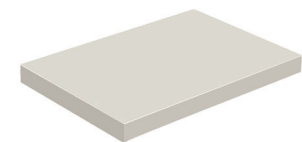

conchiglia (opz.8910)
shell (opt.8910)

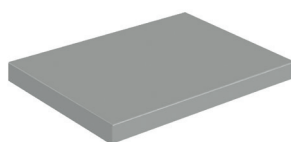

argilla (opz.9690)
clay (opt.9690)

mensole in PET PET shelves



N.B.: per le finiture vedi pagine 9-10-11
Note: for finishes see pages 9-10-11

zoccoli in pvc H 13 pvc plinth H 13



acciaio (opz.407)
steel (opt.407)



bianco (opz.001)
white (opt.001)

di serie
standard

N.B.: non disponibili per elementi curvi
Note: not available for curved elements

zoccoli in alluminio H 13 aluminium plinth H 13



alluminio finitura titanio
ossidato (opz.414)
aluminium titanium
oxidized finish (opt.414)

zoccoli in alluminio H 13 verniciati a polvere finitura opaca aluminum plinth height H 13 powder coated matt finish



alluminio finitura bianco
assoluto (opz.740S)
aluminium absolute
white finish (opt.740S)



alluminio lino
(opz.W770)
aluminium linen
(opt.W770)



alluminio finitura
grigio selce (opz.SE)
aluminium flint grey
finish (opt.SE)



alluminio finitura
ghisa (opz.9509)
aluminium cast iron
finish (opt.9509)



alluminio finitura
silver dark (opz.9507)
aluminium dark silver
finish (opt.9507)



alluminio finitura nero
(opz.7892)
aluminium
black finish (opt.7892)

MODULARITÀ E COMPONIBILITÀ MODULARITY AND FITTING SOLUTIONS

COLONNE FRIGO
FRIDGE COLUMNS

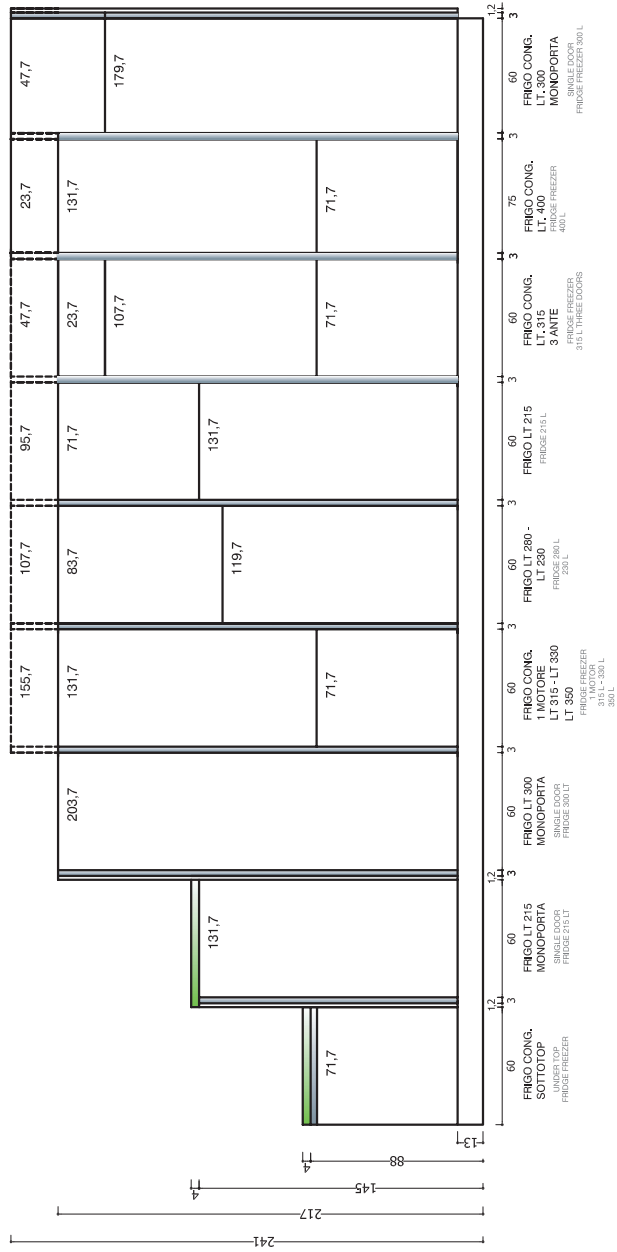
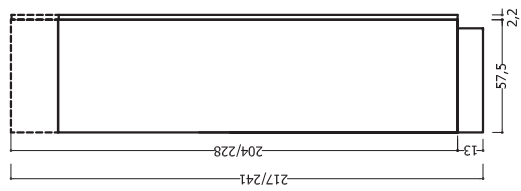

COLONNE FORNO
OVEN COLUMNS

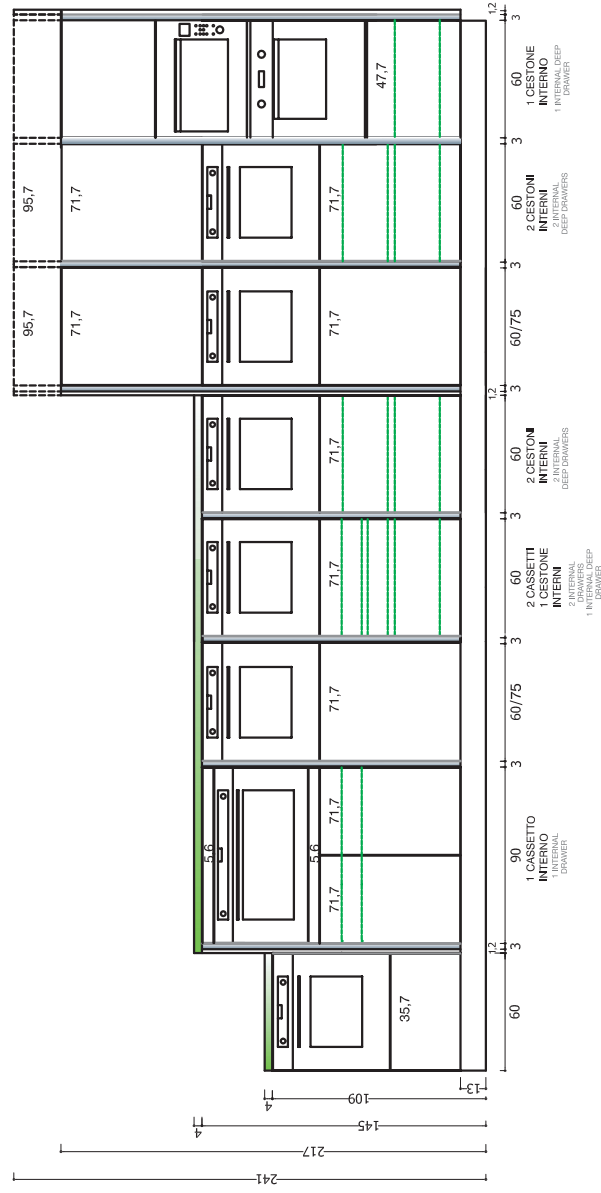

MODULARITÀ E COMPONIBILITÀ MODULARITY AND FITTING SOLUTIONS

- ESCLUSO 85
EXCLUDING 85
- ESCLUSO 85
EXCLUDING 85
- ESCLUSO 45
EXCLUDING 45
- ESCLUSO 130
EXCLUDING 130
- ESCLUSO 130
EXCLUDING 130

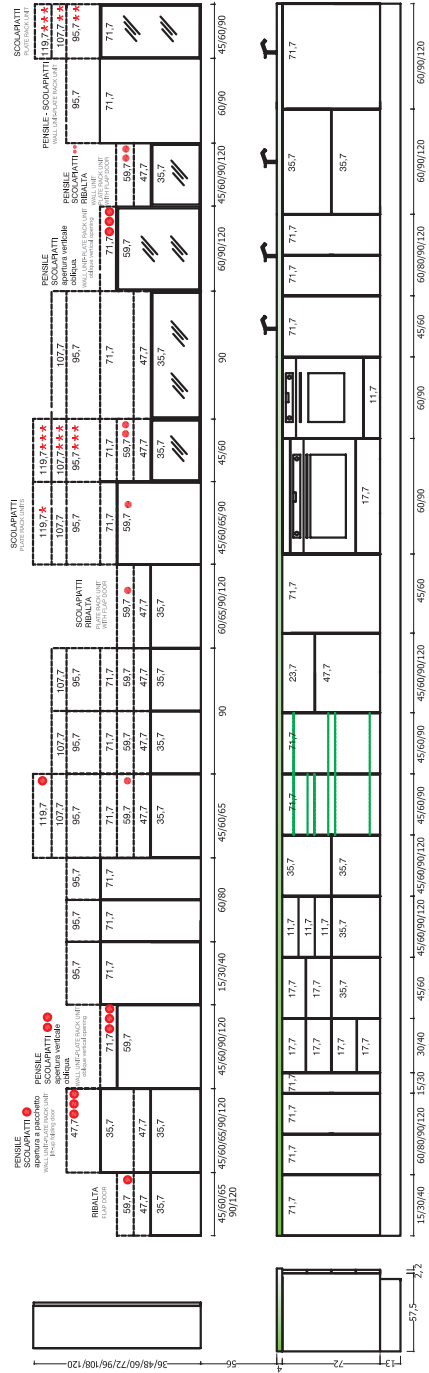

BASI H 73
BASE UNITS H 73

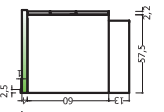

BASI SOSPENSE
HANGING BASE UNITS

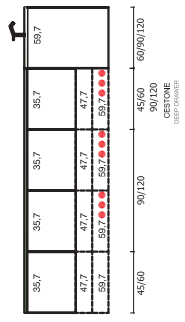

BASI LIVING
ROOM UNITS

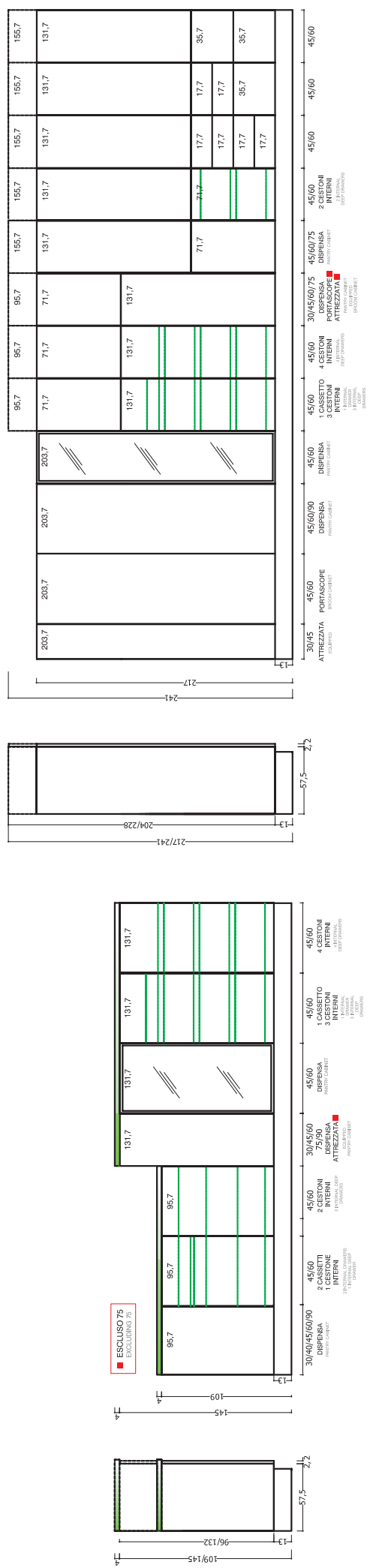
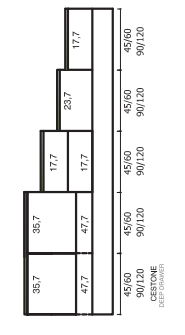

APERTURA A RIBALTA

Le ante aprendosi verso l'alto consentono di avere un' ampia visione d'insieme all'interno del mobile.

La regolazione della forza di apertura può essere impostata in modo esatto in base al peso del frontale. Grazie all'arresto progressivo le ante si fermano in qualsiasi posizione; in questo modo la maniglia è sempre facilmente raggiungibile. La chiusura è ammortizzata e un'unica manovra è sufficiente per regolare il frontale tridimensionalmente grazie all'assenza di cerniere e al sistema di aggancio clip.

WALL UNIT WITH FLAP DOOR

The doors that open upwards guarantee ample overall visibility inside the cabinet.

The opening force can be adjusted precisely according to the weight of the front. The doors stop in any position thanks to the gradual stopping movement; in this way, the handle is always easily accessible. The closing movement is cushioned and a single manoeuvre is required to three-dimensionally adjust the front, thanks to the clip-on system and the absence of hinges.



DI SERIE
STANDARD



MOTORIZZATO
SERVO-DRIVE
SERVO-DRIVE
MOTORISED
(Opz.007)
maggiorazione
surcharge

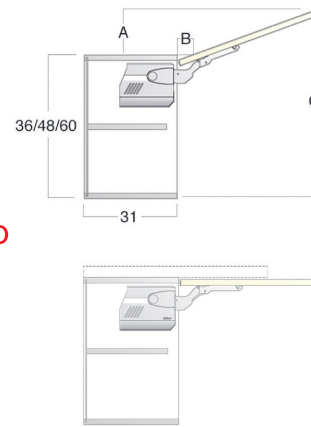

	A	B	C
H 36	11	3,5	47
H 48	15	3,5	63
H 60	18,5	3,5	78,5

Per evitare l'interferenza dell'anta in fase di apertura con cornici o mensole, si può richiedere il limitatore dell'angolo di apertura cod. 5620010

In order to avoid that the door interferes with cornices or shelves during the opening movement, it is possible to request an opening angle limiter: code 5620010

SCHEMA MONTAGGIO LIMITATORE PER RIBALTA H 36
FLAP DOOR LIMITER INSTALLATION DIAGRAM H 36

SCHEMA MONTAGGIO LIMITATORE PER RIBALTA H 48
FLAP DOOR LIMITER INSTALLATION DIAGRAM H 48

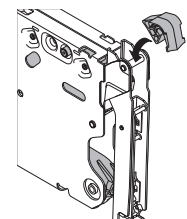
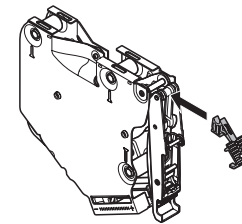

APERTURA VERTICALE OBLIQUA

I pensili con questo tipo di meccanismo necessitano per l'apertura di poco spazio libero sopra il mobile grazie al movimento basculante dell'anta che si apre senza difficoltà applicando poca forza anche in presenza di frontali pesanti. Con l'arresto progressivo le ante si fermano in qualsiasi posizione; in questo modo la maniglia è sempre facilmente raggiungibile. La chiusura è ammortizzata ed è possibile regolare la forza di tenuta in base al peso del frontale.

VERTICAL OPENING OBLIQUE

Wall units that mount this type of mechanism require little clearance above the cabinet thanks to the swivelling movement of the door that can be easily opened by applying slight pressure, even with heavy fronts. The doors stop in any position thanks to the gradual stopping movement; in this way, the handle is always easily accessible. The closing movement is cushioned and the closing force can be adjusted according to the weight of the front door.



DI SERIE
STANDARD



MOTORIZZATO
SERVO-DRIVE
SERVO-DRIVE
MOTORISED
(Opz.007)
maggiorazione
surcharge

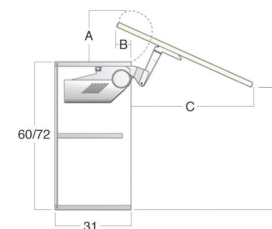

	A	B	C	D
H 60	18	9,6	46,5	53,5
H 72	18	9,6	57	61

APERTURA VERTICALE

L'anta ad apertura verticale, potendo essere sollevata completamente verso l'alto, consente un accesso totale all'interno del pensile. Ideale per l'impiego in mobili a colonna per nascondere ad esempio apparecchi elettrici, o pensili con corpi mobili sovrastanti, ha la chiusura ammortizzata e la possibilità di regolare la forza di tenuta in base al peso del frontale.

VERTICAL OPENING

Doors with vertical opening movement can be fully raised to fully access the inside of the wall unit. Ideal for use on column units to conceal electrical appliances for examples, or on wall units surmounted by mobile units. The closing movement is cushioned and the closing force can be adjusted according to the weight of the front door.



**DI SERIE
STANDARD**



**MOTORIZZATO
SERVO-DRIVE**
SERVO-DRIVE
MOTORISED
(Opz.007)
**maggiorazione
surcharge**

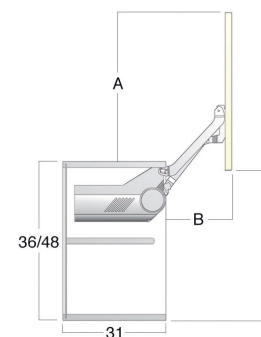

	A	B	C
H 36	35	23,5	34,5
H 48	44	28,5	43,5

APERTURA ANTE A PACCHETTO

Il meccanismo d'apertura ante a pacchetto è idoneo sul pensile H 72; la regolazione della forza di apertura può essere impostata in modo esatto in base ai pesi dei frontali, la chiusura è ammortizzata e la cerniera centrale clip si contraddistingue per l'innovativa tecnologia che garantisce la sicurezza per le dita.

LIFT-UP FOLDING DOORS

The lift-up folding door opening mechanism is suitable for wall units with H 72; the opening force can be adjusted precisely according to the weight of the fronts, while the closing movement is cushioned and the central clip-on hinge features innovative technology for safeguarding the fingers.



**DI SERIE
STANDARD**



**MOTORIZZATO
SERVO-DRIVE**
SERVO-DRIVE
MOTORISED
(Opz.007)
**maggiorazione
surcharge**

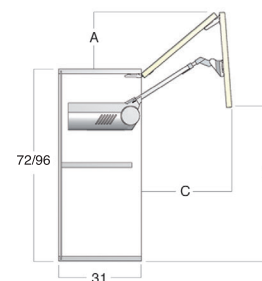

	A	B	C
H 72	19,5	54	41
H 96	24,7	69	53

**SCHEMA MONTAGGIO
LIMITATORE
LIMITER INSTALLATION
DIAGRAM**

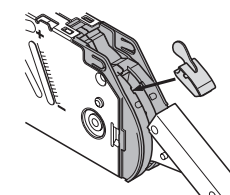

Per evitare l'interferenza dell'anta in fase di apertura con cornici o mensole, si può richiedere il limitatore dell'angolo di apertura cod. 5620005

In order to avoid that the door interferes with cornices or shelves during the opening movement, it is possible to request an opening angle limiter: code 5620005

COLONNE ARMADIO “NOOK” H 217 P 70,5 CON ANTE A SCOMPARSA

“NOOK” CLOSET COLUMNS H 217 D 70,5 WITH DOORS INWARDS

Le colonne armadio “Nook” con ante a scomparsa, consentono di inserire all’interno forno, frigo, tavolo e cassetti

“Nook” closet columns with pull-out doors allow to insert oven, fridge, table and drawer on the inside



COLONNE ARMADIO “NOOK” H 217 P 70,5 CON ANTE A SCOMPARSA

“NOOK” CLOSET COLUMNS H 217 D 70,5 WITH DOORS INWARDS

Il tavolo estraibile è disponibile nella versione inox o in laminato, nella finitura oak cognac

The pull-out table it's available in stainless steel version or laminate oak cognac finish



ZOCCOLO
H 6 centimetri
=
più volume di
contenimento

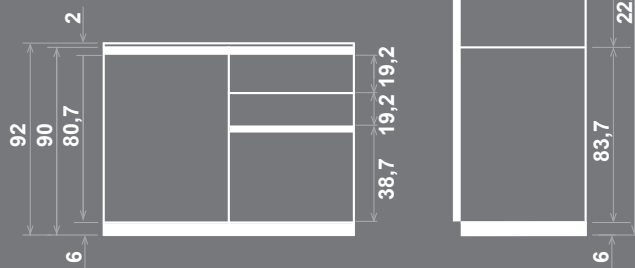

Con lo **zoccolo** ad altezza ridotta a 6 cm, si possono **guadagnare centimetri preziosi di contenimento**, dando alla cucina l'aspetto elegante di un living.

Valuable space has been saved by lowering the plinth to 6 cm, and so the kitchen will take on a stylish look such as a living room.



strutture carcasses



bianco (opz.001)
schiena e ripiano bianco
(opz.001)
white
white back panel and shelf

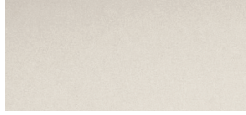

conchiglia (opz.8910)
schiena e ripiano conchiglia
(opz.8910)
shell
shell back panel and shelf



lavagna (opz.9620)
schiena e ripiano lavagna
(opz.9620)
slate grey
slate grey back panel and shelf



fango (opz.8860)
schiena e ripiano fango
(opz.8860)
mud
mud back panel and shelf



visone (opz.948M)
schiena e ripiano visone
(opz.948M)
mink
mink back panel and shelf



argilla (opz.9690)
schiena e ripiano argilla
(opz.9690)
clay
clay back panel and shelf

zoccoli in alluminio H 6 aluminium plinths H 6

di serie
standard



alluminio finitura titanio
ossidato (opz.414)
aluminium titanium
oxidized finish (opt.414)

zoccoli in alluminio H 6 verniciati a polvere finitura opaca aluminum plinths H 6 powder coated matt finish

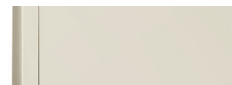

alluminio lino
(opz.W770)
aluminium linen
(opt.W770)

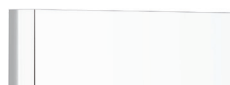

alluminio finitura
bianco assoluto (opz.740S)
aluminium absolute
white finish (opt.740S)



alluminio finitura
grigio selce (opz.SE)
aluminium flint grey
finish (opt.SE)



alluminio finitura
ghisa (opz.9509)
aluminium cast iron
finish (opt.9509)



alluminio finitura
silver dark (opz.9507)
aluminium dark silver
finish (opt.9507)



alluminio finitura nero
(opz.7892)
aluminium
black finish (opt.7892)

MODULARITÀ E COMPONENTIBILITÀ MODULARITY AND FITTING SOLUTIONS



● ESCLUSO 120
EXCLUDING 120

★ SOLO 90
ONLY 90

MODULARITÀ E COMPONIBILITÀ MODULARITY AND FITTING SOLUTIONS

COLONNE
COLUMNS

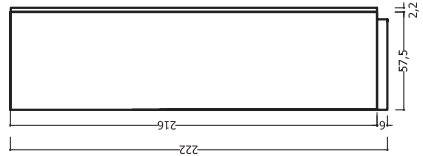

COLONNE FRIGO
FRIDGE COLUMNS

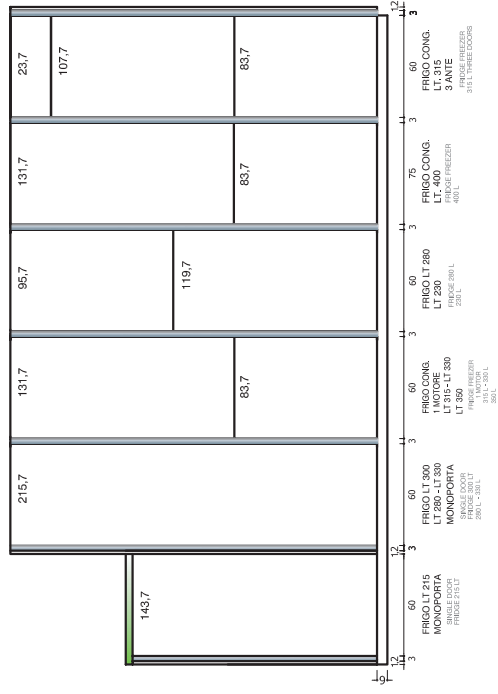
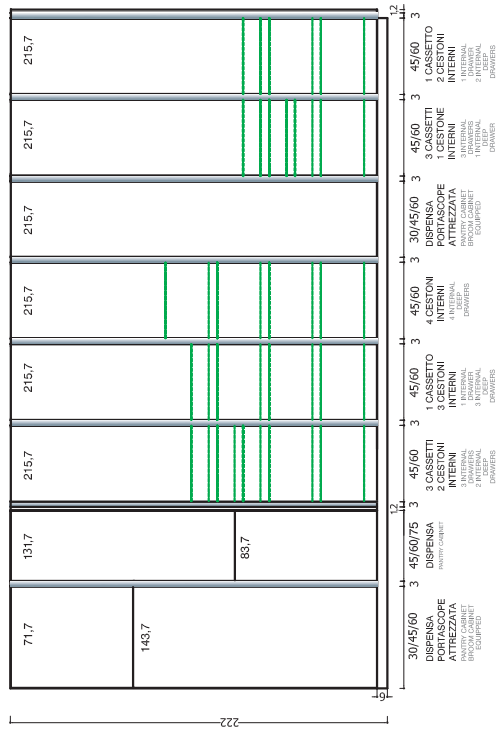
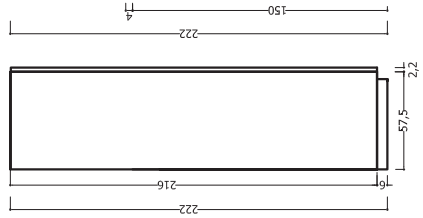

COLONNE FORNO
OVEN COLUMNS

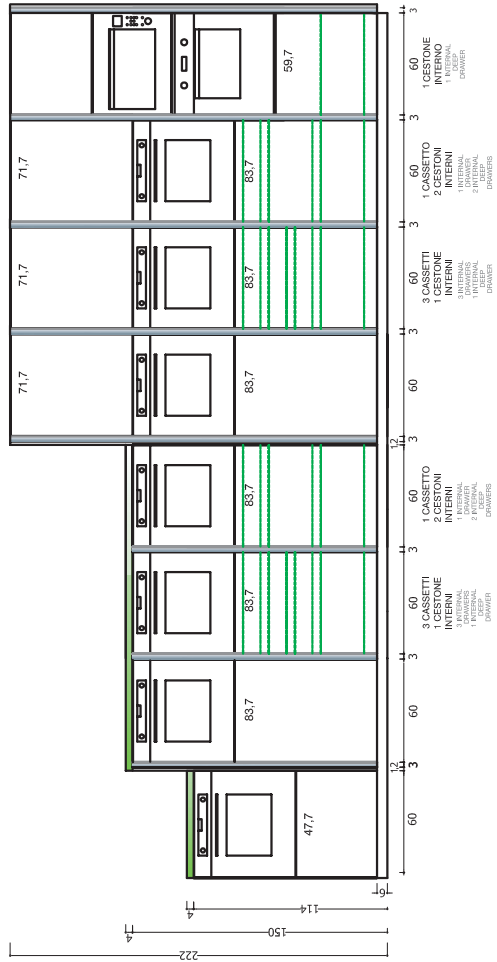
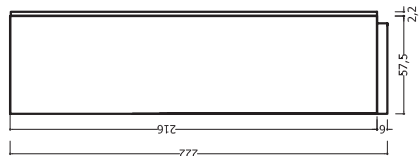

ZOCCOLO
H 6 centimetri
=
più volume di
contenimento

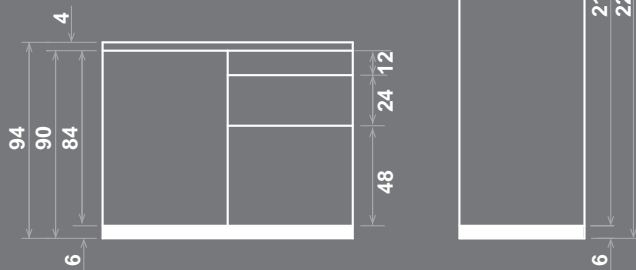

Con lo zoccolo ad altezza ridotta a 6 cm, si possono guadagnare centimetri preziosi di contenimento, dando alla cucina l'aspetto elegante di un living.

Valuable space has been saved by lowering the plinth to 6 cm, and so the kitchen will take on a stylish look such as a living room.



strutture carcasses



bianco (opz.001)
schiena e ripiano bianco
(opz.001)
white
white back panel and shelf



conchiglia (opz.8910)
schiena e ripiano conchiglia
(opz.8910)
shell
shell back panel and shelf



lavagna (opz.9620)
schiena e ripiano lavagna
(opz.9620)
slate grey
slate grey back panel and shelf



fango (opz.8860)
schiena e ripiano fango
(opz.8860)
mud
mud back panel and shelf



visone (opz.948M)
schiena e ripiano visone
(opz.948M)
mink
mink back panel and shelf



argilla (opz.9690)
schiena e ripiano argilla
(opz.9690)
clay
clay back panel and shelf

zoccoli in alluminio H 6 aluminium plinths H 6

di serie
standard



alluminio finitura titanio
ossidato (opz.414)
aluminium titanium
oxidized finish (opt.414)

zoccoli in alluminio H 6 verniciati a polvere finitura opaca aluminum plinths H 6 powder coated matt finish



alluminio lino
(opz.W770)
aluminium linen
(opt.W770)



alluminio finitura
bianco assoluto (opz.740S)
aluminium absolute
white finish (opt.740S)



alluminio finitura
grigio selce (opz.SE)
aluminium flint grey
finish (opt.SE)



alluminio finitura
ghisa (opz.9509)
aluminium cast iron
finish (opt.9509)



alluminio finitura
silver dark (opz.9507)
aluminium dark silver
finish (opt.9507)



alluminio finitura nero
(opz.7892)
aluminium
black finish (opt.7892)



ANTE VETRO
GLASS DOORS



telaio con vetro
bronzo serigrafato
frame with silkscreen
bronze glass

per colori vedi pag.56
for colours see page 56



telaio con vetro
bronzo trasparente
frame with transparent
bronze glass

per colori vedi pag.57
for colours see page 57

COLORI STRUTTURA INTERNA IN NOBILITATO
COLOURS FOR INTERNAL MELAMINE-COATED STRUCTURE

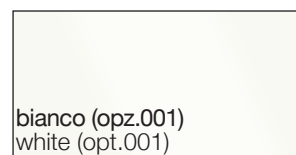

bianco (opz.001)
white (opt.001)

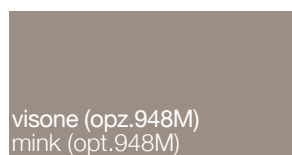

visone (opz.948M)
mink (opt.948M)

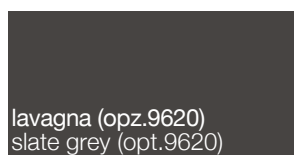

lavagna (opz.9620)
slate grey (opt.9620)

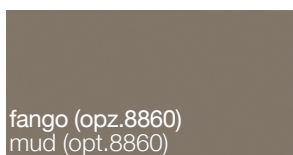

fango (opz.8860)
mud (opt.8860)

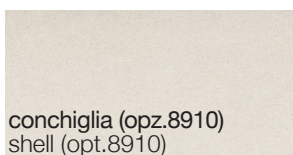

conchiglia (opz.8910)
shell (opt.8910)

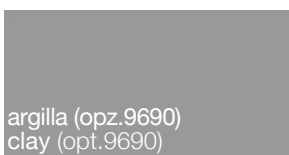

argilla (opz.9690)
clay (opt.9690)

COLORI ANTE CHIUSE E PANNELLI FISSI FRONTALE E LATERALE
COLOURS FOR DOORS AND FIXED FRONT LATERAL PANELS

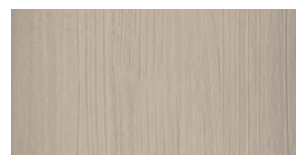

EFFETTO LEGNO MATERICO per colori vedi pag.9
TEXTURED WOOD EFFECT for colours see page 9

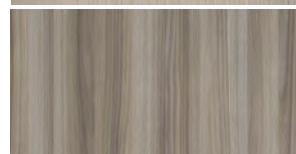

EFFETTO LEGNO per colori vedi pag.9
WOOD EFFECT COLOURS for colours see page 9

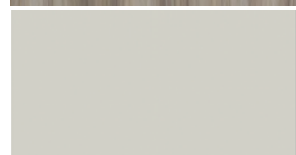

TINTA UNITÀ OPACHE per colori vedi pag.10
SOLID MATT COLOURS for colours see page 10



EFFETTO MALTA MATERICO per colori vedi pag.11
TEXTURED MORTAR EFFECT for colours see page 11

ELEMENTI A GIORNO IN LAMIERA VERNICIATI A POLVERE SP.2 MM

POWDER PAINTED METAL SHEET OPEN UNITS TH.2 MM



COLORI FREDDI OPACHI SOFT SOFT MATT COLD COLOURS



bianco assoluto (opz.740S)
absolute white

cenere (opz.9547)
ash

argilla (opz.9503)
clay

grigio bromo (opz.9533)
bromine grey

nero seppia (opz.7897)
cuttlefish ink

nebbia (opz.95F5)
fog

grigio traffico (opz.9511)
traffic grey



blu cristal (opz.8381)
crystal blue

nero (opz.7892)
black

COLORI CALDI OPACHI SOFT SOFT MATT HOT COLOURS

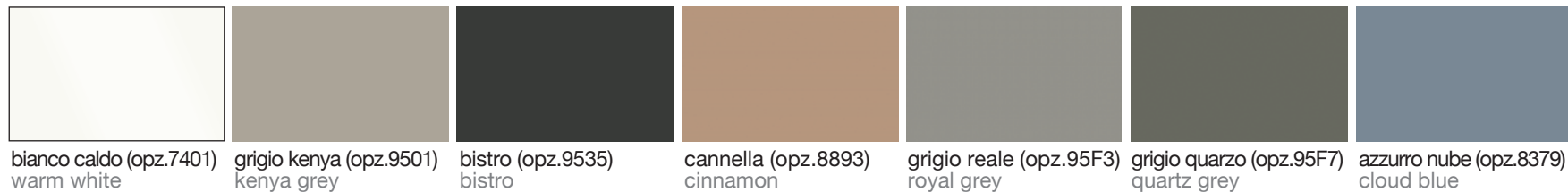

bianco caldo (opz.7401)
warm white

grigio kenya (opz.9501)
kenya grey

bistro (opz.9535)
bistro

cannella (opz.8893)
cinnamon

grigio reale (opz.95F3)
royal grey

grigio quarzo (opz.95F7)
quartz grey

azzurro nube (opz.8379)
cloud blue



conchiglia (opz.7403)
seashell

lino (opz.9513)
linen

creta (opz.9515)
clay

rosso persia (opz.8165)
persia red

giallo zafferano (opz.8253)
saffron yellow

verde bosco (opz.8468)
forest green

fumo (opz.9531)
smoke



grigio lava (opz.95F1)
lava grey

polvere (opz.9539)
dust

platino (opz.7773)
platinum

nocciola (opz.7775)
walnut

cuoio (opz.8897)
leather

tortora (opz.8993)
dove grey

rosso (opz.125S)
red

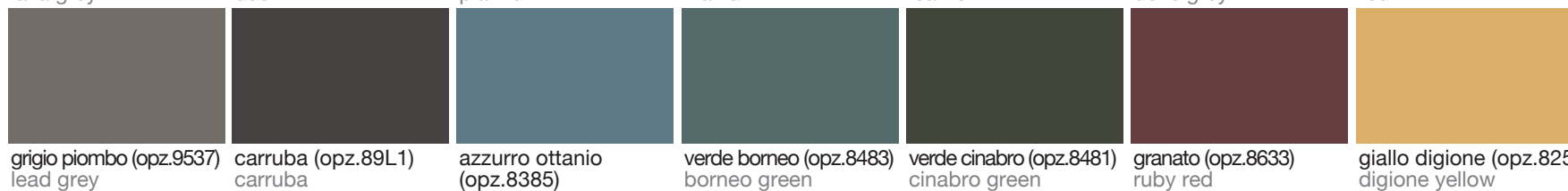

grigio piombo (opz.9537)
lead grey

carruba (opz.89L1)
carruba

azzurro ottanio
(opz.8385)
teal blue

verde borneo (opz.8483)
borneo green

verde cinabro (opz.8481)
cinabro green

granato (opz.8633)
ruby red

giallo digione (opz.8257)
digione yellow

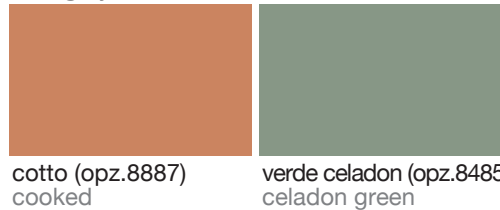

cotto (opz.8887)
cooked

verde celadon (opz.8485)
celadon green

ELEMENTI A GIORNO SP. 14 MM

OPEN ELEMENTS TH.14 MM



COLORI FREDDI OPACHI SOFT SOFT MATT COLD COLOURS



bianco assoluto (opz.740S) absolute white
 cenere (opz.9547) ash
 argilla (opz.9503) clay
 grigio bromo (opz.9533) bromine grey
 nero seppia (opz.7897) cuttlefish ink
 nebbia (opz.95F5) fog
 grigio traffico (opz.9511) traffic grey



blu cristal (opz.8381) crystal blue
 nero (opz.7892) black

COLORI CALDI OPACHI SOFT SOFT MATT HOT COLOURS



bianco caldo (opz.7401) warm white
 grigio kenya (opz.9501) kenya grey
 bistro (opz.9535) bistro
 cannella (opz.8893) cinnamon
 grigio reale (opz.95F3) royal grey
 grigio quarzo (opz.95F7) quartz grey
 azzurro nube (opz.8379) cloud blue



conchiglia (opz.7403) seashell
 lino (opz.9513) linen
 creta (opz.9515) clay
 rosso persia (opz.8165) persia red
 giallo zafferano (opz.8253) saffron yellow
 verde bosco (opz.8468) forest green
 fumo (opz.9531) smoke

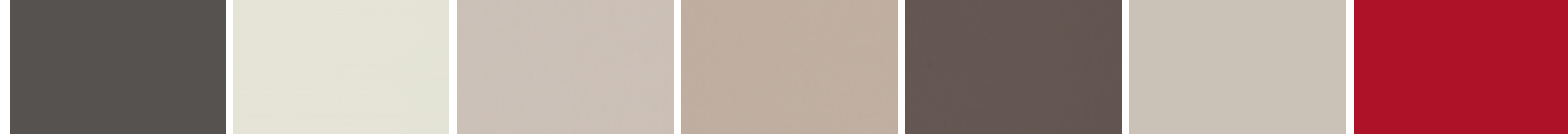

grigio lava (opz.95F1) lava grey
 polvere (opz.9539) dust
 platino (opz.7773) platinum
 nocciola (opz.7775) walnut
 cuoio (opz.8897) leather
 tortora (opz.8993) dove grey
 rosso (opz.125S) red



grigio piombo (opz.9537) lead grey
 carruba (opz.89L1) carruba
 azzurro ottanio (opz.8385) teal blue
 verde borneo (opz.8483) borneo green
 verde cinabro (opz.8481) cinabro green
 granato (opz.8633) ruby red
 giallo digione (opz.8257) digione yellow



cotto (opz.8887) cooked
 verde celadon (opz.8485) celadon green

ELEMENTI TERMINALI A GIORNO con fascia in metallo

OPEN END UNITS with metal panel



colori struttura carcass colours

malta bianco assoluto (opz.PM01N) absolute white mortar	malta sabbia (opz.PM02N) sand mortar	malta visone (opz.PM03) mink mortar	malta grigio lava (opz.PM04) lava grey mortar	malta grigio asfalto (opz.PM05) grey asphalt mortar
bianco ottico (opz.7465) optical white	grigio fossena (opz.9616) fossena grey	sabbia tenue (opz.7718) soft sand	daino (opz.9455) deer	terra bruna (opz.8845) brown earth
grigio laks (opz.9618) lakis grey	rosso sedona (opz.8132) sedona red	verde berillo (opz.8422) beryl green	grigio velato (opz.9600) veiled grey	blu dusty (opz.8324) blu dusty

colori per fascia in metallo colours for metal panel

grigio selce (opz.955E) flint grey	ghisa (opz.9509) cast iron	nero (opz.7892) black	silver dark (opz.9507) dark silver
--	----------------------------------	-----------------------------	--

ELEMENTI A GIORNO "CODE"

"CODE" OPEN UNITS



colori mensole

colours shelves



colori montanti in metallo

colours metal elements

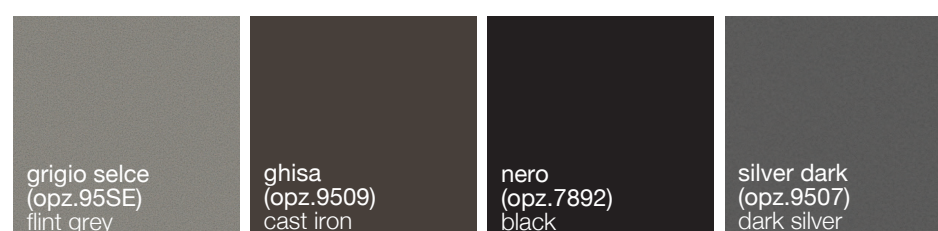

LIBRERIA "CODE"

"CODE" BOOKCASE



colori mensole colours shelves



colori montanti in metallo colours metal elements

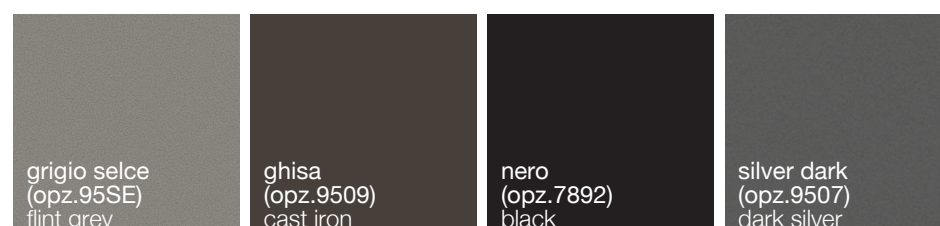

PENSILI A COLORAZIONE INTEGRALE CON STRUTTURA FOLDING

FULL COLOUR WALL UNITS WITH FOLDING CARCASS



colori per strutture e ante
colours for carcasses and doors

<p>larice bianco (opz.2414N) white larch</p>	<p>larice grigio lava (opz.2417N) lava grey larch</p>	<p>larice conchiglia (opz.2415N) shell larch</p>	<p>larice visone (opz.2416N) mink ash</p>	<p>larice nero (opz.2418N) black larch</p>	<p>olmo sabbia (opz.5077) sand elm</p>	<p>olmo tabacco (opz.5078) tobacco elm</p>
<p>olmo scuro (opz.5079) dark elm</p>	<p>olmo petrolio (opz.5080) oil elm</p>	<p>bianco ottico (opz.7465) optical white</p>	<p>grigio fossena (opz.9616) fossena grey</p>	<p>sabbia tenue (opz.7718) soft sand</p>	<p>daino (opz.9455) deer</p>	<p>terra bruna (opz.8845) brown earth</p>
<p>grigio laks (opz.9618) lakis grey</p>	<p>rosso sedona (opz.8132) sedona red</p>	<p>verde berillo (opz.8422) beryl green</p>	<p>grigio velato (opz.9600) veiled grey</p>	<p>blu dusty (opz.8324) blu dusty</p>	<p>malta bianco assoluto (opz.PM01N) absolute white mortar</p>	<p>malta grigio lava (opz.PM04) lava grey mortar</p>
<p>malta sabbia (opz.PM02N) sand mortar</p>	<p>malta visone (opz.PM03) mink mortar</p>	<p>malta grigio asfalto (opz.PM05) grey asphalt mortar</p>				

SCHIENALI "WEAVE" CON MENSOLE LACCATE OPACHE

"WEAVE" BACK PANELS WITH MATT LACQUERED SHELVES



COLORI FREDDI OPACHI SOFT SOFT MATT COLD COLOURS

bianco assoluto (opz.740S) absolute white	cenere (opz.9547) ash	argilla (opz.9503) clay	grigio bromo (opz.9533) bromine grey	nero seppia (opz.7897) cuttlefish ink	nebbia (opz.95F5) fog	grigio traffico (opz.9511) traffic grey
blu cristal (opz.8381) crystal blue	nero (opz.7892) black					

COLORI CALDI OPACHI SOFT SOFT MATT HOT COLOURS

bianco caldo (opz.7401) warm white	grigio kenya (opz.9501) kenya grey	bistro (opz.9535) bistro	cannella (opz.8893) cinnamon	grigio reale (opz.95F3) royal grey	grigio quarzo (opz.95F7) quartz grey	azzurro nube (opz.8379) cloud blue
conchiglia (opz.7403) seashell	lino (opz.9513) linen	creta (opz.9515) clay	rosso persia (opz.8165) persia red	giallo zafferano (opz.8253) saffron yellow	verde bosco (opz.8468) forest green	fumo (opz.9531) smoke
grigio lava (opz.95F1) lava grey	polvere (opz.9539) dust	platino (opz.7773) platinum	nociola (opz.7775) walnut	cuoio (opz.8897) leather	tortora (opz.8993) dove grey	rosso (opz.125S) red
grigio piombo (opz.9537) lead grey	carruba (opz.89L1) carruba	azzurro ottanio (opz.8385) teal blue	verde borneo (opz.8483) borneo green	verde cinabro (opz.8481) cinabro green	granato (opz.8633) ruby red	giallo digione (opz.8257) digione yellow
cotto (opz.8887) cooked	verde celadon (opz.8485) celadon green					

MOBILE DI FINITURA "SIDE"

"SIDE" FINISHING FURNITURE











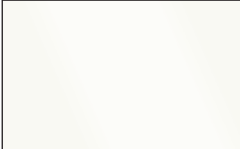













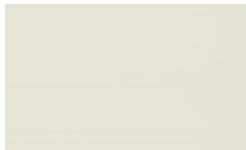



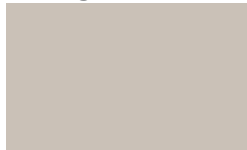

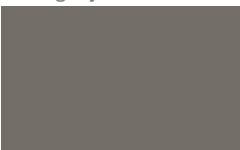
COLORI STRUTTURA E COLORI DIVISORI LACCATI OPACHI CARCASS COLOURS AND MATT LACQUERED DIVIDERS COLOURS



COLORI FREDDI OPACHI SOFT SOFT MATT COLD COLOURS



COLORI CALDI OPACHI SOFT SOFT MATT HOT COLOURS

COLORI DIVISORI VETRI GLASS DIVIDERS COLOURS

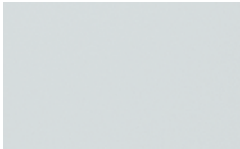
		
vetro satinato satin glass	vetro bronzo bronze glass	vetro fumè fumè glass

MOBILI PER LIVING "STYLE-R"

"STYLE-R" FURNITURE FOR LIVING



COLORI SCOCCA ESTERNA COLOUR FOR EXTERNAL CARCASS

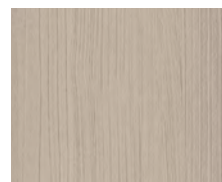

EFFETTO LEGNO MATERICO colori pag.9
TEXTURED WOOD EFFECT colours page 9

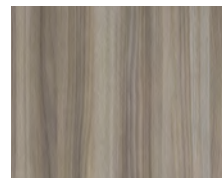

EFFETTO LEGNO colori pag.9
WOOD EFFECT colours page 9



TINTA UNITA OPACA colori pag.10
SOLID MATT COLOUR colours page 10



EFFETTO MALTA MATERICO colori pag.11
TEXTURED MORTAR EFFECT colours page 11

ANTE DOORS

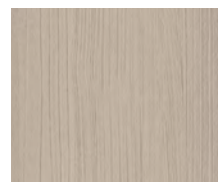

EFFETTO LEGNO MATERICO colori pag.9
TEXTURED WOOD EFFECT colours page 9

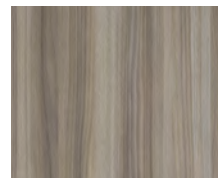

EFFETTO LEGNO colori pag.9
WOOD EFFECT colours page 9



TINTA UNITA OPACA colori pag.10
SOLID MATT COLOUR colours page 10



EFFETTO MALTA MATERICO colori pag.11
TEXTURED MORTAR EFFECT colours page 11



VETRI colori pagg.56-57
GLASSES colours pages 56-57

COLORI BASAMENTO COLOURS BASAMENT

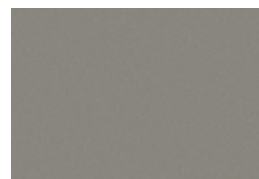

grigio selce (opz.SERB)
flint grey



ghisa (opz.GHRB)
cast iron



silver dark (opz.DARF)
dark silver

VIVI IL LIVING

LIVE THE LIVING

Con i nuovi pensili più profondi
è facilissimo creare composizioni living
adatte ad ogni spazio.

With new more deep wall units,
it's easy to create lively
furnishing compositions.



LIVING LR01



ANTA
door



STRUTTURA
carcass

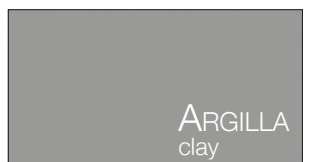

LIVING LR01

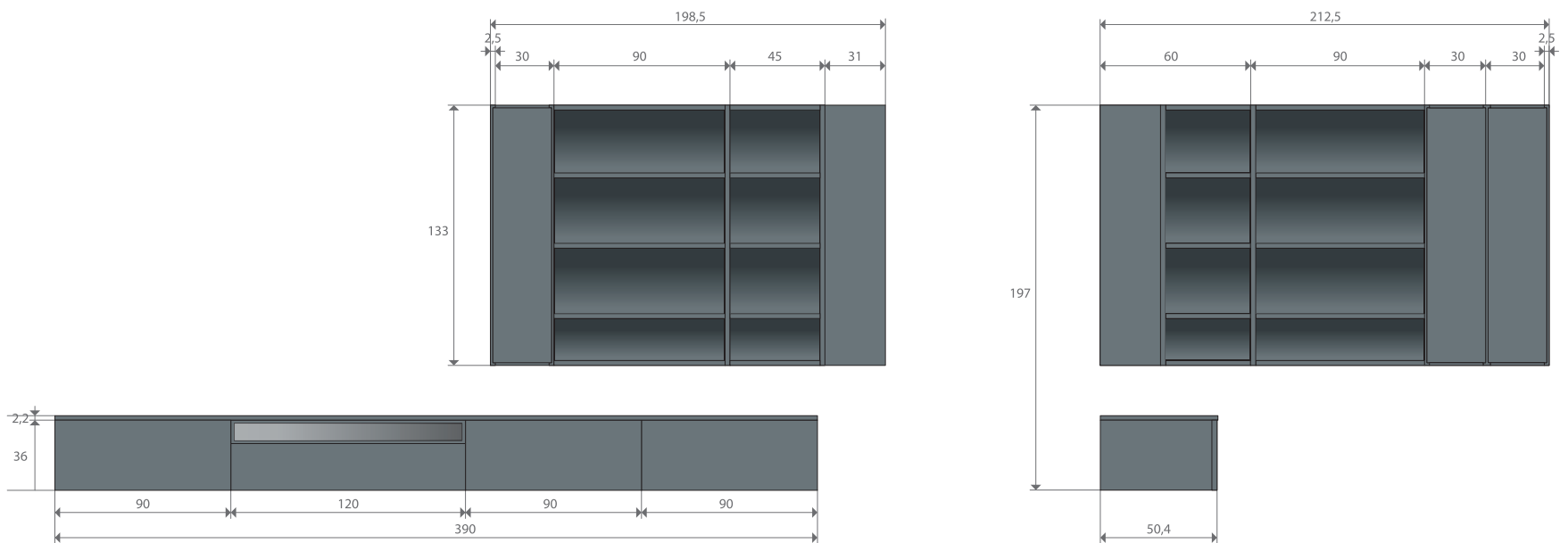

NR. ELEMENTI	DESCRIZIONE	CODICE
2	Base living sospesa L 90 H 36 P 50,4 cestone tip-on, 1 fianco come anta	EBL75900
1	Base living sospesa L 120 H 36 P 50,4 per decoder apertura vasistas	EBL77200
1	Base living sospesa L 90 H 36 P 50,4 cestone tip-on	EBL75900
1	Top L 210 H 2,2 P 50,6 in PET colore come anta	al ml TLM225
1	Top L 180 H 2,2 P 50,6 in PET colore come anta	al ml TLM225

No. of ELEMENTS	DESCRIPTION	CODE
2	Hanging living base unit W 90 H 36 D 50,4 deep drawer tip-on opening, 1 side same as door	EBL75900
1	Hanging living base unit W 120 H 36 D 50,4 flap door with infrared glass	EBL77200
1	Hanging living base unit W 90 H 36 D 50,4 deep drawer tip-on opening	EBL75900
1	PET worktop W 210 D 2,2 D 50,6 same colour as door	per lm TLM225
1	PET worktop W 180 D 2,2 D 50,6 same colour as door	per lm TLM225

LIVING A SPALLA LR01



ANTA
door



SCHIENA
back panel

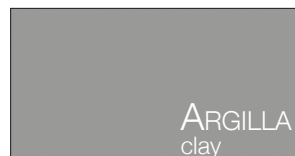

STRUTTURA
carcass

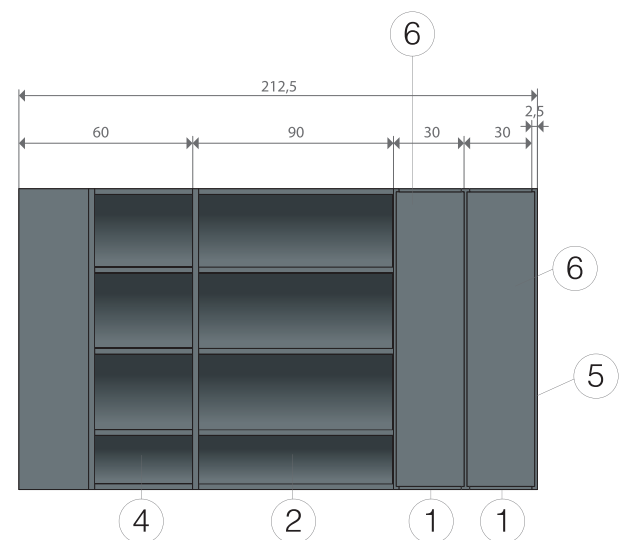
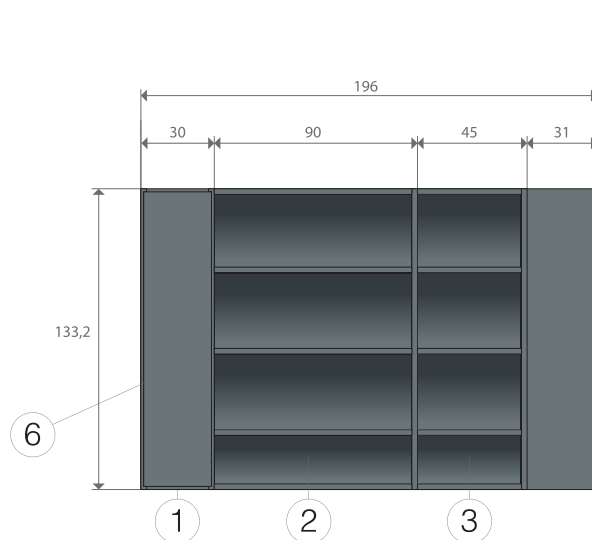
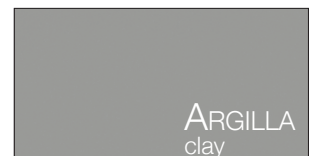

LIVING LR02



ANTE
doors



ELEMENTI A GIORNO
open units

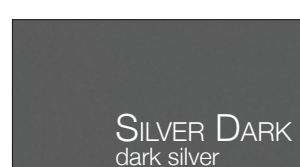

STRUTTURE
carcasses

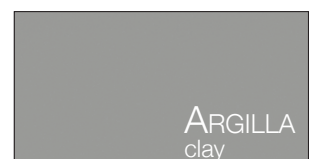

LIVING LR02

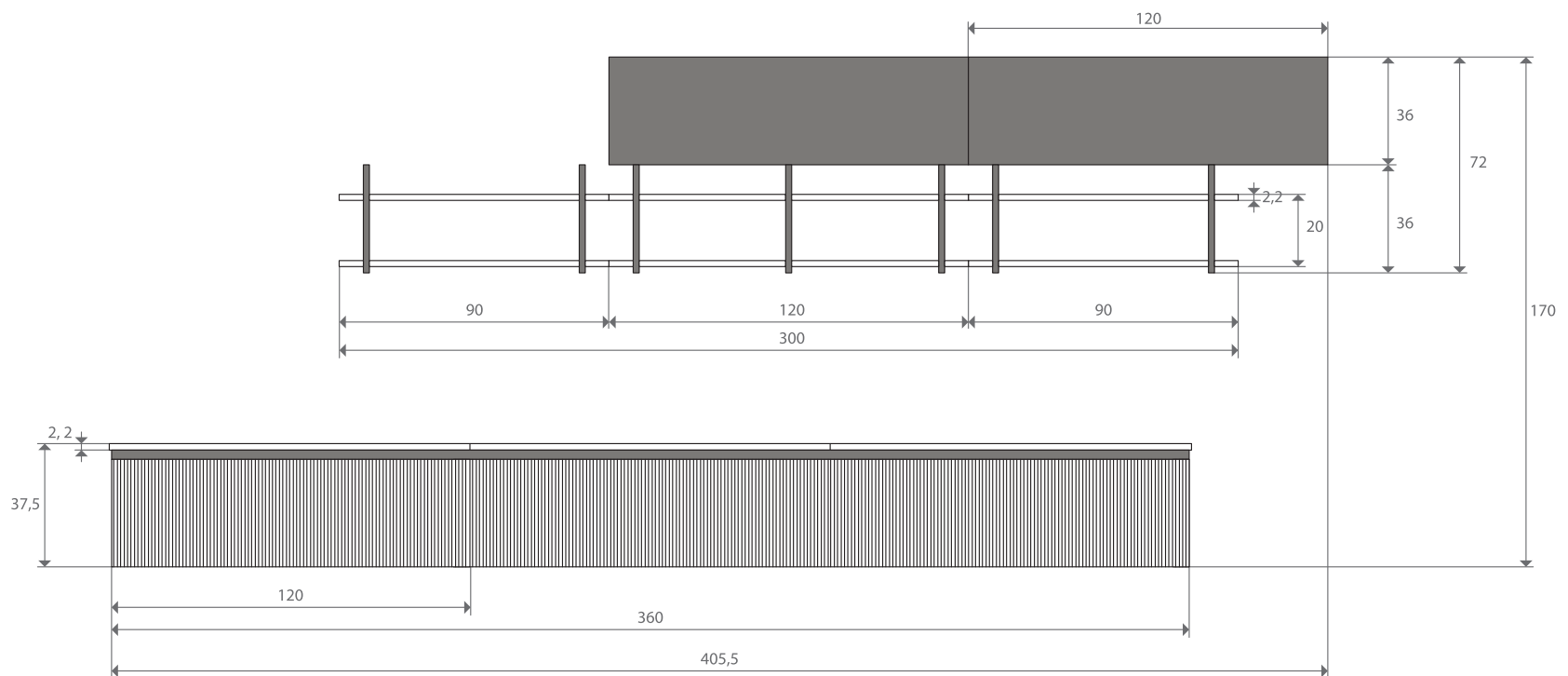

NR. ELEMENTI	DESCRIZIONE	CODICE
2	Pensile L 120 H 36 P 33,4 apertura tip-on, 1 fianco come anta	E210120T
2	Elemento "CODE" L 90 H 36 P 29	ECODE03609
1	Elemento "CODE" L 120 H 36 P 29	ECODE03612
2	Base living sospesa L 120 H 37,5 P 50,4 cestone, 1 fianco come anta	GBL76200
1	Base living sospesa L 120 H 37,5 P 50,4 cestone	GBL76200
1	Top L 240 H 2,2 P 50,6 in PET colore come anta	al ml TLM225
1	Top L 120 H 2,2 P 50,6 in PET colore come anta	al ml TLM225
2	Terminale aperto per gola	G950021/2
2	Asta appendipensili ml 2	08610501

No. of ELEMENTS	DESCRIPTION	CODE
2	Wall unit W 120 H 36 D 33,4 flap door tip-on opening, 1 side same as door	E210120T
2	"CODE" open unit W 90 H 36 D 29	ECODE03609
1	"CODE" open unit W 120 H 36 D 29	ECODE03612
2	Hanging living base unit W 120 H 37,5 D 50,4, deep drawer, 1 side same as door	GBL76200
1	Hanging living base unit W 120 H 37,5 D 50,4, deep drawer	GBL76200
1	PET worktop W 240 H 2,2 D 50,6 same colour as door	per lm TLM225
1	PET worktop W 120 H 2,2 D 50,6 same colour as door	per lm TLM225
2	Open end for finger rail	G950021/2
2	Wall unit fixing strip lm 2	08610501

COMPOSIZIONE L 305

COMPOSITION W 305



COMPOSIZIONE L 423

COMPOSITION W 423



COMPOSIZIONE L 305

COMPOSITION W 305

COMPONENTI COMPONENTS

Colonna 60 H 217 frigo-freezer 230 classe A+ con gola verticale e fianco come anta

60 cm column H 217 fridge-freezer 230 class "A+" with vertical finger rail and side as doors

Base 60

60 cm base unit

Base 60 forno multifunzione inox

60 cm base unit for stainless steel multifunctional oven

Piano cottura 60 4 gas inox con valvola

60 cm stainless steel hob with 4 burners with safety valve

Base 60 2 cassetti e cestone

60 cm base unit with 2 drawers and deep drawer

Sottolavello 60

60 cm sink unit

Lavello ad incasso 86 x 50 1 vasca inox

86x50 cm built-in sink with 1 stainless steel bowl

Top 240 P 61 in laminato H 4

240 cm laminate worktop D 61 H 4

Pensile 60 H 72

60 cm wall unit H 72

Cappa 60 "Mod. 29" H 72

60 cm hood "Mod.29" H 72

Pensile 60 H 72

60 cm wall unit H 72

Scolapiatti 60 H 72

60 cm plate rack H 72

Asta appendispensili ml 4

4 lm wall unit fixing strip

(Elettrodomestici Hotpoint)
(Hotpoint appliances)

VERSIONI VERSIONS

ROUND NECK

ROUND RAYÈ

ROUND LUX

COMPOSIZIONE L 423

COMPOSITION W 423

COMPONENTI COMPONENTS

Colonna 60 H 217 frigo-freezer 315 classe A+

60 cm column H 217 fridge-freezer 315 class "A+"

Colonna 60 H 217 forno multifunzione inox

60 cm column H 217 for stainless steel multifunctional oven

Base 60

60 cm base unit

Piano cottura 75 5 gas inox con valvola

75 cm stainless steel hob with 5 burners with safety valve

Base 90 2 cassetti e cestone predisposta piano cottura

90 cm base unit with 2 drawers and deep drawers configured for hob

Base 60

60 cm base unit

Sottolavello 90

90 cm sink unit

Lavello ad incasso 86 x 50 1 vasca inox

86x50 cm built-in sink with 1 stainless steel bowl

Top 300 P 61 in laminato H 4

300 cm laminate worktop D 61 H 4

Pensile 60 H 72

60 cm wall unit H 72

Cappa 90 "STILO" inox

90 cm "STILO" stainless steel hood

Pensile 60 H 72

60 cm wall unit H 72

Scolapiatti 90 H 72

90 cm plate rack H 72

Asta appendispensili ml 4

4 lm wall unit fixing strip

(Elettrodomestici Hotpoint)
(Hotpoint appliances)

VERSIONI VERSIONS

ROUND NECK

ROUND RAYÈ

ROUND LUX

COMPOSIZIONE L 300

COMPOSITION W 300



COMPOSIZIONE L 420

COMPOSITION W 420



COMPOSIZIONE L 300

COMPOSITION W 300

COMPONENTI COMPONENTS

Colonna 60 H 217 frigo-freezer 230 classe A+

60 cm column H 217 fridge-freezer 230 class "A+"

Base 60

60 cm base unit

Base 60 forno multifunzione inox

60 cm base unit for stainless steel multifunctional oven

Piano cottura 60 4 gas inox con valvola

60 cm stainless steel hob with 4 burners with safety valve

Base 60 2 cassetti e cestone

60 cm base unit with 2 drawers and deep drawer

Sottolavello 60

60 cm sink unit

Lavello ad incasso 86 x 50 1 vasca inox

86x50 cm built-in sink with 1 stainless steel bowl

Top 240 P 61 in laminato H 4

240 cm laminate worktop D 61 H 4

Pensile 60 H 72

60 cm wall unit H 72

Cappa 60 aspirante estraibile H 63

60 cm hood slide-out ducting H 63

Pensile 60 H 72

60 cm wall unit H 72

Scolapiatti 60 H 72

60 cm plate rack H 72

Asta appendipensili ml 4

4 lm wall unit fixing strip

(Elettrodomestici Hotpoint)

(Hotpoint appliances)

VERSIONI VERSIONS

ROUND BRIDGE

ROUND FRAME

ROUND AREA

ROUND BOX

COMPOSIZIONE L 420

COMPOSITION W 420

COMPONENTI COMPONENTS

Colonna 60 H 217 frigo-freezer 315 classe A+

60 cm column H 217 fridge-freezer 315 class "A+"

Colonna 60 H 217 forno multifunzione inox

60 cm column H 217 for stainless steel multifunctional oven

Base 60

60 cm base unit

Piano cottura 75 5 gas inox con valvola

75 cm stainless steel hob with 5 burners with safety valve

Base 90 2 cassetti e cestone predisposta piano cottura

90 cm base unit with 2 drawers and deep drawers configured for hob

Base 60

60 cm base unit

Sottolavello 90

90 cm sink unit

Lavello ad incasso 86 x 50 1 vasca inox

86x50 cm built-in sink with 1 stainless steel bowl

Top 300 P 61 in laminato H 4

300 cm laminate worktop D 61 H 4

Pensile 60 H 72

60 cm wall unit H 72

Cappa 90 "STILO" inox

90 cm "STILO" stainless steel hood

Pensile 60 H 72

60 cm wall unit H 72

Scolapiatti 90 H 72

90 cm plate rack H 72

Asta appendipensili ml 4

4 lm wall unit fixing strip

(Elettrodomestici Hotpoint)

(Hotpoint appliances)

VERSIONI VERSIONS

ROUND BRIDGE

ROUND FRAME

ROUND AREA

ROUND BOX